

Always. Reliable. Tight.

Connection wall sleeve

AFR 100/250

Article no.: 3030300006, GTIN: 4052487223874



• Integrated patch flange

For the direct connection of a smooth duct DN 110 with plug-in/glue-in socket.

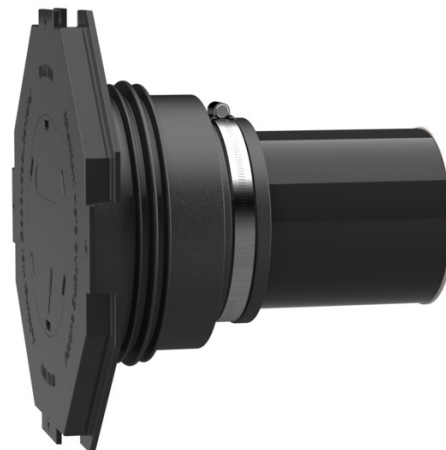

Picture may differ from selected product

FACTS

Application range:

- DIN 18533 W1.1-E, DIN 18533 W1.2-E, DIN 18533 W2.1-E
- Waterproof concrete stress class 1, Waterproof concrete stress class 2

Advantages:

- For the direct connection of a plug-in/glue-in socket DN 110
- Available adapted to wall thickness ready for installation
- Pressure-tight after concreting

Scope of delivery:

- Rubber sleeve with integrated 3-ribbed seal
- Clamping strap
- Sleeve cover with integrated patch flange and blind cover for tapping in
- Closing cover
- Plastic pipe DN 110 (everything pre-mounted ready for installation)

Properties:

- For installation flush with the formwork
- Blind sealed ready for installation

Material:

- Rubber sleeve: EPDM
- Sleeve cover: ABS
- Clamping strap: Steel St sn (W1)
- Closing cover: PE
- Pipe: PVC-U

Tightness:

- Gastight and watertight

FEATURES

Wall sleeve OD (mm) D1:	100
Wall sleeve OD (mm) D2:	110
Patch flange OD (mm) D4:	260
Patch flange OD (mm) d3:	290
Type:	PVC
Wall thickness (mm):	250
Packing unit (pieces):	5

PICTURES

