

# Connection wall sleeve

## AFR 100/365

Article no.: 3030300008, GTIN: 4052487223430



- **integrated flange connection**
- **pressure-sealed after concreting**

For the direct connection of a smooth duct DN 110 with plug-in/glue-in socket.

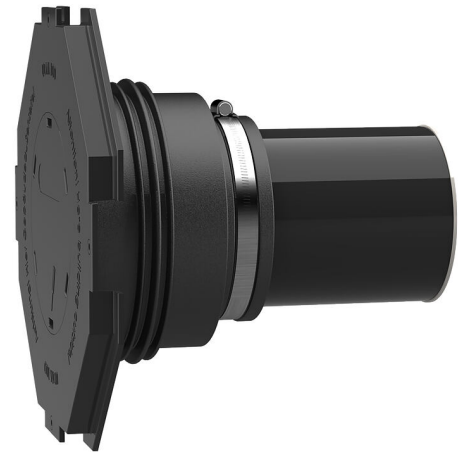

Picture may differ from selected product

## FACTS

### Advantages:

- For the direct connection of a plug-in/glue-in socket DN 110
- Delivered to the required wall thickness

### Scope of delivery:

- 1 piece of rubber sleeve with integrated 3-ribbed seal
- 1 piece of clamping strap
- 1 piece of sleeve cover with flange and blind cover for knock in
- 1 piece of closing cover
- 1 piece of plastic pipe DN 110 (everything pre-mounted ready for installation)

### Properties:

- for installation flush with the formwork
- Blind sealed and ready for installation



## Application range:

- Water exposure class DIN 18533: W1-E and W2.1-E
- Waterproof concrete stress class 1 and 2

## Material:

- Rubber sleeve: EPDM
- Sleeve cover: ABS
- Clamping strap: Steel St sn (W1)
- Closing cover: PE
- Pipe: PVC-U

## Tightness:

- gastight and watertight
- Radon-proof

## FEATURES

Wall sleeve ID (mm):	100
Wall sleeve OD (mm):	110
flange edge dimension (mm):	290
flange surface dimension (mm):	260
Wall thickness (mm):	365
Packing unit:	5

## PICTURES

