

Always. Reliable. Tight.

## Connection wall sleeve

AFR 100/250

Article no.: 3030300006, GTIN: 4052487143035



### • Integrated patch flange

For the direct connection of a smooth duct DN 110 with plug-in/glue-in socket.

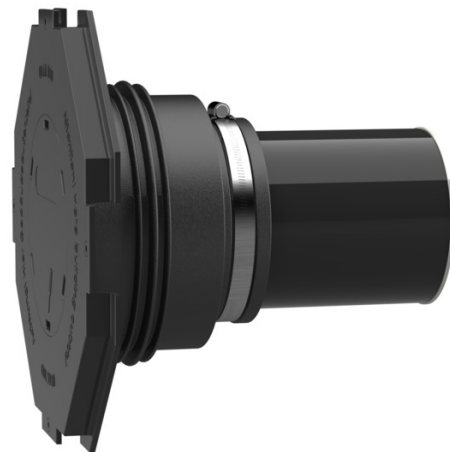

Picture may differ from selected product

## FACTS

### Application range:

- DIN 18533 W1.1-E, DIN 18533 W1.2-E, DIN 18533 W2.1-E
- Waterproof concrete stress class 1, Waterproof concrete stress class 2

### Advantages:

- For the direct connection of a plug-in/glue-in socket DN 110
- Available adapted to wall thickness ready for installation
- Pressure-tight after concreting

## Scope of delivery:

- Rubber sleeve with integrated 3-ribbed seal
- Clamping strap
- Sleeve cover with integrated patch flange and blind cover for tapping in
- Closing cover
- Plastic pipe DN 110 (everything pre-mounted ready for installation)

## Properties:

- For installation flush with the formwork
- Blind sealed ready for installation

## Material:

- Rubber sleeve: EPDM
- Sleeve cover: ABS
- Clamping strap: Steel St sn (W1)
- Closing cover: PE
- Pipe: PVC-U

## Tightness:

- Gastight and watertight

## FEATURES

Wall sleeve ID (mm) D1:	100
Wall sleeve OD (mm) D2:	110
Patch flange OD (mm) D4:	260
Patch flange OD (mm) d3:	290
Type:	PVC
Wall thickness (mm):	250

## PICTURES

