

Stainless steel flange split for retrofit dowelling

FAG1x80/80 A2

Article no.: 910910000, GTIN: 4052487021180

For dowelling through existing recesses/break-throughs in walls or floor slabs for media lines that have already been laid.

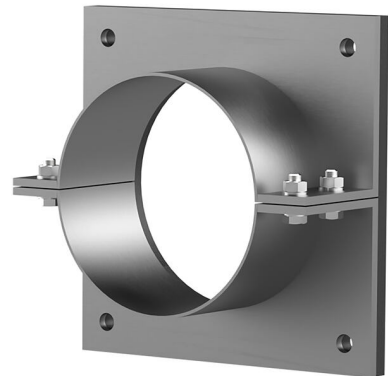

Picture may differ from selected product

FACTS

Advantages:

- Split design for media lines that have already been laid
- Tailor-made designs can also be produced
- Also available with multiple entries and in a variety of diameters

Scope of delivery:

- 1 piece of stainless steel flange
- 1 piece of surface seal
- Fastening elements

Dimensions:

- Standard flange dimensions OD equivalent to the corresponding wall sleeve ID + approx. 150 mm (for one entry, see the brochure for detailed information)
- Standard upper length: 80 mm

Application range:

- Water exposure class DIN 18533: W1-E and W2.1-E
- Waterproof concrete stress class 1 and 2

Material:

- Flange: stainless steel V2A (AISI 304L) or V4A (AISI 316L)
- Surface seal: EPDM
- Fastenings: stainless steel V4A (AISI 316L)

FEATURES

Wall sleeve ID (mm):	80
Wall sleeve wall thickness (mm) S:	2
Flange standard dimensions (mm):	170

PICTURES



ACCESSORIES REQUIRED



EGO sealant