

# Stainless steel flange split

## for retrofit dowelling

### FAG1x150/80 A2

: 910950000, GTIN: 4052487021227

For dowelling through existing recesses/break-throughs in walls or floor slabs for media lines that have already been laid.

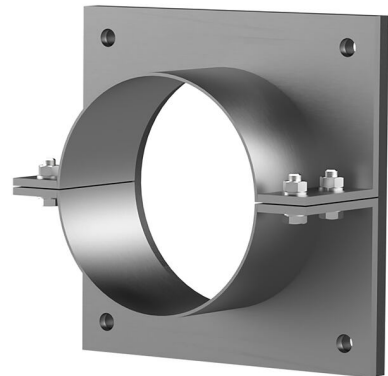

### Advantages:

- Split design for media lines that have already been laid
- Tailor-made designs can also be produced
- Also available with multiple entries and in a variety of diameters

### Scope of delivery:

- 1 piece Stainless steel flange
- 1 piece surface seal
- Fastenings

### Dimensions:

- Standard flange dimensions OD or  $\square$ a equivalent to the corresponding wall sleeve ID + approx. 150 mm (for one entry, see the brochure for detailed information)
- Standard upper length: 80 mm

## Application range:

- DIN 18533 W1-E, DIN 18533 W2.1-E
- Waterproof concrete stress class 1, waterproof concrete stress class 2

## Material:

- Flange: stainless steel V2A (AISI 304L) or V4A (AISI 316L)
- Surface seal: EPDM
- Fastenings: stainless steel V4A (AISI 316L)

Wall sleeve ID (mm): 150  
Wall sleeve wall thickness (mm) S: 2  
Flange standard dimensions (mm): 225

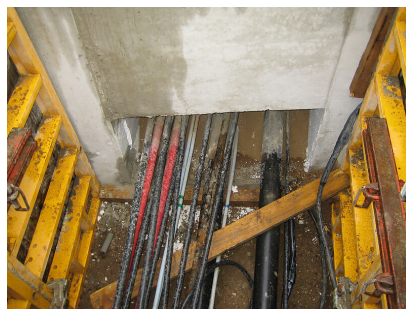

EGO sealant