

Universal wall entry without hem

UDM100/250 KG

: 3030300193, GTIN: 4052487220668



- **with integrated flange connection**
- **No change in flow direction**
- **Pressure-tight after concreting**

Optimized flow through wall penetration - prevents deposits and back water in the sewer system. The special construction makes it possible to convert standard KG (2000) pipes into wall bushings, adjusted for the wall thickness, on the building site itself. Can also be supplied prefabricated to wall thickness if required.

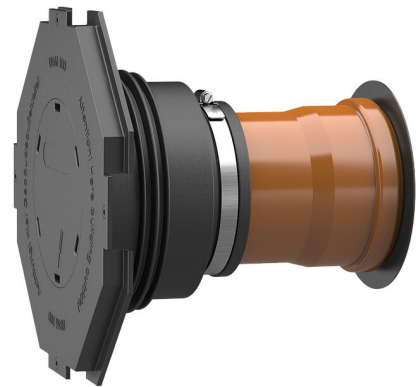

Advantages:

- Can be adapted to wall thickness on site or supplied already adapted to wall thickness
- quick and easy installation
- Ideal for stock-keeping



Scope of delivery:

- Sleeve: rubber sleeve, clamping strap, sleeve cover with flange connection and blind cover for tapping in, lamella plugs (pre-mounted)
- Set: rubber sleeve, clamping strap, sleeve cover with flange connection and blind cover for tapping in, lamella plugs and KG (2000) pipe (pre-mounted ready for installation)

Dimensions:

- DN 110: minimum wall thickness 200 mm
- DN 150: minimum wall thickness 240 mm

Properties:

- For installation flush with the formwork
- Blind sealed ready for installation
- Available for KG and KG 2000 pipes, DN 110 and DN 160

Application range:

- DIN 18533 W1-E, DIN 18533 W2.1-E
- Waterproof concrete stress class 1, waterproof concrete stress class 2

Material:

- Rubber sleeve: EPDM
- Sleeve cover: ABS
- Clamping strap: Steel St sn (W1)
- Lamella plugs: PE
- KG pipe: PVC-U/KG 2000 pipe: PP

Tightness:

- gastight and watertight
- radon tight

Tests/Standards:

- KG 2000 pipes to DIN EN 14758
- KG pipes to DIN EN 13476-2

Nominal diameter of KG pipe:	DN 100
Suitable for medium pipe OD (mm):	110 mm
wall thickness (mm):	250
Packing unit:	8

