

Catalogue International

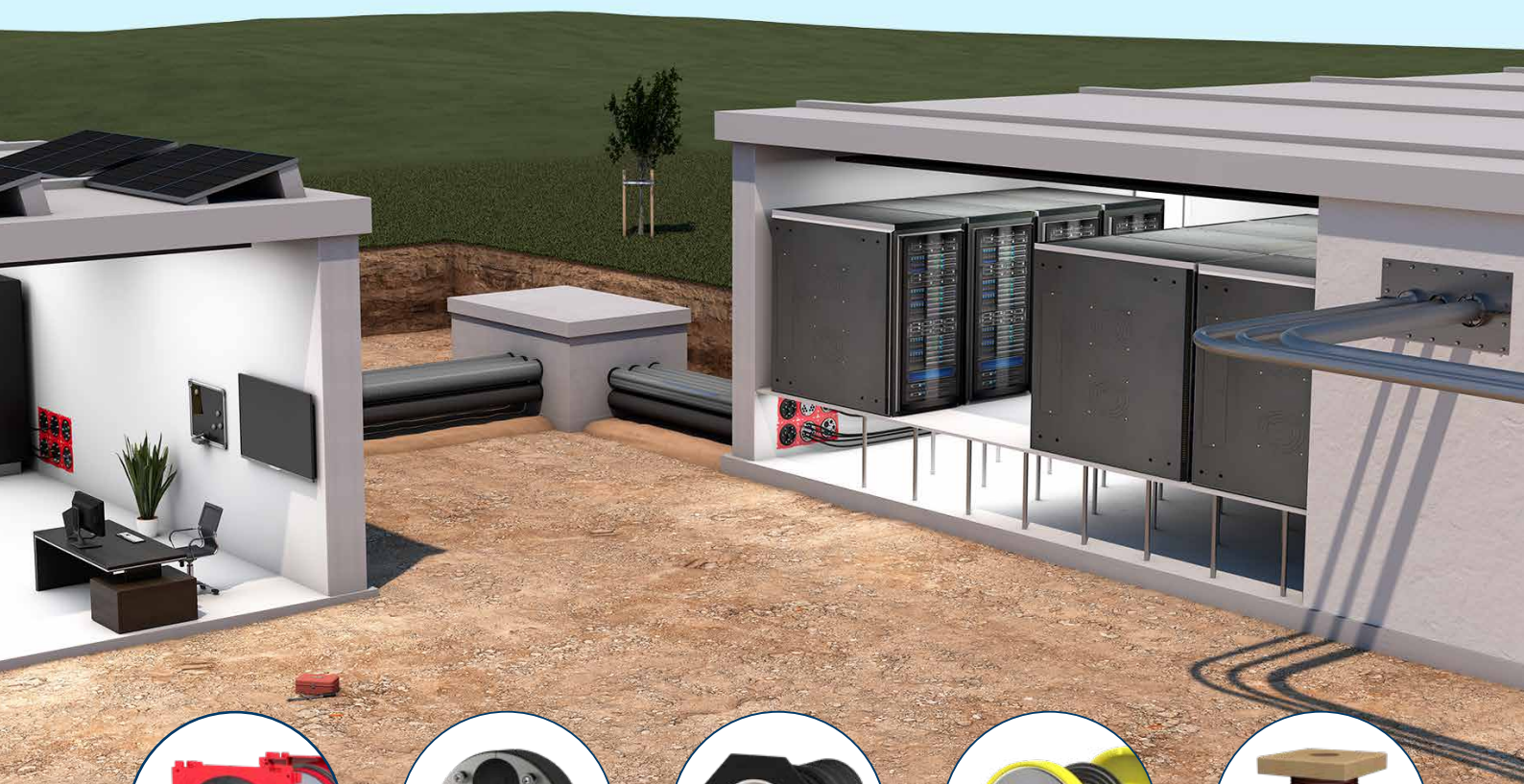

Cable entries, Wall sleeves, Press seals, Wastewater entries, Extra, Single building entries, Building services outlets and Infrastructure



The efficient solution builders.

We are one of Europe's leading manufacturers of sealing systems for cables, pipes and building entries.

Our innovative sealing systems protect your building from penetrating water, gas, fire, dirt and vermin. Our custom solutions guarantee you absolute leak tightness, economic efficiency, user friendliness and durability in all kinds of construction work. From detached houses to various construction services through to large infrastructure projects such as airports and power stations.

We offer them all the right solution to meet their unique challenges – either from our comprehensive product range or custom-built.

Your contacts for sales

Orders

Have you found some interesting products?
Please send your order to:
Email: ht.order@hauff-technik.de

Personalized advice

If you have any questions about our products, prices, terms and conditions, delivery conditions, or your order, our internal sales team will be happy to assist you.

Tel.: +49 (07322) 1333-520
Email: ht.international@hauff-technik.de

Do you require on-site support?

Our experienced field service team is available to assist you with issues that cannot be resolved over the phone or by email. You can find their contact details on our website.

Your contact in the field:

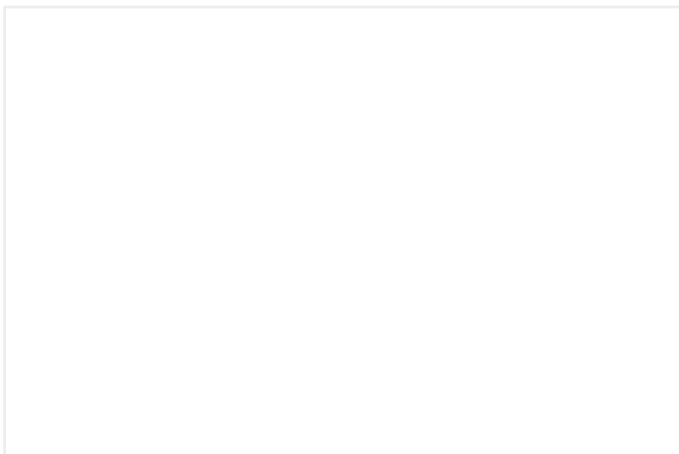

Quotation preparation

Would you like to receive a quotation from us?
Then send us your tender documents with details of the construction project, location, street/house number, and submission date. Alternatively, you can also call us.

Tel.: +49 (07322) 1333-520
Email: ht.international@hauff-technik.de

Planning support

Are you in the planning phase and need product advice or technical support in preparing your tender? Our planning support team will be happy to help.

Tel.: +49 (07322) 1333-520
Email: ht.international@hauff-technik.de

Or use our [planning tool](#) and find the right solutions for your project with just a few clicks.



Content

01 Cable entries

Cable entry system HSI150

- Wall inserts
 - Single wall inserts..... 8 – 11
 - External duct connection..... 12 – 16
 - Double wall inserts..... 16 – 24
 - Polymer flange..... 25 – 26
 - System covers and system seals..... 27 – 43
- Cable duct system KES
 - Inserts..... 44 – 45
 - Polymer spiral duct..... 46
 - Adaptation..... 47 – 50
 - Cable seals..... 51 – 54
 - Accessories..... 55 – 57

Cable entry system HSI90

- Wall inserts
 - Single wall inserts..... 58 – 60
 - External duct connection..... 61
 - Double wall inserts..... 62 – 64
 - Polymer flange..... 65
 - System covers and system seals..... 66 – 72
- Cable duct system KES
 - Inserts..... 73 – 74
 - Polymer spiral duct..... 75
 - Adaptation..... 76 – 79
 - Cable seals..... 80 – 81
 - Accessories..... 82 – 83

02 Wall sleeves

- Inserts and flanges / new construction
 - Wall sleeves..... 86 – 96
- Inserts and flanges / retrofit installation
 - Inserts..... 97 – 99
 - Flanges..... 100 – 101

03 Press seals

- For cables
 - Standard..... 104 – 109
 - Custom..... 110 – 115
 - For pipes..... 116 – 141

04 Pipe entries

- Wastewater entries
 - Floor..... 144 – 147
 - Wall entry..... 148 – 152
 - Compensating pipe seal..... 153

05 Extra

- Earthings
 - Earthing entries..... 156 – 164
 - Earthing fixed points..... 165 – 167
 - Roof entries..... 168 – 169
 - HFM foil sleeves..... 170 – 172
 - Fire protection..... 173 – 176
 - Accessories..... 177

06 Building entries

- Resin injection system..... 180 – 191
- Through the floor slab..... 192
- Accessories..... 193

07 Building services outlets

- Building services outlets ETGAR
 - Floor version..... 196 – 198
 - Wall version..... 199 – 200
 - Garden distribution..... 201 – 204
 - Accessories..... 205

08 Infrastructure

- EV Charging..... 208 – 209
- Street Lighting..... 210 – 211



Symbols

In a world with an increasing number of standards and regulations to comply with, we would like to simplify your product selection process by using symbols. This allows you to see whether the product is suitable for your application.



This product is radon proof.

In Europe the Directive for protection against the dangers arising from ionising radiation (COUNCIL DIRECTIVE 2013/59/EURATOM OF 5 DECEMBER 2013), obliges the member states to ensure that appropriate measures are in place to prevent radon ingress into new buildings.

The statutory reference value in workplaces and dwellings is 300 Bq/m³. Many of our Hauff products have already been tested for radon tightness.



This product has been awarded the „FHRK Quality“ seal in accordance with the FHRK testing guidelines.

Given the huge number of suppliers and manufacturers of sealing solutions, it is easy to quickly feel overwhelmed.

What seals will meet my needs?
Do they meet quality standards?
And what do these standards look like anyway?

Because up to now there have been no standards or guidelines for pipe and cable seals. The Fachverband für Rohre und Kabel e.V. (Association for House Entries for Cables and Pipes) has addressed precisely this topic and come up with uniform standards. The result is comprehensive and uniform testing guidelines devised in cooperation with expert representatives and the manufacturing industry. This synergy effect has made it possible to cover all needs and requirements for sealing solutions. What does this mean for you? Quite simply, greater safety, higher quality and better comparability for products that you can trust in.



This product contains regranulate.

In order to make our product world more sustainable, we are focussing on recycled plastic and thus taking an important step towards a closed material cycle and the conservation of resources. Despite the switch to regranulates, we can still guarantee our high quality standards, identical functionality and the durability of our products.



This product is DVGW-certified.

All house connections with this mark have been tested and approved in accordance with DVGW VP601. This ensures that our products meet all requirements for gas and pressure water tightness and that you receive a standardised and safe product. The valid type examination certificate from DVGW CERT GmbH can be found for each product on our website under Downloads.

Stress classes

Stress class 1	Stress class 2
<p>pressing water</p> <ul style="list-style-type: none"> groundwater, stratum water, flood water or other water that exerts hydrostatic pressure (temporarily or permanently) 	<p>non-standing seepage water</p> <ul style="list-style-type: none"> water that can seep through highly permeable soils ($k_f \geq 10^{-4}$ m/s) without accumulating water which is drained away in permeable soils by permanently functioning drainage in accordance with DIN 4095
<p>non-pressing water</p> <ul style="list-style-type: none"> water in liquid, dripping form with hydrostatic pressure (head of water ≤ 10 cm) 	<p>oil moisture</p> <ul style="list-style-type: none"> capillary-bound water in the soil
<p>occasionally standing seepage water</p> <ul style="list-style-type: none"> water that can accumulate on low-permeability soil strata without drainage. Foundation level of the building lies at least 30 cm above the water level assumed for design purposes 	

WU concrete according to DIN 1045 (waterproof concrete)

Cellar wall type/ Wall structure	without thermal insulation	with thermal insulation
Concrete basement with waterproof concrete	<p>— concrete cellar</p>	<p>— concrete cellar — thermal insulation</p>
Double/element wall with waterproof concrete	<p>— Double/ element wall</p>	<p>— Double/ element wall — thermal insulation</p>

If the wall types differ, please send us a sketch.

Fresh concrete composite membranes (FBV systems) as additional measures for waterproof concrete building waterproofing:

FBV systems are not part of DIN 18533 and the waterproof concrete guideline and must be planned and used as a separate construction type. Tested FBV connection joints available on request.

01 Cable entry system HSI150/HSI90

The HSI cable entry system impresses thanks to its modular design.

The system is available in two sizes with a nominal diameter of 150 or 90 mm and sets the standard for cable entries for installations flush with the formwork in concrete walls. Here, the wall insert HSI150/HSI90 offers maximum flexibility during retrofit use and is fitted with a pressure-tight closing cover ex works.

A variety of system seals are available for sealing cables – in closed or split versions, depending on the requirements – and for pressure-tight duct connections.

Hauff-Technik also offers the KES150/KES90 pressure-tight cable duct system, which is compatible with the HSI150/HSI90 system and features a Hateflex duct as well as various options for cable sealing. This system can be relied upon to provide optimum protection for the cables that are being laid.



Cable duct system KES150/KES90

Over the course of its life, a building frequently gets renovated or refurbished. In most cases, however, these activities only take place in the parts of the building located above ground level. Nonetheless, the requirements for the cable infrastructure in a building can also change significantly over time. This is precisely where it is recommendable during construction of a building to provide for reserve openings and lay a durable empty conduit route via which lines can be replaced or new lines laid without having to dig up the entire conduit route.

For this purpose, Hauff-Technik offers the KES150/KES90 pressure-tight cable duct system, which is compatible with the HSI150/HSI90 system and features a Hateflex duct as well as various options for cable sealing. This system can be relied upon to provide optimum protection for the cables that are being laid.

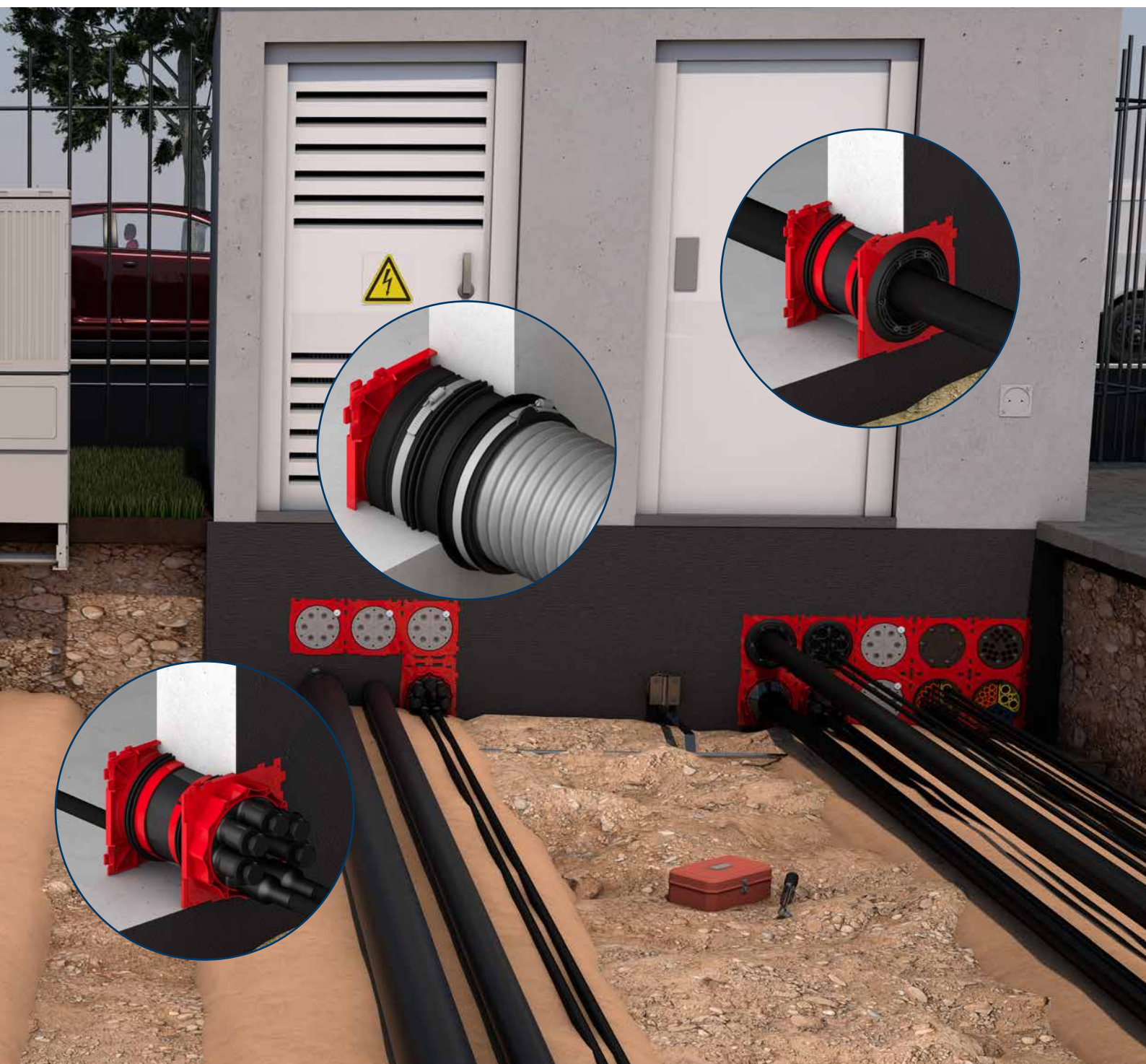

Single wall insert

for setting in concrete

HSI150 K/X

For the gas-tight and watertight connection on one side of system seals for cables or cable ducts, providing high flexibility for future use.



USP

- Double security with closing cover and blind plate for wall thicknesses from 70 to 150 mm
- injection molded 3-ribbed seal for pressure-tight seal to the concrete
- factory-sealed with quality label - for control against accidental or unauthorized opening of the closing cover

Scope of delivery

- 1 piece pressure-tight closing cover

Dimensions

- Frame dimensions: 220x 220 mm
- Centre to centre distance: 210 mm
- Minimum wall thickness: 70 mm

Tightness

- gastight and watertight to 2.5 bar
- radon-proof



Wall thickness (mm)	Article code	Article number	GTIN
100	HSI150 1x1 K/100	3030303428	4052487223164
120	HSI150 1x1 K/120	3030303363	4052487222938
150	HSI150 1x1 K/150	3030303361	4052487222921
200	HSI150 1x1 K/200	3030303430	4052487223171
250	HSI150 1x1 K/250	3030303434	4052487223195

Price for wall thickness up to 500 mm. Price on request for wall thickness > 500 mm.
The article numbers, article codes and GTINs for the exact wall thicknesses can be found at: www.hauff-technik.com

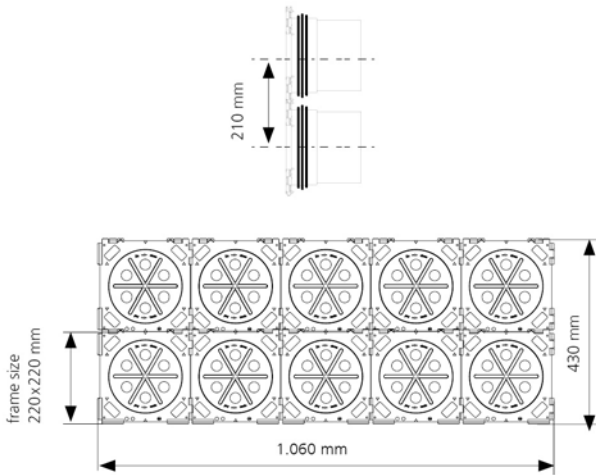

Order example as package 2x5 for wall thickness 200 mm. Order code: HSI150 2x5 K/200 (single seal pack) or HSI150 2x5 K2/200 (double seal pack)



Slanted single wall insert

for setting in concrete

HSI150 1xZ K S_°/X

For slanted cable entries Allows an optimal bending radius for feeding and sealing cables or connecting cable ducts.



USP

- injection molded 3-ribbed seal for pressure-tight seal to the concrete
- factory-sealed with quality label - for control against accidental or unauthorized opening of the closing cover

- Mounting frame
- 1 piece pressure-tight closing cover

Dimensions

- Centre to centre distance: 210 mm

Tightness

- gastight and watertight to 2.5 bar
- radon-proof



Scope of delivery

- 1 piece polystyrene wedge

Installation angle	Minimum wall thickness (mm)	Article code
30 °	180	HSI150 1xZ K S30°/X¹⁾
45 °	210	HSI150 1xZ K S45°/X¹⁾

¹⁾ Article number and GTIN on request

Z = number of columns (1-6), X = wall thickness (mm, 180-230)

Minimum concrete cover thickness of 200 mm according to WU-Richtlinie (Merkblatt H10) is only achieved with wall inserts HSI150 K S30° at a minimum wall thickness of 350 mm (S45° - 400 mm).

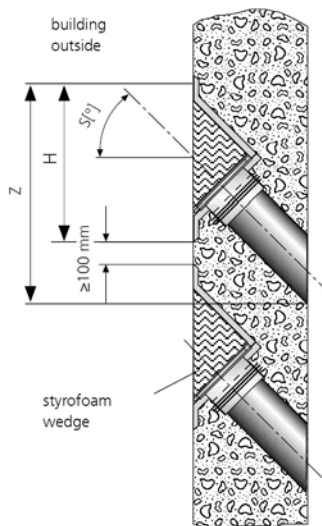

section 2x HSI150 1xZ K S45°/X single wall insert

Single wall insert with flange

for setting in concrete

HSI150 1xZ K AF/X

For the gas-tight and watertight connection on one side of system seals for cables or cable ducts, providing high flexibility for future use.



Cable entries

USP

- flange for easy application of polymer-modified bitumen thick coatings
- Tested solution for use with pre-applied waterproofing membrane
- 1x1 or 1x4 package arrangement
- factory-sealed with quality label - for control against accidental or unauthorized opening of the closing cover

Scope of delivery

- 1 piece pressure-tight closing cover

Dimensions

- Frame dimensions 1x1 package configuration: 340 x 340 mm
- Frame dimensions 1x4 package configuration: 970 x 340 mm
- Minimum wall thickness: 100 mm

Tightness

- gastight and watertight to 2.5 bar
- radon-proof



Figure	Minimum wall thickness (mm)	Article code
	100	HSI150 1x1 K AF/X
	100	HSI150 1x4 K AF/X

X = wall thickness (mm)

Price for wall thickness up to 500 mm. Price on request for wall thickness > 500 mm.

The article numbers, article codes and GTINs for the exact wall thicknesses can be found at: www.hauff-technik.com



Single wall insert with foldable rubber sleeve

for setting in concrete and connecting cable ducts



HSI150 KMA

For the direct connection of cable ducts (exterior) and for connecting system seals for cables (interior).

USP

- thanks to the folding sleeve technique, no additional pipe connection components are needed
- elastic and firmly supported connection due to increased insertion depth, even with deflection of the cable duct
- Installation of cable seals on the inside possible

- 1 piece blind cover
- 2 pieces of HSI150 AH40 spacer
- 1 piece of clamping strap
- When connecting corrugated cable ducts, clip rings must be ordered separately. When ordering, please specify duct type and manufacturer.



Dimensions

- Frame dimensions: 220x 220 mm
- Centre distance with spacer: 250 mm

Scope of delivery

- 1 piece pressure-tight system cover HSI150 DTS

Tightness

- gastight and watertight to 2.5 bar
- radon-proof

Pipe OD	Wall thickness (mm)	Article code	Article number	GTIN
110-127	120	HSI150 1x1 KMA127/120	3030614045	4052487250610
110-127	140	HSI150 1x1 KMA127/140	3030642651	4052487250627
110-127	150	HSI150 1x1 KMA127/150	3030618654	4052487250634
110-127	200	HSI150 1x1 KMA127/200	3030642690	4052487250641
110-127	250	HSI150 1x1 KMA127/250	3030642699	4052487250658
110-127	300	HSI150 1x1 KMA127/300	3030642701	4052487250665
110-127	350	HSI150 1x1 KMA127/350	3030643077	4052487250672
110-127	400	HSI150 1x1 KMA127/400	3030642702	4052487250689
110-127	450	HSI150 1x1 KMA127/450	3030643066	4052487250696
110-127	500	HSI150 1x1 KMA127/500	3030643076	4052487250702
160-172	120	HSI150 1x1 KMA172/120	3030476250	4052487242103
160-172	140	HSI150 1x1 KMA172/140	3030477593	4052487242127
160-172	150	HSI150 1x1 KMA172/150	3030477595	4052487242134
160-172	200	HSI150 1x1 KMA172/200	3030476251	4052487242110
160-172	250	HSI150 1x1 KMA172/250	3030477597	4052487242141
160-172	300	HSI150 1x1 KMA172/300	3030477598	4052487242158
160-172	350	HSI150 1x1 KMA172/350	3030477599	4052487242165
160-172	400	HSI150 1x1 KMA172/400	3030477600	4052487242172
160-172	450	HSI150 1x1 KMA172/450	3030477601	4052487242189
160-172	500	HSI150 1x1 KMA172/500	3030477602	4052487242196

Other wall thicknesses available on request.



HSI150 KMA, single sealing packing with hinged rubber sleeve, Hateflex connection



HSI150 KMA, single seal packing with hinged rubber sleeve

Single wall insert with plug-in socket

for setting in concrete and connecting smooth cable ducts



HSI150 GSM

For the one-sided connection of system seals for cables (inside) and for connecting cable ducts (outside).

USP

- injection molded 3-ribbed seal for pressure-tight seal to the concrete
- available from wall thickness of 120 mm (GSM 110 and GSM 125)
- factory-sealed with quality label - for control against accidental or unauthorized opening of the closing cover

Scope of delivery

- 1 piece pressure-tight closing cover



Dimensions

- Frame dimensions: 220x 220 mm
- Centre distance: 210 mm, spacer increases centre distance to 250 mm

Tightness

- gastight and watertight to 0.5 bar
- radon-proof



Figure	Minimum wall thickness (mm)	Article code
	120	HSI150 1x1 GSM110/X¹⁾
	120	HSI150 1x1 GSM125/X¹⁾
	160	HSI150 1x1 GSM160/X¹⁾

¹⁾ Restrictions regarding number and size of cables may apply

X = wall thickness (mm)

Price for wall thickness up to 500 mm. Price on request for wall thickness > 500 mm.

The article numbers, article codes and GTINs for the exact wall thicknesses can be found at: www.hauff-technik.com



Single wall insert with plug-in socket

adjustable length, for setting in concrete and connecting smooth cable ducts



Cable entries

HSI150 GSM Varia

For the one-sided connection of system seals for cables (inside) and for connecting cable ducts (outside).

USP

- stepless adjustment to the required wall thickness on site
- injection molded 3-ribbed seal for pressure-tight seal to the concrete
- factory-sealed with quality label - for control against accidental or unauthorized opening of the closing cover

Scope of delivery

- 1 piece pressure-tight closing cover
- 1 hex key with integrated torque limiter

Dimensions

- Minimum wall thickness OD 110, 125mm: 200 mm
- Minimum wall thickness OD 160mm: 260 mm
- Centre distance: 210 mm, spacer increases centre distance to 250 mm
- Frame dimensions: 220x 220 mm

Tightness

- gastight and watertight to 0.5 bar
- radon-proof



Figure	Pipe OD (mm)	Wall thickness (mm)	Article code	Article number	GTIN
	110	200-260	HSI150 1x1 GSM110 Varia 200-260	2120206120	4052487153577
		260-365	HSI150 1x1 GSM110 Varia 260-365	2120206126	4052487153584
		365-470	HSI150 1x1 GSM110 Varia 365-470	2120206136	4052487153591
		470-575	HSI150 1x1 GSM110 Varia 470-575	2120206147	4052487153607

Figure	Pipe OD (mm)	Wall thickness (mm)	Article code	Article number	GTIN
	125	200-260	HSI150 1x1 GSM125 Varia 200-260	2120206220	4052487153614
		260-365	HSI150 1x1 GSM125 Varia 260-365	2120206226	4052487153621
		365-470	HSI150 1x1 GSM125 Varia 365-470	2120206236	4052487153638
		470-575	HSI150 1x1 GSM125 Varia 470-575	2120206247	4052487153645

Figure	Pipe OD (mm)	Wall thickness (mm)	Article code	Article number	GTIN
	160	260-320	HSI150 1x1 GSM160 Varia 260-320¹⁾	2120206326	4052487153652
		320-425	HSI150 1x1 GSM160 Varia 320-425¹⁾	2120206332	4052487153669
		425-530	HSI150 1x1 GSM160 Varia 425-530¹⁾	2120206342	4052487153676
		530-565	HSI150 1x1 GSM160 Varia 530-635¹⁾	2120206353	4052487153683

¹⁾ block assembly only in conjunction with spacer

Including hex key for adjusting the installation length.

When installing packages of HSI150 wall insert, we recommend the use of spacer HSI AH40 for increasing the axial spacing. In case of GSM160 it is mandatory to use the spacer.



HSI150 GSM Varia applied as a block

Accessories

Figure	Item	Article code	Article number	GTIN
	Spacer	HSI AH40 SET2	3030300093	4052487220156

Double wall insert

for setting in concrete

HSI150 K2/X

For the gas-tight and watertight connection on both sides of system seals for cables or cable ducts, providing high flexibility for future use.



USP

- injection molded 3-ribbed seal for pressure-tight seal to the concrete
- factory-sealed with quality label - for control against accidental or unauthorized opening of the closing cover

Scope of delivery

- 2 pieces of pressure-tight closing covers

Dimensions

- Frame dimensions: 220x 220 mm (per wall insert)
- Centre to centre distance: 210 mm
- Minimum wall thickness: 100 mm

Tightness

- gastight and watertight to 2.5 bar
- radon-proof



Wall thickness (mm)	Article code	Article number	GTIN
120	HSI150 1x1 K2/120	3030304232	4052487243933
150	HSI150 1x1 K2/150	3030303369	4052487210799
200	HSI150 1x1 K2/200	3030303353	4052487222907
250	HSI150 1x1 K2/250	3030303394	4052487222952
300	HSI150 1x1 K2/300	3030303178	4052487222846

Price for wall thickness up to 500 mm. Price on request for wall thickness > 500 mm. The article numbers, article codes and GTINs for the exact wall thicknesses can be found at: www.hauff-technik.com

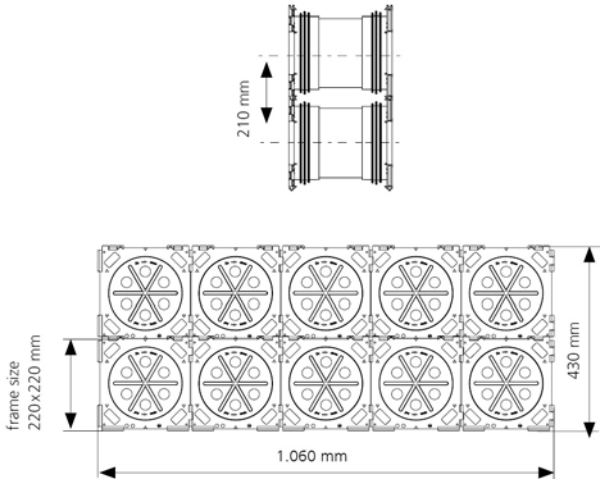

Double wall insert

adjustable length, for setting in concrete

HSI150 K2 Varia

For the gas-tight and watertight connection on both sides of system seals for cables or cable ducts, providing high flexibility for future use.

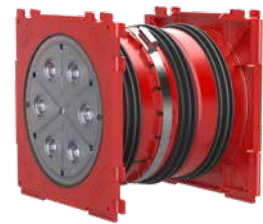

USP

- stepless adjustment to the required wall thickness on site
- pressure-tightness to concrete using three injection molded 3-ribbed seals
- factory-sealed with quality label - for control against accidental or unauthorized opening of the closing cover

Scope of delivery

- 2 pieces of pressure-tight closing covers

- 1 hex key with integrated torque limiter

Dimensions

- Frame dimensions: 220x 220 mm
- Centre to centre distance: 210 mm
- Minimum wall thickness: 200 mm

Tightness

- gastight and watertight to 2.5 bar
- radon-proof



Wall thickness (mm)	Article code	Packing unit	Article number	GTIN
200-260	HSI150 1x1 K2 Varia 200-260	1	3030300084	4052487135009
260-365	HSI150 1x1 K2 Varia 260-365	1	3030300085	4052487134231
365-470	HSI150 1x1 K2 Varia 365-470	1	3030300086	4052487140430
470-575	HSI150 1x1 K2 Varia 470-575	1	3030300087	4052487140454

Including hex key for adjusting the installation length.

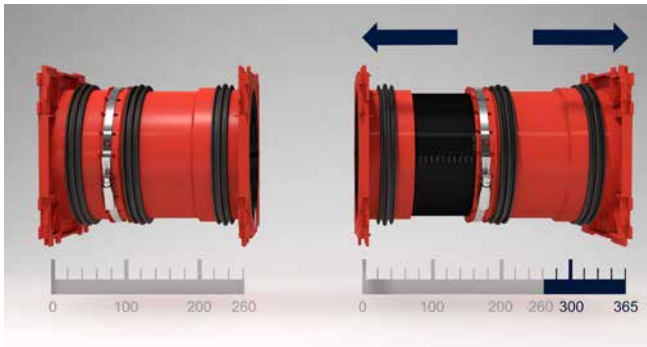
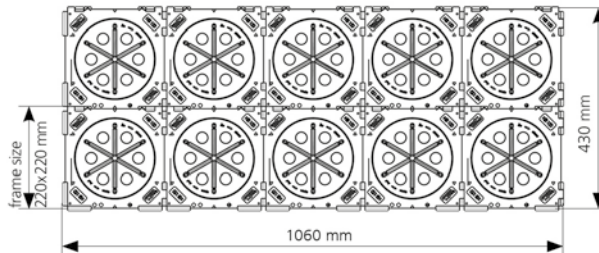
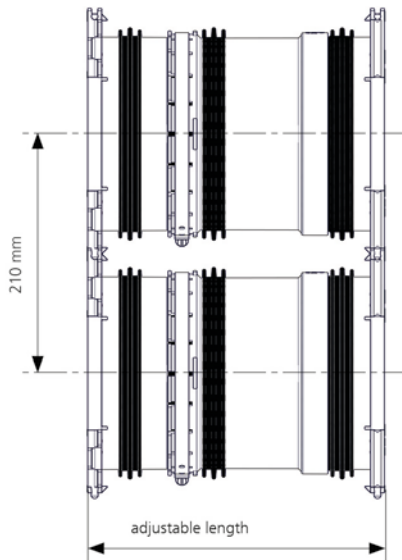

continuously adjustable to the required wall thickness, example HSI150 1x1 K2 Varia 260-365



Accessories

Figure	Item	Article code	Article number	GTIN
	Spacer	HSI AH40 SET2	3030300093	4052487220156

Double slanted wall insert

for setting in concrete

HSI150 1xZ K2 S₋°/X



For slanted cable entries Allows an optimal bending radius for feeding and sealing cables or connecting cable ducts.

USP

- injection molded 3-ribbed seal for pressure-tight seal to the concrete
- factory-sealed with quality label - for control against accidental or unauthorized opening of the closing cover

Scope of delivery

- 2 pieces of polystyrene wedges

- Mounting frame
- 2 pieces of pressure-tight closing covers

Dimensions



- Frame dimensions: 220x 220 mm
- Centre to centre distance: 210 mm

Tightness

- gastight and watertight to 2.5 bar
- radon-proof



Double slanted wall insert

Figure	Installation angle	Minimum wall thickness (mm)	Article code
	30 °	240	HSI150 1xZ K2 S30°/X¹⁾
	45 °	250	HSI150 1xZ K2 S45°/X¹⁾
	60 °	300	HSI150 1xZ K2 S60°/X¹⁾

¹⁾ Article number and GTIN on request

Z = number of columns (1-6), X = wall thickness (mm, 180-230)

Minimum concrete cover of 200 mm as per WU guideline (Merkblatt H10) is achieved with inclined seal pack HSI150 K2 S30° only from a wall thickness of 342 mm (S45° - 385 mm, S60° - 420 mm).

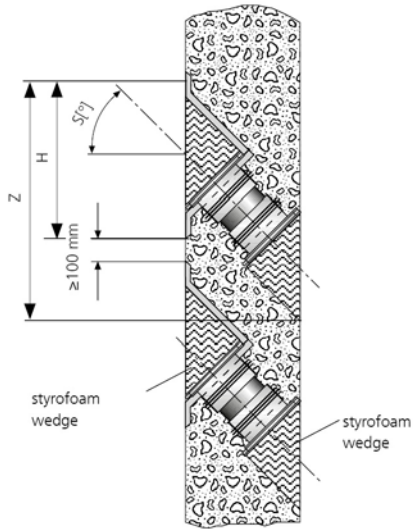

section 2x HSI150 1xZ K2 S45°/X double wall insert



Double wall insert with flange

for setting in concrete



HSI150 1xZ K2 AF/X

For the gastight and watertight connection on both sides of system seals for cables or cable ducts, providing high flexibility for future use.

USP

- flange for easy application of polymer-modified bitumen thick coatings
- Tested solution for use with pre-applied waterproofing membrane
- 1x1 or 1x4 package arrangement
- factory-sealed with quality label - for control against accidental or unauthorized opening of the closing cover

Scope of delivery

- 2 pieces of pressure-tight closing covers



Dimensions

- Frame dimensions 1x1 package configuration: 340 x 340 mm
- Frame dimensions 1x4 package configuration: 970 x 340 mm
- Minimum wall thickness 140 mm

Tightness

- gastight and watertight to 2.5 bar
- radon-proof

Figure	Article code
	HSI150 1x1 K2 AF/X
	HSI150 1x4 K2 AF/X

X = wall thickness (mm)

Price for wall thickness up to 500 mm. Price on request for wall thickness > 500 mm.

The article numbers, article codes and GTINs for the exact wall thicknesses can be found at: www.hauff-technik.com



Double wall insert

for setting in concrete, for black tank with fixed/loose flange

HSI150 FLFE/X DIN18533 W2-E



For cable entries or the connection of cable ducts in buildings with waterproof sheeting or approved plastic-modified thick coatings (PMBC). A transition from the building seal to the entry is achieved with the fixed/loose flange construction. Sealing is performed according to DIN 18533 (black tank).

USP

- factory-sealed with quality label
- for control against accidental or unauthorized opening of the closing cover

Dimensions

- 555 x 555 mm, for package configuration each additional entry + 250 mm

Tightness

- gastight and watertight

Figure	Configuration	Article code
	Y, Z, X = individuell	HSI150 YxZ FLFE/X¹⁾
	Y = 1, Z = 1, X = individuell	HSI150 1x1 FLFE/X¹⁾
	Y = 1, Z = 2, X = individuell	HSI150 1x2 FLFE/X¹⁾
	Y = 1, Z = 3, X = individuell	HSI150 1x3 FLFE/X¹⁾

¹⁾ Individual order designation: Available on request as a package with several feedthroughs next to and on top of each other. The article numbers, article codes and GTINs for the exact wall thicknesses can be found at: www.hauff-technik.com
Y = number of rows (1-10), z = number of columns (1-10), X = wall thickness (mm, 200-500)

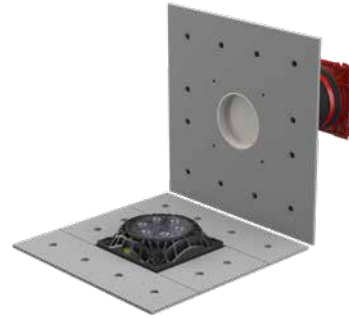

double wall insert HSI150 1x1 FLFE/X (front view). Fixed/loose flange for setting in concrete with sealing flange for connecting system seal.



concreted fixed flange of the double wall insert HSI150 2x2 FLFE/X

Polymer flange

for retrofit installation

HSI150 DFK

For retrofit bolting to concrete walls or for screwing onto steel housings. Used for the gastight and watertight connection of system seals for cables and cable ducts.



Cable entries

USP

- with integrated spirit level
- Tested solution for use with pre-applied waterproofing membrane

Scope of delivery

- 1 piece surface seal, 6 mm thick
- Fixing elements including sealing ring

Dimensions

- Length x width: 235 x 235 mm
- Recommended centre distance for core drills: 250 mm
- Core drills max. Ø: 150 mm
- Structure in front of wall including surface seal: 63 mm

Tightness

- gastight and watertight to 2.5 bar

Article code	Article number	GTIN
HSI150 DFK OB¹⁾	2118010022	4052487162555
HSI150 DFK	2118010020	4052487156264

¹⁾ without fastening elements

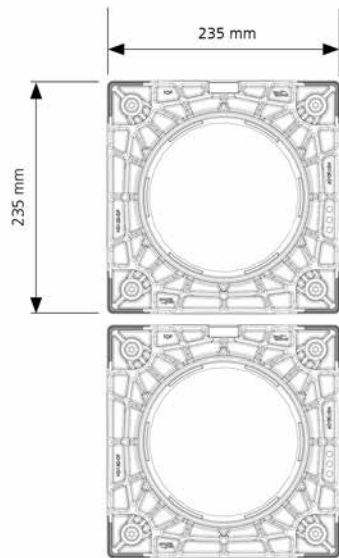

Multiple arrangement HSI150 DFK

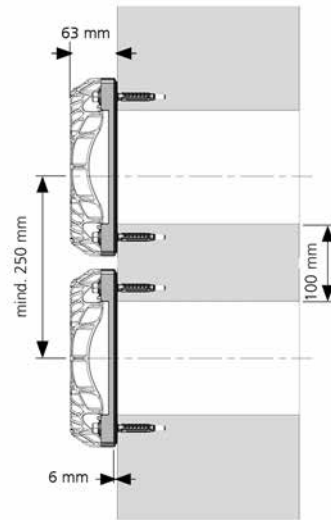

spacing dimensions



HSI150 DFK polymer flange with blind cover HSI150 DT

Accessories

Figure	Item	Article code	Article number	GTIN
	Sealant	Hybrid 7057Z	3030537533	4052487248617

Closing cover

for empty wall inserts and polymer flanges

HSI150 DT

For pressure-tight sealing of wall inserts that are not in use and polymer flange of the HSI150 system.



Cable entries

USP

- transparent closing cover with TPE seal
- makes the water accumulation in the connected cable duct system visible
- defined breaking point for connection of a drain valve

Scope of delivery

- 1 piece of lubricant stick

Tightness

- gastight and watertight



Item	Article code	Article number	GTIN
Closing cover	HSI150 DT	2126010172	4052487193566

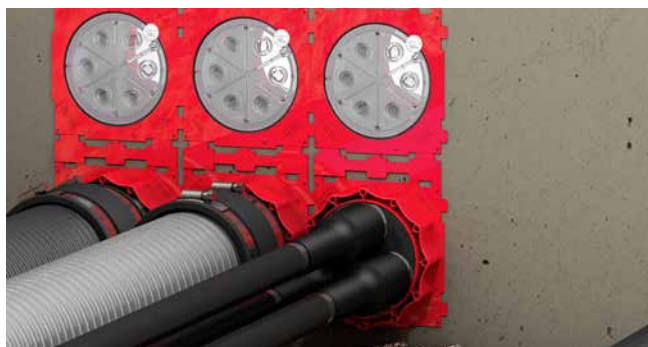

System cover

Cable seal with heat shrink technology

HSI150 D WS

For use in wall insert and plastic flange HSI150. The thermal sleeves offer a wide range of applications and are heat-shrunk onto the cables using the system cover. Unused system cover sockets can be sealed with blind plugs.



USP

- mechanical fixing (bayonet) and sealing (tension nut) act independently
- Bayonet system with backstop and counter screw connection (prevents self-opening)



Scope of delivery

- Thermal sleeves
- Centring strap for HSI 150-D1/80 and HSI 150-D3/58



Tightness

- gastight and watertight to 2.5 bar



Figure	Socket diameter	Number of cables/medium	Area of application cable OD (mm)	Article code	Article number	GTIN
	80	1	25-78	HSI150 D1x80 WS	2101100010	4052487054966
	58	3	22-56	HSI150 D3x58 WS	3030300082	4052487054997
	33	7	12-31	HSI150 D7x33 WS	3030300083	4052487197632



centring tape in system cover plugs of HSI150 D3x58 WS



Accessories

Figure	Item	Article code	Article number	GTIN
	Finger sleeves in hot shrink-fit method	3FM 1x44-13 3x16-4,2	5170060010	4052487233408
		3FM 1x71-22 3x26-9	5170060001	4052487233415
		4FM 1x55-21 4x20-7	5170060040	4052487233392
		4FM 1x80-25 4x27-9	5170060041	4052487233385
	Replacement shrink-fit sleeves in hot shrink-fit method	WSM I150 2x43-12	5170030020	4052487232968
		WSM I200 2x75-22	5170030061	4052487233439
		WSM I200 2x92-25	5170030090	4052487233422
	Repair sleeves in hot shrink-fit method	WSMR I250 2x53-13	350030000	4052487010351
		WSMR I250 2x85-22	350040000	4052487010375
		WSMR I250 2x107-29	350070000	4052487010429

System cover

Cable seal with cold shrink technology



HSI150 D KS

For use in wall insert and plastic flange HSI150. The cold shrink sleeves offer a wide range of applications and are shrunk onto the cables by the system cover socket without tools. Unused system cover sockets can be sealed with blind plugs.

USP

- mechanical fixing (bayonet) and sealing (tension nut) act independently
- Bayonet system with backstop and counter screw connection (prevents self-opening)



Scope of delivery

- cold shrink sleeves
- Centring strap for HSI 150-D1/80-KS and HSI 150-D3/58-KS





Tightness

- gastight and watertight to 2.5 bar

Figure	Socket diameter	Number of cables/medium	Area of application cable OD (mm)	Article code	Article number	GTIN
	80	1	38-78	HSI150 D1x80 KS	2102100010	4052487055253
	58	3	32-56	HSI150 D3x58 KS	2102100041	4052487055277
	33	7	19-31	HSI150 D7x33 KS	2102100051	4052487055314



Accessories

Figure	Item	Article code	Article number	GTIN
	Hot-melt adhesive tape	Hatetherm	316010000	4052487006668
	Replacement shrink-fit sleeves in cold shrink-fit method	KSM I223 2x119-56	5170040004	4052487232982
		KSM I240 2x154-76	5170040006	4052487232999

System cover

Cable sealing with elastomer shrink technology

HSI150 SF3x58



For use in wall insert and plastic flange HSI150. The flexible and robust system cover offers a wide range of applications, tool-free installation and gentle sealing of the cables. Bonds and seals on all cable sheath materials and metal. Unused system cover sockets can be sealed with blind plugs.

USP

- ideal for installation in confined spaces and for cables inserted at an angle
- quick, tool-less installation

- installation within 5 minutes

Tightness

- gastight and watertight

Figure	Socket diameter	Number of cables/medium	Area of application cable OD (mm)	Article code	Article number	GTIN
	58	3	34 - 58	HSI150 SF3x58	3030510838	4052487243971

Split system cover

for retrofit sealing

HSI150 DG

For use in wall insert and polymer flange HSI150. Split design for sealing new installed cables or cables that have already been installed.



USP

- super segmented ring technology for individual adjustment to cable diameters on site
- Segments with diameter marking
- form-fit design of the press plates

Scope of delivery

- 1 piece split adapter ring
- Blind plug (for multiple cable entries)
- 1 piece cleaning cloth

- 1 piece of kniefe
- 1 piece of lubricant stick

Dimensions

- Sealing width: 40 mm
- Press plates with reinforcement ribs: 20 mm

Tightness

- gastight and watertight to 2.5 bar
- radon-proof



Figure	Openings	Area of application cable OD (mm)	Article code	Article number	GTIN
	1	36-70	HSI150 DG 1x36-70¹⁾	2102200020	4052487121064
	1	70-112	HSI150 DG 1x70-112¹⁾	2102200030	4052487121071
	3	24-54	HSI150 DG 3x24-54	2102200000	4052487055444
	6	10-36	HSI150 DG 6x10-36	2102200010	4052487055451

¹⁾ without blind plug for unoccupied openings



low-voltage cables sealed with HSI150 DG 6x10-36



various installation stages for HSI150 DG 3x24-54



HSI150 DG: abelling of segments with the application range

Accessories

Figure	Item	Article code	Article number	GTIN
	Universal Toolset	WKZ U	3030513585	4052487248471

SEGMENTO

system cover for holding segments



HSI150 S3

System cover for use in wall insert and plastic flange HSI150 For especially gentle sealing of cables. Holds three segments of your choice for sealing cables OD 5 - 31 mm.

USP

- bayonet system with backstop (prevents self-opening)

Scope of delivery

- 1 piece GMS lubricant

Tightness

- gastight and watertight to 0.5 bar

Item	Article code	Article number	GTIN
SEGMENTO	HSI150 S3	3030300088	4052487062046



HSI150 - wall inserts fitted with SEGMENTO sealing for control cables in a transformer house



sealing of cables for street lighting with SEGMENTO

SEGMENTO

Segments for installation in HSI150 S3 system cover



SEG

For especially gentle sealing of micropipes and control lines.

USP

- particularly flexible and gentle sealing with Technogel
- integrated torque control
- colour-coded segments for easy identification the application range

Scope of delivery

- Blind plugs



Tightness

- gastight and watertight to 0.5 bar

Figure	Openings	Suitable for medium pipe OD (mm)	Article code	Article number	GTIN
	2	20-31	SEG 2x31	3030300180	4052487215442
	3	20-26	SEG 3x26	3030300181	4052487215459
	6	15-21	SEG 6x21	3030300182	4052487215466
	8	5-15	SEG 8x15	3030300183	4052487215473



Accessories

Figure	Item	Article code	Article number	GTIN
	Torque screwdriver for SEGMENTO	DSD	5200010236	4052487233477
	Assignment template for SEGMENTO	BSS	2300320000	4052487062244
	Lubricant for SEGMENTO	GMS	5020050021	4052487238557

Customized press seal

for micro pipes and empty conduits

HRD150 b60 A2/EPDM

Customized press seal in a closed design for sealing micro pipes or empty conduits.



Scope of delivery

- 1 piece of lubricant stick

Dimensions

- Sealing width: 60 mm
- Press plates: 5 mm

- for core drillings/wall sleeves \varnothing : 150 mm

Tightness

- gastight and watertight to 2.5 bar
- radon-proof



Figure	Openings	Carrier pipe \varnothing_a (mm)	Article code	Article number	GTIN
	24	10	HRD150 24x10 b60 A2/EPDM	2703270012	4052487185318
	15	14	HRD150 15x14 b60 A2/EPDM	2703270013	4052487193795
	21	14	HRD150 21x14 b60 A2/EPDM	2703270014	4052487194150
	14	16	HRD150 14x16 b60 A2/EPDM	2703270011	4052487185301
	12	20	HRD150 12x20 b60 A2/EPDM	2703270010	4052487185295
	4	50	HRD150 4x50 b60 A2/EPDM	2703270009	4052487185288

without blind plug for unoccupied openings

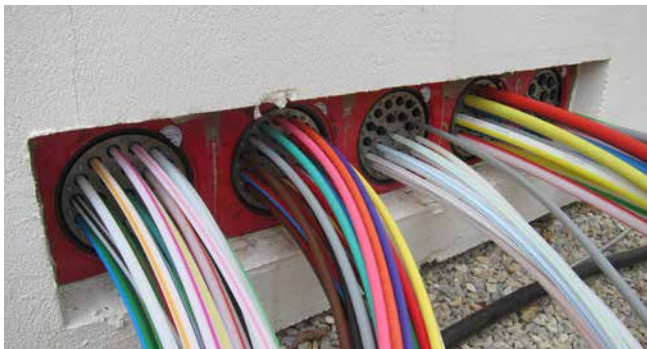

Accessories

Figure	Item	Width (mm)	Article code	Article number	GTIN
	Adapter ring for retrofit sealing	40	HRD150 SG/ARG	5060120155	4052487233330

System cover

with sleeve method for polymer spiral duct

KES MA150 D

For use with wall insert and polymer flange HSI150, and for connecting ducts. The seal is created using the sleeve method, clamping a rubber sleeve onto both the system cover and the polymer spiral duct with clamping straps.



Cable entries

USP

- mechanical fixing (bayonet) and sealing (tension nut) act independently
- Bayonet system with backstop and counter screw connection (prevents self-opening)

Scope of delivery

- 1 piece sleeve with clamping straps

Tightness

- gastight and watertight to 2.5 bar



Item	Article code	Article number	GTIN
System cover	KES MA150 D	2125810000	4052487058070



KES MA150 D und Spiralschlauch Hateflex14150



KES MA150 D and spiral hose Hateflex14150



System cover

with plug-in socket for smooth cable ducts



HSI150 D GSM

For use in wall insert and plastic flange HSI150. For connecting smooth cable ducts. The seal is created using the plug-in method.

USP

- mechanical fixing (bayonet) and sealing (tension nut) act independently
- Bayonet system with backstop and counter screw connection (prevents self-opening)

- push-fit connection with molded rubber part (OD 110 and 125 mm)

Tightness

- gastight and watertight to 0.5 bar



Pipe OD (mm)	Article code	Article number	GTIN
110	HSI150 D1x110 GSM	2101100105	4052487119443
125	HSI150 D1x125 GSM	2101100115	4052487119450



connection of a rigid cable duct DN 125 with HSI150 D 1x125 GSM

System cover

with sleeve method for smooth cable ducts

HSI150 MA GR

For use in wall insert and plastic flange HSI150. For connecting smooth cable ducts. The seal is created using the sleeve method, clamping a rubber sleeve onto both the system cover and the duct with clamping straps.



USP

- mechanical fixing (bayonet) and sealing (tension nut) act independently
- Bayonet system with backstop and counter screw connection (prevents self-opening)

Scope of delivery

- sleeve with clamping straps

Tightness

- gastight and watertight to 0.5 bar



Pipe OD	Carrier pipe Øa (mm)	Article code	Article number	GTIN
110	90-113	HSI150 MA110 GR	2126010110	4052487058346
125	110-125	HSI150 MA125 GR	2126010125	4052487058360
145	130-145	HSI150 MA145 GR	2126010140	4052487058377
168	150-172	HSI150 MA168 GR	2126010000	4052487058292

For corrugated pipe connections, clip rings CR are additionally required.
Additionally, 2 profile seals from the corrugated pipe manufacturer are required for each pipe connection.



System cover

with sleeve method for corrugated cable ducts



HSI150 MA WR

For use in wall insert and plastic flange HSI150. For connecting corrugated cable ducts. The seal is created with the sleeve method, with a rubber sleeve being clamped onto both the system cover and the duct with clamping straps.

USP

- mechanical fixing (bayonet) and sealing (tension nut) act independently
- Bayonet system with backstop and counter screw connection (prevents self-opening)

- patented clip ring technology

Scope of delivery

- sleeve with clamping straps
- including ring clips

Tightness

- gastight and watertight to 0.5 bar



Pipe OD (mm)	Manufacturer	Type	Article code	Article number	GTIN
110	Fränkische Rohrwerke	KABUFLEX	HSI150 MA110 WR	2126010113	4052487124980
125	Fränkische Rohrwerke	KABUFLEX	HSI150 MA125 WR	2126010007	4052487124973
168	Fränkische Rohrwerke	KABUFLEX	HSI150 MA168 WR	2126010001	4052487058308

When placing your order, please ensure that you specify the pipe manufacturer and type. Additionally, 2 profile seals from the corrugated pipe manufacturer are required for each pipe connection.



System cover

with cold shrink-fit method for corrugated cable ducts

HSI150 D KS WR

For use in wall insert and plastic flange HSI150. For connecting corrugated cable ducts. The cold shrink sleeves offer a wide range of applications and are shrunk onto the cables by the system cover socket without tools. Particularly gentle for thin-walled or temperature-sensitive pipes.



Cable entries

USP

- mechanical fixing (bayonet) and sealing (tension nut) act independently
- Bayonet system with backstop and counter screw connection (prevents self-opening)

Scope of delivery

- includes cold shrink tubing

Tightness

- gastight and watertight to 0.5 bar



Pipe OD (mm)	Article code	Article number	GTIN
110	HSI150 D1x110 KS WR	2102100060	4052487055338
125	HSI150 D1x125 KS WR	2102100070	4052487055352



connection of corrugated pipes with cold shrink sleeves HSI150 D1x110 KS WR



Cement-coated wall sleeve with sleeve

floor entry for Hateflex spiral duct



KES MA150 ZVR150/500

For use in waterproof concrete. The Hateflex 14150 spiral duct can be connected using a sleeve. The seal with the cables is created with a press seal that is not included in the scope of delivery.

USP

- special coating creates a watertight bond with the concrete
- the cement coated pipe can be cut to size, either straight or at an angle, once the floor has been finished

- 1 piece sleeve with clamping straps

Dimensions

- Wall sleeve ID: 150 mm
- Length (excluding sleeve): 500 mm

Tightness

- gastight and watertight

Scope of delivery

- 1 piece of closing cover

Item	Article code	Article number	GTIN
Cement-coated wall sleeve with sleeve	KES MA150 ZVR150/500	2125502000	4052487139991



Accessories

Figure	Item	Article code	Article number	GTIN
	Installation fixture for KES-M....-ZVR.../500	KES FUBO-FIX AV	1900500165	4052487165693
	Fastening bracket suitable for KES150 MA ZVR150/500 OD 160	KES150 FUBO-FIX BB160	1900500167	4052487165716

Wall insert

for HSI150 system seals

HSI150 1x1 KVB150

Wall insert for connecting to Hateflex spiral duct 14150. Optional for setting in concrete or for earth-side termination. Additional HSI150 system seals can be used to seal from the wall insert at the end of the duct onto the cables.



Cable entries

USP

- injection molded 3-ribbed seal for pressure-tight seal to the concrete

- 1 piece pressure-tight closing cover

Tightness

- gastight and watertight to 2.5 bar

Scope of delivery

- 1 piece sleeve with clamping straps

Item	Article code	Article number	GTIN
Wall insert	HSI150 1x1 KVB150	2125811000	4052487058087



Polymer spiral duct

for cable duct system



Hateflex14150

Flexible and very rugged duct A pressure-tight cable duct system can be created with the matching connection components.

USP

- flexible polymer spiral duct (peak compressive strength 450 N DIN EN 61386-24)
- A pressure-tight cable duct system (for up to 2.5 bar external pressure) can be created using the matching connection components.

Scope of delivery

- Coils in lengths of 25 m (special lengths are available in 0.5 m sections)
- closing cover included

Dimensions

- ID: 151 mm ± 1 mm
- OD: 166 mm ± 1 mm

Tightness

- gastight and watertight to 2.5 bar

Length (m)	Article code	Article number	GTIN
2.0	Hateflex14150/2000	3030589945	4052487247832
3.0	Hateflex14150/3000	3030589745	4052487247856
4.0	Hateflex14150/4000	3030589760	4052487247863
5.0	Hateflex14150/5000	3030589762	4052487247870
6.0	Hateflex14150/6000	3030589763	4052487247887
8.0	Hateflex14150/8000	3030589765	4052487247894
10.0	Hateflex14150/10000	3030589819	4052487247795
12.0	Hateflex14150/12000	3030589938	4052487247801
15.0	Hateflex14150/15000	3030589939	4052487247818
20.0	Hateflex14150/20000	3030589942	4052487247825
25.0	Hateflex14150/25000	3030589947	4052487247849

Other lengths on request



Accessories

Figure	Item	Article code	Article number	GTIN
	Spacer for the spiral duct 150	KES150 1x2 AH PP	3030361164	4052487233347

Connection sleeve

for extending the spiral duct

KES150 MA150-172/150-172

Connection sleeve for duct extension or duct connection for the Hateflex spiral duct 14150.



Cable entries

Scope of delivery

- 1 piece sleeve with clamping straps

Tightness

- gastight and watertight to 2.5 bar

Item	Article code	Article number	GTIN
Connection sleeve	KES150 MA150-172/150-172	2128020000	4052487058407



Pipe connection sleeve

for connecting smooth cable ducts

KES150 MA160-172/140-163

Connects Hateflex spiral duct 14150 to smooth cable ducts OD 160 mm.



Scope of delivery

- Clamping straps

Tightness

- gastight and watertight to 2.5 bar

Item	Article code	Article number	GTIN
Pipe connection sleeve	KES150 MA160-172/140-163	2125812000	4052487058100



Pipe connection sleeve

for connecting smooth cable ducts

KES150 MA160-172/140-163 AR111

Connects Hateflex spiral duct 14150 to smooth cable ducts OD 110 mm.



Scope of delivery

- Clamping straps
- 1 piece adapter ring Ø160 mm / Ø111 mm

Tightness

- gastight and watertight to 2.5 bar

Item	Article code	Article number	GTIN
Pipe connection sleeve	KES150 MA160-172/140-163 AR111	2125814000	4052487058131

Pipe connection sleeve

for connecting smooth cable ducts

KES150 MA160-172/140-163 AR126

Connects Hateflex spiral duct 14150 to smooth cable ducts OD 125 mm.



Scope of delivery

- Clamping straps
- 1 piece adapter ring Ø160 mm / Ø125 mm

Tightness

- gastight and watertight to 2.5 bar

Item	Article code	Article number	GTIN
Pipe connection sleeve	KES150 MA160-172/140-163 AR126	2125813000	4052487058124

Connection set for cable duct system with core drill holes/wall sleeve

for retrofit installation

KES150 MA KB SET

For connecting the Hateflex spiral duct 14150 to core drills or wall sleeves. The pipe socket is connected to the duct with a sleeve. Sealing is done with the two press seals (included in scope of delivery).



Scope of delivery

- 1 piece pipe including sleeve with clamping straps
- 2 pieces of press seals HSD 200/159

- Pipe socket OD: 150 mm
- Pipe socket length: 500 mm

Tightness

- gastight and watertight to 2.5 bar

Dimensions

- Pipe socket OD: 160 mm

Item	Article code	Article number	GTIN
Connection set for cable duct system with core drill holes/wall sleeve	KES150 MA KB SET¹⁾	2125818500	4052487140409

¹⁾ Other variants available, see www.hauff-technik.com

Duct connection

for connecting to core drill or wall sleeve



KES150 MA160-172/140-163 SET

For connecting the Hateflex spiral duct 14150 to core drills or wall sleeves and for forming a pressure-tight cable duct system (2.5 bar external pressure). The pipe socket is connected to the duct with a sleeve. Sealing within the wall is done by an additional press seal (not included in scope of delivery)

USP

- Duct connection to form a pressure-tight cable duct system (2.5 bar external pressure)

Scope of delivery

- 1 piece pipe including sleeve with clamping straps

Dimensions

- Pipe socket OD: 160 mm
- Protruding pipe socket length: approx. 440 mm

Tightness

- gastight and watertight to 2.5 bar

Article code	Article number	GTIN
KES150 MA160-172/140-163 SET	2125818000	4052487058278



Sealing set interchangeable insert

for cable sealing at the end of the duct



Cable entries

KES150 MA WE160 SG SET

Sealing set with sleeve including split interchangeable insert with segment ring technology for sealing cables with rubber seal at the end of Hateflex spiral duct 14150.

Scope of delivery

- Blind plugs
- Sleeve with clamping straps



- Interchangeable insert: OD 100 mm
- Maximum configuration: according to variant table

Dimensions

- Interchangeable insert: OD 160 mm

Tightness

- gastight and watertight to 0.5 bar

Figure	Number of cables/medium	Area of application cable OD (mm)	Article code	Article number	GTIN
	1	48-83	KES150 MA WE160 SG 1x48-83 SET	2125817103	4052487164764
	3	22-58	KES150 MA WE160 SG 3x22-58 SET	2125817102	4052487164757
	6	8-36	KES150 MA WE160 SG 6x8-36 SET	2125817101	4052487164740

Other variants available, see www.hauff-technik.com



sealing in soil at the end of spiral hose Hateflex14150 with the sealing set KES150 MA WE 160 SG 3x22-58 SET



pressure-tight connection of spiral duct Hateflex14150 to wall insert HSI150 and end stop for the cable duct



Sleeve

for cable sealing at the end of the duct

KES150 MA160-172/140-163 WE

For installation at the end of the Hateflex spiral duct 14150. Cables can be sealed within the sleeve by using the interchangeable insert WE160 z/d The entire cross-section of the duct is available when the cables are being laid.



Cable entries

Scope of delivery

- 1 piece sleeve with clamping straps

Tightness

- gastight and watertight to 2.5 bar

Item	Article code	Article number	GTIN
Sleeve	KES150 MA160-172/140-163 WE	2125817100	4052487120937



Split interchangeable insert with segment ring technology

for cable sealing at the end of the duct



WE160 SG

For installation within the KES150 MA WE sleeve to seal cables at the end of the Hateflex spiral duct 14150

Scope of delivery

- Blind plugs

Dimensions

- OD: 160 mm





- Sealing width: 60 mm
- Maximum configuration: according to variant table

Tightness

- gastight and watertight to 2.5 bar



Figure	Number of cables/medium	Article code	Article number	GTIN
	1	WE160 SG 1x48-83	825817116	4052487164719
	3	WE160 SG 3x22-58	825817115	4052487164702
	6	WE160 SG 6x8-36	825817114	4052487164696

General accessories



Figure	Item	Bestellbezeichnung	Article number	GTIN
	Cable cleaner	KR706	3030609811	4052487248716
	Flexible socket wrench	SLS 6G	5200010040	4052487233491
		SLS 6GD¹⁾	5200010041	4052487233484
	Lubricant	GML	5020050010	4052487238564

¹⁾ for buildings with perimeter insulation

Wall inserts and polymer flange

Figure	Item	Bestellbezeichnung	Article number	GTIN
	Pressure discharge element discharge valve for HSI150 DT closing cover	HSI150 DAE	2126010170	4052487193504
	Hose extension for pressure discharge element	HSI150 DAE SV	2126010171	4052487193559
	Spacer	HSI AH40 SET2	3030300093	4052487220156

System covers with shrink-fit sleeve

Figure	Item	Bestellbezeichnung	Article number	GTIN
	Blind plug For system cover	VS32/34	3030300266	4052487216319
		VS58/60	3030300267	4052487216326
	Set of centering tape	Zentrierband EPDM50	5060120250	4052487233323

Cable duct systems

Figure	Item	Bestellbezeichnung	VPE	Article number	GTIN
	Installation fixture for KES-M...-ZVR.../500	KES FUBO-FIX AV	1	1900500165	4052487165693
	Fastening bracket suitable for KES150 MA ZVR150/500 OD 160	KES150 FUBO-FIX BB160	1	1900500167	4052487165716
	Connection sleeve for extending the spiral duct	KES150 MA150-172/150-172	1	2128020000	4052487058407
	Pipe connection sleeve for connecting smooth cable ducts	KES150 MA160-172/140-163	1	2125812000	4052487058100
	Ring clips for corrugated cable ducts and pipes	CR110 A2	1	1630500110	4052487134491
		CR125 A2	1	1630500125	4052487134514
		CR160 A2	1	1630500160	4052487134538
	Duct connection for connecting to core drill or wall sleeve	KES150 MA160-172/140-163 SET	1	2125818000	4052487058278
	Spacer for the spiral duct 150	KES150 1x2 AH PP	1	3030361164	4052487233347
	Universal Toolset	WKZ U	1	3030513585	4052487248471

Single wall insert

for setting in concrete

HSI90 K/X

For the one-sided gastight and watertight connection of system covers for cables or cable ducts, for a high level of flexibility in future use.

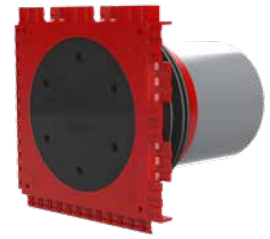

USP

- injection molded 3-ribbed seal for pressure-tight seal to the concrete

Scope of delivery

- 1 piece pressure-tight closing cover

Dimensions

- Frame dimensions: 145x 145 mm (per wall insert)
- Centre distance: 135 mm
- Minimum wall thickness: 70 mm



Tightness

- gastight and watertight to 2.0 bar
- radon-proof

Wall thickness (mm)	Article code	Article number	GTIN
100	HSI90 1x1 K/100	3030303447	4052487223263
120	HSI90 1x1 K/120	3030303489	4052487211055
150	HSI90 1x1 K/150	3030303367	4052487222945
200	HSI90 1x1 K/200	3030303449	4052487223270
250	HSI90 1x1 K/250	3030303453	4052487223294

Price for wall thickness up to 500 mm. Price on request for wall thickness > 500 mm.
The article numbers, article codes and GTINs for the exact wall thicknesses can be found at: www.hauff-technik.com

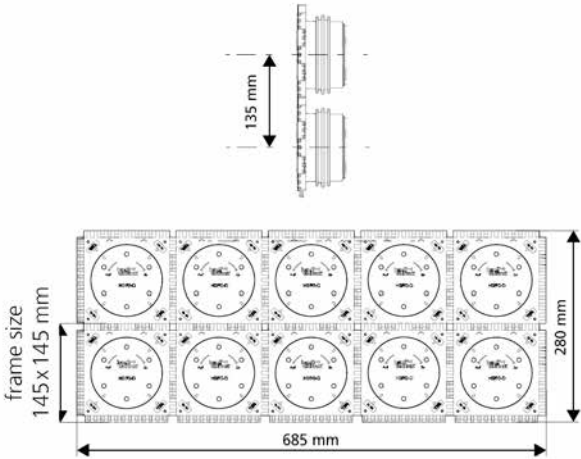

HSI90 mounting frame manufactured in a two-component injection moulding process

Slanted single wall insert

for setting in concrete

HSI90 1xZ K S_°/X



For slanted cable entries from any direction and an optimised bending radius when inserting and sealing cables or connecting cable ducts.

USP

- injection molded 3-ribbed seal for pressure-tight seal to the concrete

Scope of delivery

- 1 piece polystyrene wedge
- Mounting frame

- 1 piece pressure-tight closing cover

Dimensions

- Centre distance: 135 mm

Tightness

- gastight and watertight to 2.0 bar
- radon-proof



Installation angle	Minimum wall thickness (mm)	Article code
30 °	190	HSI90 1xZ K S30°/X¹⁾
45 °	200	HSI90 1xZ K S45°/X¹⁾

¹⁾ Article number and GTIN on request

Z = number of columns (1-6), X = wall thickness (mm, 180-230)

The minimum concrete cover of 200 mm in accordance with the waterproof concrete guideline (information sheet H10) is only reached from a wall thickness of 300 mm (S45° - 350 mm) with the HSI90 K S30° slanted wall insert.

Single wall insert with foldable rubber sleeve

for setting in concrete and connecting cable ducts



HSI90 KMA

For the direct connection of cable ducts (exterior) and for connecting system seals for cables (interior).

USP

- thanks to the folding sleeve technique, no additional pipe connection components are needed
- elastic and firmly supported connection due to increased insertion depth, even with deflection of the cable duct
- Installation of cable seals on the inside possible

Scope of delivery

- 1 piece pressure-tight closing cover
- 1 piece blind cover
- 1 piece of clamping strap



Dimensions

- Frame dimensions: 145x 145 mm (per wall insert)

Tightness

- gastight and watertight
- radon-proof

Wall thickness (mm)	Pipe OD (mm)	Article code	Article number
200	63	HSI90 1x1 KMA94/63/200 CH	3030576760
250		HSI90 1x1 KMA94/63/250 CH	3030576761
300		HSI90 1x1 KMA94/63/300 CH	3030576767
120	72	HSI90 1x1 KMA94/72/120 CH	3030576689
140		HSI90 1x1 KMA94/72/140 CH	3030576690
150		HSI90 1x1 KMA94/72/150 CH	3030576691
200		HSI90 1x1 KMA94/72/200 CH	3030576692
250		HSI90 1x1 KMA94/72/250 CH	3030576693
300		HSI90 1x1 KMA94/72/300 CH	3030576732
120	92	HSI90 1x1 KMA94/120 CH	3030488698
140		HSI90 1x1 KMA94/140 CH	3030541050
150		HSI90 1x1 KMA94/150 CH	3030534049
200		HSI90 1x1 KMA94/200 CH	3030541058
250		HSI90 1x1 KMA94/250 CH	3030541060
300		HSI90 1x1 KMA94/300 CH	3030541061

Double wall insert

for setting in concrete

HSI90 K2/X

For gastight and watertight connection of system covers for sealing of cables and cable ducts on both sides and maximum flexibility in future use.

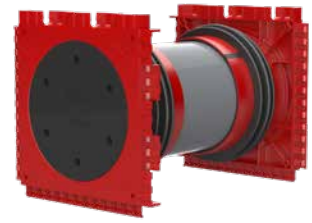

USP

- injection molded 3-ribbed seal for pressure-tight seal to the concrete

Scope of delivery

- 2 pieces of pressure-tight closing covers

Dimensions

- Frame dimensions: 145x 145 mm (per wall insert)
- Centre distance: 135 mm
- Minimum wall thickness: 100 mm



Tightness

- gastight and watertight to 2.0 bar
- radon-proof

Wall thickness (mm)	Article code	Article number	GTIN
120	HSI90 1x1 K2/120	3030309799	4052487244039
140	HSI90 1x1 K2/140	3030303704	4052487244053
200	HSI90 1x1 K2/200	3030440556	4052487242042
250	HSI90 1x1 K2/250	3030440663	4052487242080
300	HSI90 1x1 K2/300	3030440611	4052487242059

Price for wall thickness up to 500 mm. Price on request for wall thickness > 500 mm.
The article numbers, article codes and GTINs for the exact wall thicknesses can be found at: www.hauff-technik.com

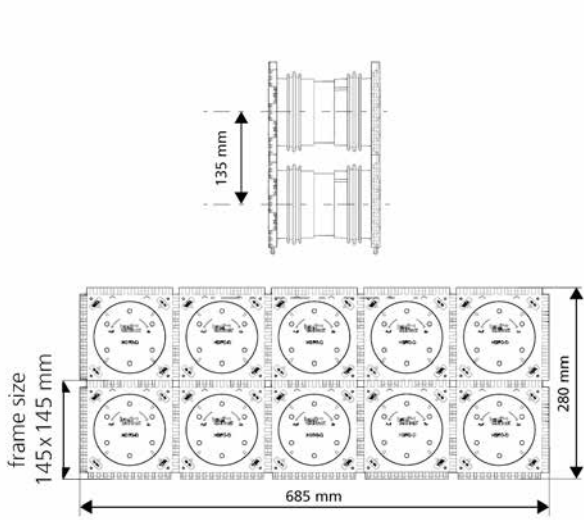

example 2x5 block for 200 mm wall thickness: article code: HSI90 2x5 K2/250



double wall insert HSI90 as block used in formwork

Double slanted wall insert

for setting in concrete

HSI90 1xZ K2 S_°/X



For slanted cable entries from any direction and an optimised bending radius when inserting and sealing cables or connecting cable ducts.

USP

- injection molded 3-ribbed seal for pressure-tight seal to the concrete

Scope of delivery

- 2 pieces of polystyrene wedges
- Mounting frame

- 2 pieces of pressure-tight closing covers

Dimensions

- Centre distance: 135 mm

Tightness

- gastight and watertight to 2.0 bar
- radon-proof



Installation angle	Minimum wall thickness (mm)	Article code
30 °	200	HSI90 1xZ K2 S30°/X ¹⁾
45 °	210	HSI90 1xZ K2 S45°/X ¹⁾

¹⁾ Article number and GTIN on request

Z = number of columns (1-6), X = wall thickness (mm, 180-230)

The minimum concrete cover of 200 mm in accordance with the waterproof concrete guideline (information sheet H10) is only reached from a wall thickness of 298 mm (S45° - 335 mm, S60° - 360mm) with the HSI90 K2 S30° slanted wall insert.

Polymer flange

for retrofit installation

HSI90 DFK

For retrofit bolting to concrete walls or for screwing onto steel housings. Used for the gastight and watertight connection of system seals for cables and cable ducts.



USP

- with integrated spirit level
- Tested solution for use with pre-applied waterproofing membrane

Scope of delivery

- Fixing elements including sealing ring
- 1 piece surface seal, 6 mm thick

Dimensions

- Length x width: 185 x 185 mm
- Recommended centre distance for core drills: 200 mm
- Core drills max. Ø: 100 mm
- Build-up in front of the wall including surface seal: 40 mm

Tightness

- gastight and watertight to 2.0 bar

Article code	Article number	GTIN
HSI90 DFK	3030466887	4052487240529
HSI90 DFK OB¹⁾	3030572403	4052487247313

¹⁾ without fastening elements

Accessories

Figure	Item	Article code	Article number	GTIN
	Sealant	Hybrid 7057Z	3030537533	4052487248617

Closing cover

for unused wall inserts or polymer flange

HSI90 D

For pressure-tight sealing of unused wall inserts and polymer flanges of the HSI90 system.



Tightness

- gastight and watertight to 2.0 bar

Item	Article code	Article number	GTIN
Closing cover	HSI90 D	2205010000	4052487060851

System cover

Cable seal with heat shrink technology



Cable entries

HSI90 D WS

For use in wall insert and polymer flange HSI90. The thermal sleeves offer a wide range of applications and are heat-shrunk onto the cables using the system cover. Unused system cover sockets can be sealed with blind plugs.

USP



- mechanical fixing (bayonet) and sealing (tension nut) act independently
- Bayonet system with backstop and counter screw connection (prevents self-opening)

Scope of delivery

- Thermal sleeves
- Centring strap for HSI 90-D1/75

Tightness

- gastight and watertight to 2.0 bar

Figure	Socket diameter	Number of cables/medium	Area of application cable OD (mm)	Article code	Article number	GTIN
	75	1	25-72	HSI90 D1x75 WS	3030300089	4052487060936
	32	3	12-30	HSI90 D3x32 WS	3030300090	4052487060899
	20	6	8-18	HSI90 D6x20 WS	3030300091	4052487060912



station entry: low-voltage cable sealed HSI90 D1x75 WS and HSI90 D3x32 WS

Accessories

Figure	Item	Article code	Article number	GTIN
	Replacement shrink-fit sleeves in hot shrink-fit method	WSM I150 2x25-8	5170030005	4052487233446
	Repair sleeves in hot shrink-fit method	WSMR I250 2x85-22	350040000	4052487010375
	Finger sleeves in hot shrink-fit method	3FM 1x44-13 3x16-4,2	5170060010	4052487233408
		4FM 1x55-21 4x20-7	5170060040	4052487233392
	Repair sleeves in hot shrink-fit method	WSMR I250 2x53-13	350030000	4052487010351
	Replacement shrink-fit sleeves in hot shrink-fit method	WSM I150 2x43-12	5170030020	4052487232968
	Repair sleeves in hot shrink-fit method	WSMR I250 2x34-10	350010000	4052487010337
	Replacement shrink-fit sleeves in hot shrink-fit method	WSM I200 2x92-25	5170030090	4052487233422

System cover

Cable seal with cold shrink technology



HSI90 D KS

For use in wall insert and polymer flange HSI90. The cold shrink sleeves offer a wide range of applications and are shrunk onto the cables by the system cover socket without tools. Unused system cover sockets can be sealed with blind plugs.

USP



- mechanical fixing (bayonet) and sealing (tension nut) act independently
- Bayonet system with backstop and counter screw connection (prevents self-opening)

Scope of delivery



- cold shrink sleeves
- Centring strap for HSI 90-D1/75-KS

Tightness

- gastight and watertight to 2.0 bar

Figure	Socket diameter	Number of cables/medium	Area of application cable OD (mm)	Article code	Article number	GTIN
	75	1	38-72	HSI90 D1x75 KS	2206040005	4052487130547
	32	3	19-30	HSI90 D3x32 KS	2206050060	4052487061124
	20	6	14-18	HSI90 D6x20 KS	2206050070	4052487061131

Accessories

Figure	Item	Article code	Article number	GTIN
	Hot-melt adhesive tape	Hatetherm	316010000	4052487006668
	Replacement shrink-fit sleeves in cold shrink-fit method	KSM I235 2x98,3-24,4	5170040001	4052487232975

System cover

for connection to the wall insert HSI90



KES MA90 D

For connecting the Hateflex spiral duct 14090 to the wall insert or polymer flange HSI90.

USP

- mechanical fixing (bayonet) and sealing (tension nut) act independently
- Bayonet system with backstop and counter screw connection (prevents self-opening)

Scope of delivery

- 1 piece sleeve with clamping straps

Tightness

- gastight and watertight to 2.5 bar

Item	Article code	Article number	GTIN
System cover	KES MA90 D	2225810000	4052487061377

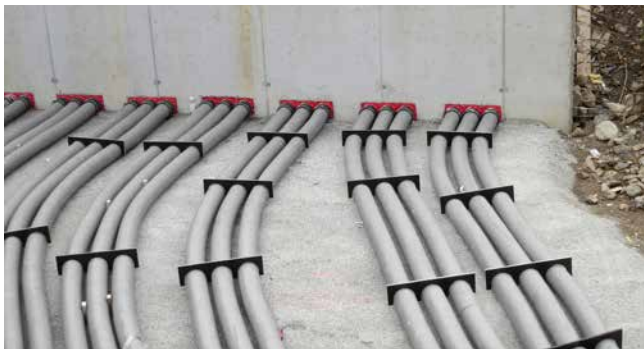

KES MA90 D and spiral hose Hateflex14090



KES MA90 D - connection to the HSI90 wall insert



System cover

with sleeve method for smooth cable ducts



HSI90 MA GR

For use in wall insert and polymer flange HSI90. For connecting smooth cable ducts. The seal is created using the sleeve method, clamping a rubber sleeve onto both the system cover and the duct with clamping straps.

USP

- mechanical fixing (bayonet) and sealing (tension nut) act independently
- Bayonet system with backstop and counter screw connection (prevents self-opening)

Scope of delivery

- 1 piece sleeve with clamping straps

Tightness

- gastight and watertight to 0.5 bar

Pipe OD (mm)	Article code	Article number	GTIN
75	HSI90 MA75 GR	2206040015	4052487129145
90	HSI90 MA90 GR	2206040018	4052487060981
110	HSI90 MA110 GR	2206040020	4052487060998

For corrugated pipe connections, clip rings CR are additionally required.
Additionally, 2 profile seals from the corrugated pipe manufacturer are required for each pipe connection.

System cover

with cold shrink-fit method for corrugated cable ducts



HSI90 D1x75 KS WR

For use in wall insert and polymer flange HSI90. For connecting corrugated cable ducts. The cold shrink sleeves offer a wide range of applications and are shrunk onto the cables by the system cover socket without tools. Particularly gentle for thin-walled or temperature-sensitive pipes.

USP

- mechanical fixing (bayonet) and sealing (tension nut) act independently
- Bayonet system with backstop and counter screw connection (prevents self-opening)

Scope of delivery

- 1 piece shrink tubing

Dimensions

- For pipe diameter: OD: 75 mm

Tightness

- gastight and watertight to 0.5 bar

Pipe OD (mm)	Article code	Article number	GTIN
75	HSI90 D1x75 KS WR	2206040001	4052487060943



connection of corrugated ducts HSI90 D1x75 KS WR

Cement-coated wall sleeve with sleeve

floor entry for Hateflex spiral duct

KES MA90 ZVR100/500

For use in waterproof concrete. The Hateflex 14090 spiral duct can be connected by using a sleeve. The seal with the cables is created with a press seal that is not included in the scope of delivery.



Cable entries

USP

- special coating creates a watertight bond with the concrete
- the cement coated pipe can be cut to size, either straight or at an angle, once the floor has been finished

- 1 piece sleeve with clamping straps

Dimensions

- Wall sleeve ID: 100 mm
- Length (excluding sleeve): 500 mm

Tightness

- gastight and watertight

Scope of delivery

- 1 piece of closing cover

Item	Article code	Article number	GTIN
Cement-coated wall sleeve with sleeve	KES MA90 ZVR100/500	2125502003	4052487164894



side by side arrangement 2x KES90 MA ZVR100/500 on the installation fixture KES FUBO-FIX AV

Accessories

Figure	Item	Article code	Article number	GTIN
	Installation fixture for KES-M...-ZVR.../500	KES FUBO-FIX AV	1900500165	4052487165693
	Fastening bracket suitable for KES90 MA ZVR150/500 OD 110	KES90/110 FUBO-FIX BB110	1900500166	4052487165709

Wall insert

For the installation of HSI90 system seals

HSI90 1x1 KVB90

Wall insert for connecting to Hateflex spiral duct 14090. Optional for setting in concrete or for earth-side termination. Additional HSI90 system seals can be used to seal from the wall insert at the end of the duct onto the cables.



USP

- injection molded 3-ribbed seal for pressure-tight seal to the concrete

Scope of delivery

- 1 piece sleeve with clamping straps

- 1 piece pressure-tight closing cover

Tightness

- gastight and watertight to 2.5 bar

Pipe OD (mm)	Article code	Article number	GTIN
102	HSI90 1x1 KVB90	2225811000	4052487061384



Polymer spiral duct

for cable duct system



Hateflex14090

Flexible and very rugged duct A pressure-tight cable duct system can be created with the matching connection components.

USP

- flexible polymer spiral duct (peak compressive strength 450 N DIN EN 61386-24)
- A pressure-tight cable duct system (for up to 2.5 bar external pressure) can be created using the matching connection components.

Scope of delivery

- Coils in lengths of 25 m (special lengths are available in 0.5 m sections)
- closing cover included

Dimensions

- ID: 91 mm ± 1 mm
- OD: 104 mm ± 1 mm

Tightness

- gastight and watertight to 2.5 bar

Length (m)	Article code	Article number	GTIN
1.5	Hateflex14090/1500	3030590137	4052487247610
2.0	Hateflex14090/2000	3030590139	4052487247634
3.0	Hateflex14090/3000	3030590121	4052487247658
6.0	Hateflex14090/6000	3030590122	4052487247665
8.0	Hateflex14090/8000	3030590124	4052487247672
10.0	Hateflex14090/10000	3030590164	4052487247580
12.0	Hateflex14090/12000	3030590166	4052487247597
15.0	Hateflex14090/15000	3030590136	4052487247603
20.0	Hateflex14090/20000	3030590138	4052487247627
25.0	Hateflex14090/25000	3030590140	4052487247641

Other lengths on request



Accessories

Figure	Item	Article code	Article number	GTIN
	Spacer for the Hateflex spiral hose 14090	KES90 2x4 AH	5010060046	4052487233699

Connection sleeve

for extending the spiral duct

KES90 MA90-102/90-102

Connection sleeve for duct extension or duct connection onto Hateflex spiral duct 14090.



Scope of delivery

- 1 piece sleeve with clamping straps

Tightness

- gastight and watertight to 2.5 bar

Item	Article code	Article number	GTIN
Connection sleeve	KES90 MA90-102/90-102	2209060100	4052487061186



Pipe connection sleeve

for connecting smooth cable ducts

KES90 MA70-90/90-110

Used to connect Hateflex14090 spiral duct to smooth cable ducts Øa 75 mm or 90 mm.



Scope of delivery

- Clamping straps

Tightness

- gastight and watertight to 2.5 bar

Item	Article code	Article number	GTIN
Pipe connection sleeve	KES90 MA70-90/90-110	2225814000	4052487061414



Pipe connection sleeve

for connecting smooth cable ducts

KES110 MA110-125/90-113

The KES110 MA110-125/90-113 is used to connect Hateflex14110 spiral duct to smooth cable ducts with OD 110 mm.



Cable entries

USP

- gas-tight and watertight rubber sleeve technology

- 2 pieces of clamping straps

Tightness

- gastight and watertight to 2.5 bar

Scope of delivery

- 1 piece connection sleeve KES110 MA110-125/90-113

Article code	Article number	GTIN
KES110 MA110-125/90-113	825814000	4052487015806



Pipe connection

for connecting to core drill or wall sleeve



KES90 MA110-125/90-113 SET

For connecting the Hateflex spiral duct 14090 to core drills or wall sleeves. The pipe socket is connected to the duct with a sleeve. An additional press seal is required for sealing to the wall.

Scope of delivery

- 1 piece pipe including sleeve with clamping straps

- Protruding pipe socket length: approx. 440 mm

Tightness

- gastight and watertight to 2.5 bar

Dimensions

- Pipe socket OD: 90 mm

Figure	Number of cables/medium	Area of application cable OD (mm)	Article code	Article number	GTIN
	1	110-125	KES90 MA110-125/90-113 SET	2225818000	4052487061452
	1	90-113			



Connection set for cable duct system with core drill holes/wall sleeve

for retrofit installation



Cable entries

KES90 MA KB SET

For connecting the Hateflex spiral duct 14090 to core drills or wall sleeves. The pipe socket is connected to the duct with a sleeve. Sealing is done with the two press seals (included in scope of delivery).

Scope of delivery

- 1 piece pipe including sleeve with clamping straps
- 2 pieces of press seals HSD 150/110

- Pipe socket OD: 100 mm
- Pipe socket length: 500 mm

Tightness

- gastight and watertight to 2.5 bar

Dimensions

- Pipe socket OD: 110 mm

Item	Article code	Article number	GTIN
Connection set for cable duct system with core drill holes/wall sleeve	KES90 MA KB SET¹⁾	2125818504	4052487164900

¹⁾ Other variants available, see www.hauff-technik.com



Sealing set interchangeable insert

for cable sealing at the end of the duct

KES90 MA90-102/90-102 WE100 SG
1x18-65



Sealing set with sleeve KES-M 90-WE including split interchangeable insert with segment ring technology for sealing cables with a rubber seal technology at the end of Hateflex14090 spiral duct.

Scope of delivery

- Blind plugs
- Sleeve with clamping straps: KES-M 90-WE

- Interchangeable insert: OD 100 mm
- Cable Øa: 18 - 65 mm

Tightness

- gastight and watertight to 0.5 bar

Dimensions

- Sealing width interchangeable insert: 60 mm

Item	Article code	Article number	GTIN
Sealing set interchangeable insert	KES90 MA90-102/90-102 WE100 SG 1x18-65	2225817101	4052487164726



pressure-tight connection of spiral hose Hateflex14090 to wall insert HSI90 and end stop for the cable duct



sealing set KES90 MA WE100 SG 1x18-65 SET for cable sealing at end of cable duct

Sleeve

for cable sealing at the end of the duct

KES90 MA90-102/90-102 WE

For installation at the end of the Hateflex spiral duct 14090. In combination with the interchangeable insert WE 100-z/d, which is installed in the sleeve, cables can be sealed using rubber compression technology. The entire cross-section of the duct is available when the cables are being laid.



Scope of delivery

- 1 piece sleeve with clamping straps

Tightness

- gastight and watertight to 2.5 bar

Item	Article code	Article number	GTIN
Sleeve	KES90 MA90-102/90-102 WE	2225817100	4052487120951

Split interchangeable insert with segment ring technology

for cable sealing at the end of the duct

WE100 SG 1x18-65

For installation in the KES-M 90-WE sleeve and sealing of cables with rubber compression technology at the end of the Hateflex14090 spiral duct.

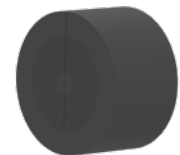

Scope of delivery

- Blind plugs

Dimensions

- OD: 100 mm



- Sealing width: 60 mm
- Application range cable diameter: 18 - 65 mm

Tightness

- gastight and watertight to 0.5 bar



Article code	Article number	GTIN
WE100 SG 1x18-65	825817112	4052487159166

General accessories

Figure	Item	Bestellbezeichnung	Article number	GTIN
	Cable cleaner	KR706	3030609811	4052487248716
	Flexible socket wrench	SLS 6G	5200010040	4052487233491
		SLS 6GD¹⁾	5200010041	4052487233484
	Lubricant	GML	5020050010	4052487238564

¹⁾ for buildings with perimeter insulation

System covers with shrink-fit sleeve

Figure	Item	Bestellbezeichnung	Article number	GTIN
	Blind plug For system cover	VS32/34	3030300266	4052487216319
		VS58/60	3030300267	4052487216326
	Set of centering tape	Zentrierband EPDM50	5060120250	4052487233323

Cable duct systems

Figure	Item	Bestellbezeichnung	VPE	Article number	GTIN
	Installation fixture for KES-M...-ZVR.../500	KES FUBO-FIX AV	1	1900500165	4052487165693
	Fastening bracket suitable for KES90 MA ZVR150/500 OD 110	KES90/110 FUBO-FIX BB110	1	1900500166	4052487165709
	Connection sleeve for extending the spiral duct	KES90 MA90-102/90-102	1	2209060100	4052487061186
		KES90 MA70-90/90-110	1	2225814000	4052487061414
	Pipe connection sleeve for connecting smooth cable ducts	KES110 MA110-125/90-113	1	825814000	4052487015806
	Ring clips for corrugated cable ducts and pipes	CR90 A2	1	1630500090	4052487134484
		CR110 A2	1	1630500110	4052487134491
	Pipe connection for connecting to core drill or wall sleeve	KES90 MA110-125/90-113 SET	1	2225818000	4052487061452
	Spacer for the Hateflex spiral hose 14090	KES90 2x4 AH	1	5010060046	4052487233699
	Universal Toolset	WKZ U	1	3030513585	4052487248471

02 Wall sleeves

Effective building protection starts long before construction begins - it starts in the planning of every wall opening. By considering cable and pipe penetrations, you lay the foundation for a secure, future-proof structure. Building entries are essential elements in protecting the building and ensuring long-lasting structural integrity.

As leading experts in innovative sealing technology, Hauff-Technik offers a complete range of wall sleeves engineered for reliability. Our products ensure dependable protection against the ingress of water and gas.



Whether connecting a waterproof membrane, preparing a new building or sealing an existing structure, Hauff-Technik delivers solutions for every requirement. With our portfolio of wall sleeves and sealing systems, we provide products for any wall entry – precise, resilient and ready for every challenge.

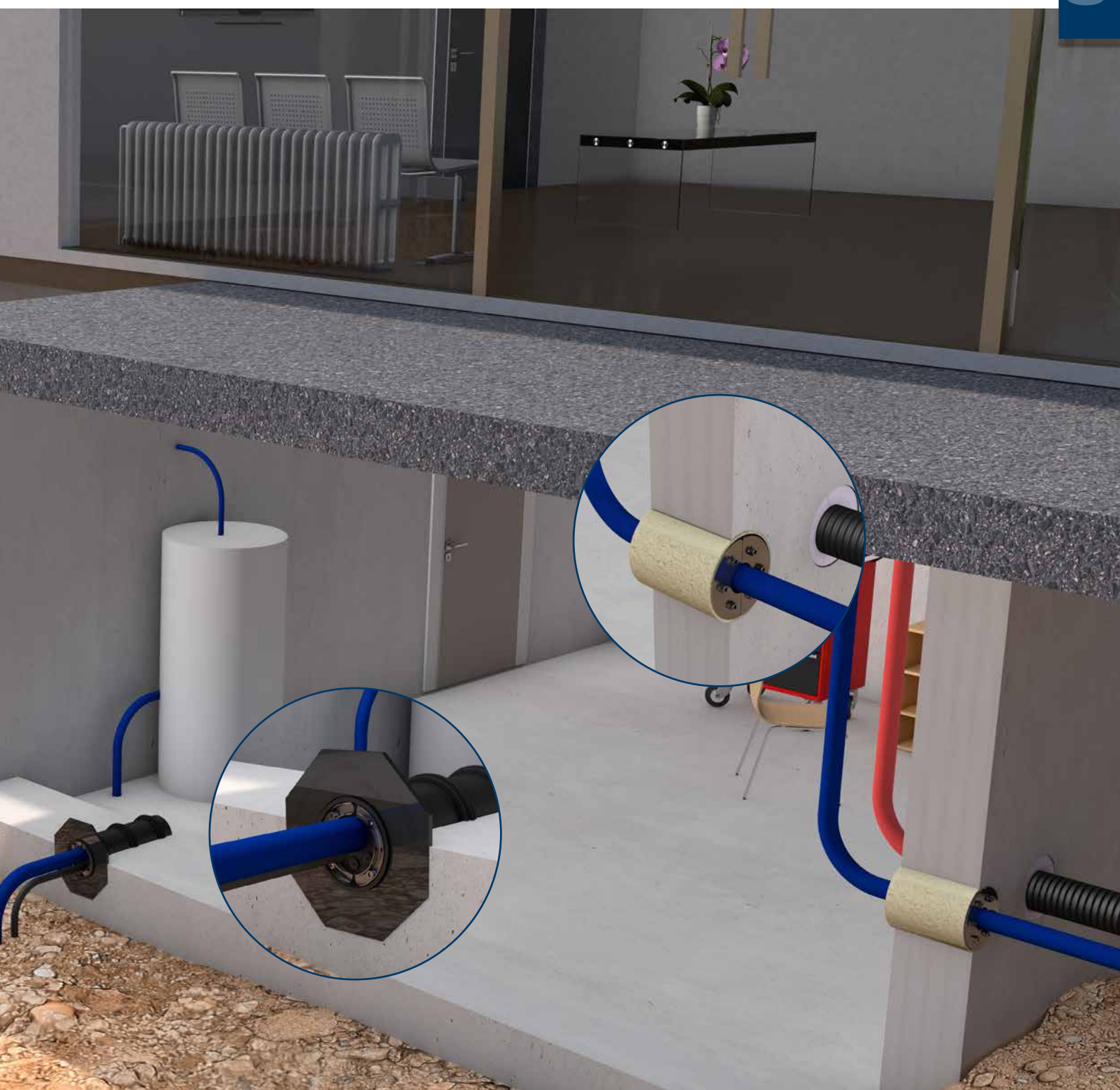

Cement-coated wall sleeve

with special coating

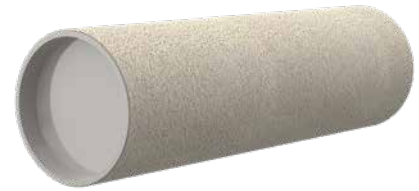

ZVR

For installation in waterproof concrete. Coating bonds homogeneously with the concrete.

USP

- special coating creates a watertight bond with the concrete
- watertight connection to the concrete along the entire surface of the wall sleeve, due to special coating
- closing cover included

Scope of delivery

- Wall sleeve with special counting

- 2 pieces of closing covers

Dimensions

- Pipe length ≤ 600 mm: fully coated wall sleeve
- Pipe length > 600 mm: partially coated wall sleeve

Tightness

- gastight and watertight



Wall sleeve ID (mm)	Wall sleeve OD (mm)	Wall thickness (mm)	Article code	Article number	GTIN
50	54	200	ZVR50/200 fc	1200050200	4052487201308
		400	ZVR50/400 fc	1200050400	4052487204897
80	95	200	ZVR80/200 fc	1200080200	4052487124195
		400	ZVR80/400 fc	1200080400	4052487124249
100	115	200	ZVR100/200 fc	1200100200	4052487124294
		400	ZVR100/400 fc	1200100400	4052487124348
125	142	200	ZVR125/200 fc	1200125200	4052487124393
		400	ZVR125/400 fc	1200125400	4052487124447
150	167	200	ZVR150/200 fc	1200150200	4052487124492
		400	ZVR150/400 fc	1200150400	4052487124546
200	219	200	ZVR200/200 fc	1200200200	4052487124591
		400	ZVR200/400 fc	1200200400	4052487124645
250	269	200	ZVR250/200 fc	1200250200	4052487124706
		400	ZVR250/400 fc	1200250400	4052487124751
300	321	200	ZVR300/200 fc	1200300200	4052487124812
		400	ZVR300/400 fc	1200300400	4052487124867

Standard lengths: 200, 240, 250, 300, 365, 400, 500 mm (other lengths on request)
 The article numbers, article codes and GTINs for the exact wall thicknesses can be found at: www.hauff-technik.com
 For lengths > 600 mm, the cement-coated wall sleeve is coated on each side by 250 mm.
 fc = fully coated, c = coated / partially coated on each side by 250mm



ZVR150 and ZVR200 set in concrete next to HSI150



ZVR200/300 fixed in formwork



ZVR150 und ZVR200 einbetoniert neben HSI150



Fibre cement wall sleeve

FZR

For setting in concrete or mortar. Outer grooves all round ensure a tight and force-fit bond with the wall.



Wall sleeve ID (mm)	Wall sleeve OD (mm)	Wall thickness (mm)	Article code	Article number
80	≤ 140	300	FZR80/300	1800080300
	≤ 140	500	FZR80/500	1800080500
100	≤ 160	300	FZR100/300	1800100300
	≤ 160	500	FZR100/500	1800100500
125	≤ 170	300	FZR125/300	1800125300
	≤ 170	500	FZR125/500	1800125500
150	≤ 205	300	FZR150/300	1800150300
	≤ 205	500	FZR150/500	1800150500
200	≤ 255	300	FZR200/300	1800200300
	≤ 255	500	FZR200/500	1800200500
250	≤ 305	300	FZR250/300	1800250300
	≤ 305	500	FZR250/500	1800250500
300	≤ 355	300	FZR300/300	1800300300
	≤ 355	500	FZR300/500	1800300500
350	≤ 405	300	FZR350/300	1800350300
	≤ 405	500	FZR350/500	1800350500
400	≤ 470	300	FZR400/300	1800400300
	≤ 470	500	FZR400/500	1800400500
450	≤ 520	300	FZR450/300	1800450300
	≤ 520	500	FZR450/500	1800450500
500	≤ 575	300	FZR500/300	1800500300
	≤ 575	500	FZR500/500	1800500500
600	≤ 680	300	FZR600/300	1800600300
	≤ 680	500	FZR600/500	1800600500
700	≤ 800	300	FZR700/300	1800700300
	≤ 800	500	FZR700/500	1800700500
800	≤ 910	300	FZR800/300	1800800300
	≤ 910	500	FZR800/500	1800800500
900	≤ 1.020	300	FZR900/300	1800900300
	≤ 1.020	500	FZR900/500	1800900500
1000	≤ 1.130	300	FZR1000/300	1801000300

Wall sleeve ID (mm)	Wall sleeve OD (mm)	Wall thickness (mm)	Article code	Article number
1000	≤ 1.130	500	FZR1000/500	1801000500

Wall thickness 300 mm: The price is valid for wall sleeves with a wall thickness of up to 300 mm.
 Wall thickness 500 mm: The price is valid for wall sleeves with a wall thickness of 400 to 500 mm.
 The article numbers, article codes and GTINs for the exact wall thicknesses can be found at: www.hauff-technik.com
 Standard lengths: 200, 240, 250, 300, 365, 400, 500 mm (other lengths on request)



FZR400/300 Installation location sewage treatment plant



lengthwise watertight outer grooves



FZR100/240 - pipe section sealing

Wall sleeves

Accessories

Figure	Item	Article code	Article number	GTIN
	Formwork covers for fibre cement wall sleeve	FZR SH 80	3030531417	4052487244435
		FZR SH 100	3030531418	4052487244459
		FZR SH 125	3030531419	4052487244473
		FZR SH 150	3030531420	4052487244497
		FZR SH 200	3030531421	4052487244510
		FZR SH 250	3030556066	4052487245555
		FZR SH 300	3030556072	4052487245579
		FZR SH 350	3030556073	4052487245593
		FZR SH 400	3030556078	4052487245616

Stainless steel wall sleeve with puddle flange

for setting in concrete

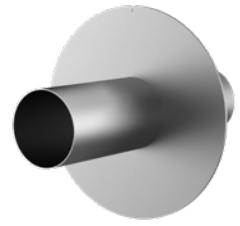

FUM A2

Puddle flange serves as water barrier and creates a force-fit connection.

Scope of delivery

- with closing covers on both sides

Tightness

- gastight and watertight



Dimensions

- Puddle flange outer diameter is equivalent to the inner diameter of the casing + approx. 210 mm (for one entry. See the brochure for detailed information)

Wall sleeve ID (mm)	External diameter of flange (mm)	Length (mm)	Article code	Article number	GTIN
100	304	200	FUM1x100/100/100 A2	911109800	4052487137249
	304	250	FUM1x100/125/125 A2	911110000	4052487021524
	304	300	FUM1x100/150/150 A2	911120000	4052487021531
150	354	200	FUM1x150/100/100 A2	911309800	4052487137317
	354	250	FUM1x150/125/125 A2	911310000	4052487021623
	354	300	FUM1x150/150/150 A2	911320000	4052487021630
200	404	200	FUM1x200/100/100 A2	911409800	4052487137348
	404	250	FUM1x200/125/125 A2	911410000	4052487021678
	404	300	FUM1x200/150/150 A2	911420000	4052487021685
250	454	200	FUM1x250/100/100 A2	911509800	4052487137379
	454	250	FUM1x250/125/125 A2	911510000	4052487021722

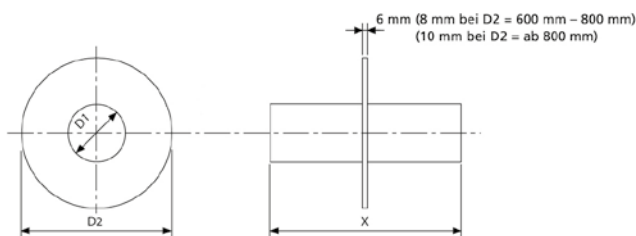

D1: wall sleeve Ø, D2: external diameter of flange

Universal wall sleeve

for any type of wall

UFR

Allows sealing in all wall types thanks to the combination of a flange and 3-ribbed seals. For setting in concrete, closed on both sides ready for installation.



USP

- flange for easy application of polymer-modified bitumen thick coatings
- Tested solution for use with pre-applied waterproofing membrane
- can be used in all types of walls

- 3 pieces of 3-ribbed seal
- 2 pieces of closing covers

Dimensions

- Flange all-around: 50mm

Tightness



- gastight and watertight



Scope of delivery

- 1 piece of wall sleeve with flange

Figure	Wall sleeve ID (mm)	Wall sleeve OD (mm)	flange edge dimension (mm)	flange surface dimension (mm)	Lenght (mm)	Article code	Packing unit	Article number	GTIN
	100	110	227	210	200	UFR100/200	1	3030300244	4052487216098
					240	UFR100/240	1	3030300245	4052487216104
					250	UFR100/250	1	3030300246	4052487216111
					300	UFR100/300	1	3030300247	4052487216128
					365	UFR100/365	1	3030300248	4052487216135
					400	UFR100/400	1	3030300249	4052487216142
					500	UFR100/500	1	3030300250	4052487216159
	150	162	282	260	200	UFR150/200	1	3030300251	4052487216166
					240	UFR150/240	1	3030300252	4052487216173
					250	UFR150/250	1	3030300253	4052487216180
					300	UFR150/300	1	3030300254	4052487216197
					365	UFR150/365	1	3030300255	4052487216203
					400	UFR150/400	1	3030300256	4052487216210
					500	UFR150/500	1	3030300257	4052487216227
	200	214	336	311	200	UFR200/200	1	3030300258	4052487216234
					240	UFR200/240	1	3030300259	4052487216241
					250	UFR200/250	1	3030300260	4052487216258
					300	UFR200/300	1	3030300261	4052487216265
					365	UFR200/365	1	3030300262	4052487216272
					400	UFR200/400	1	3030300263	4052487216289
					500	UFR200/500	1	3030300264	4052487216296
	250	264	416	384	200	UFR250/200	1	2800250200	4052487155526

Figure	Wall sleeve ID (mm)	Wall sleeve OD (mm)	flange edge dimension (mm)	flange surface dimension (mm)	Lenght (mm)	Article code	Packing unit	Article number	GTIN
	250	264	416	384	240	UFR250/240	1	2800250240	4052487155540
					250	UFR250/250	1	2800250250	4052487155557
					300	UFR250/300	1	2800250300	4052487155564
					365	UFR250/365	1	2800250365	4052487155571
					400	UFR250/400	1	2800250400	4052487155588
					500	UFR250/500	1	2800250500	4052487155625
	300	316	472	436	200	UFR300/200	1	2800030200	4052487154031
					240	UFR300/240	1	2800030240	4052487154048
					250	UFR300/250	1	2800030250	4052487154055
					300	UFR300/300	1	2800030300	4052487154062
					365	UFR300/365	1	2800030365	4052487154079
					400	UFR300/400	1	2800030400	4052487154086
					500	UFR300/500	1	2800030500	4052487154123

Customised lengths available

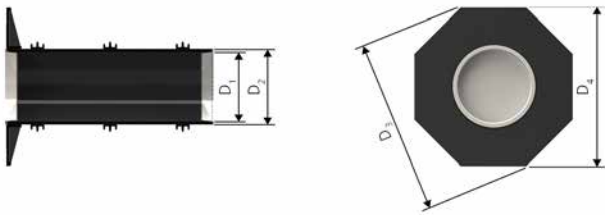

D1: wall sleeve Øi, D2: wall sleeve Øa, D3: flange edge dimension, D4: flange surface dimension



concreted UFR with PMBC



UFR in formwork

Bellmouth Wall Sleeve

for setting in concrete



BWS

For installation flush with the formwork and use of standard press seals.

USP

- frame connection system for creation of packages on site – compatible with all three sizes

- easy adjustment to the wall thickness on site – using available pipes

Tightness

- gastight and watertight up to 1.0 bar right after concreting

Wall sleeve ID (mm)	Wall sleeve OD (mm)	flange surface dimension (mm)	Minimum wall thickness (mm)	Article code	Article number	GTIN
100	110	200	120	BWS100/110	827030100	4052487196024
150	160	250	120	BWS150/160	827030150	4052487196031
200	200	300	120	BWS200/200	827030200	4052487196048

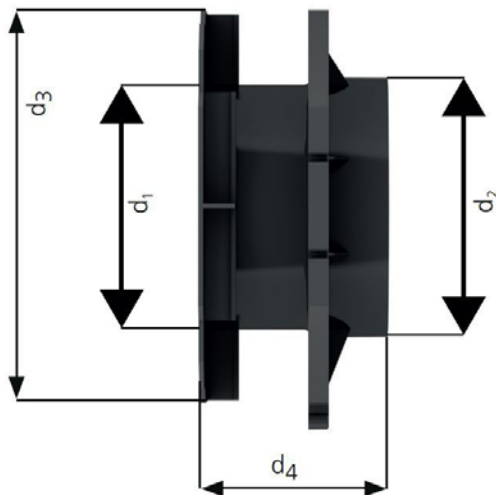

D1: wall sleeve Øi, D2: wall sleeve Øa, D3: flange surface dimension, D4: Minimum wall thickness

Wall sleeve with foldable rubber sleeve

for setting in concrete and connecting cable ducts



BWS KMA

USP

- elastic and firmly supported connection due to increased insertion depth, even with deflection of the

cable duct

- press seal installation on the inside

Tightness

- gastight and watertight

Pipe OD	Wall thickness (mm)	Article code	Article number	GTIN
110-116	200	BWS100 KMA116/200	3030578586	4052487247900
110-116	250	BWS100 KMA116/250	3030578791	4052487247917
110-116	300	BWS100 KMA116/300	3030578792	4052487247924
110-116	350	BWS100 KMA116/350	3030578793	4052487247931
110-116	365	BWS100 KMA116/365	3030578794	4052487247948
110-127	200	BWS150 KMA127/200	3030618576	4052487250719
110-127	250	BWS150 KMA127/250	3030643079	4052487250726
110-127	300	BWS150 KMA127/300	3030643304	4052487250733
110-127	350	BWS150 KMA127/350	3030643306	4052487250740
110-127	400	BWS150 KMA127/400	3030643307	4052487250757
110-127	450	BWS150 KMA127/450	3030643308	4052487250764
110-127	500	BWS150 KMA127/500	3030643309	4052487250771
160-172	200	BWS150 KMA172/200	3030583376	4052487248044
160-172	250	BWS150 KMA172/250	3030584104	4052487248051
160-172	300	BWS150 KMA172/300	3030584105	4052487248068
160-172	350	BWS150 KMA172/350	3030584106	4052487248075
160-172	365	BWS150 KMA172/365	3030584108	4052487248082
200-207	200	BWS200 KMA207/200	3030572856	4052487247955
200-207	250	BWS200 KMA207/250	3030579323	4052487247962
200-207	300	BWS200 KMA207/300	3030579324	4052487247979
200-207	350	BWS200 KMA207/350	3030579325	4052487247986
200-207	365	BWS200 KMA207/365	3030579326	4052487247993
220-228	200	BWS200 KMA228/200	3030572588	4052487248099
220-228	250	BWS200 KMA228/250	3030579339	4052487248006
220-228	300	BWS200 KMA228/300	3030579340	4052487248013
220-228	350	BWS200 KMA228/350	3030579341	4052487248020
220-228	365	BWS200 KMA228/365	3030579342	4052487248037

When connecting corrugated cable ducts, clip rings must be ordered separately. When ordering, please specify duct type and manufacturer.

Connection wall sleeve

AFR 100

For the direct connection of a smooth duct DN 110 with plug-in/glue-in socket.



USP

- integrated flange connection
- pressure-tight after concreting

Scope of delivery

- 1 piece of rubber sleeve with integrated 3-ribbed seal
- 1 piece of clamping strap

- 1 piece of sleeve cover with flange and blind cover for knock in
- 1 piece of closing cover
- 1 piece of plastic pipe DN 110 (everything pre-mounted ready for installation)



Tightness

- gastight and watertight
- radon-proof

Wall sleeve ID (mm)	Wall sleeve OD (mm)	flange edge dimension (mm)	flange surface dimension (mm)	Wall thickness (mm)	Article code	Article number	GTIN
100	110	290	260	200	AFR 100/200	3030300004	4052487143011
				240	AFR 100/240	3030300005	4052487143028
				250	AFR 100/250	3030300006	4052487143035
				300	AFR 100/300	3030300007	4052487143042
				365	AFR 100/365	3030300008	4052487143059
				400	AFR 100/400	3030300009	4052487143066
				500	AFR 100/500	3030300010	4052487143073

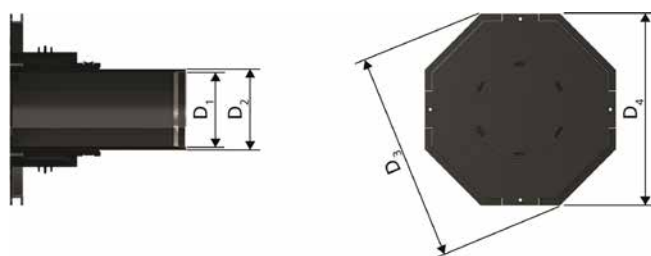

D1: wall sleeve Øi, D2: wall sleeve Øa, D3: flange edge dimension, D4: flange surface dimension



Casing tube for cable conduit connection

Connection wall sleeve

for installation in double walls/element walls

AFRE 100

For the direct connection of a smooth duct DN 110 with plug-in/glue-in socket.



USP

- integrated flange connection
- pressure-tight after concreting

Scope of delivery

- 1 piece of rubber sleeve with integrated 3-ribbed seal
- 1 piece of clamping strap
- 1 piece of sleeve cover with flange and blind cover for knock in

- 2 additional 3-ribbed seals
- 1 piece of closing cover
- 1 piece of plastic pipe DN 110 (everything pre-mounted ready for installation)



Tightness

- gastight and watertight
- radon-proof

Wall sleeve ID (mm)	Wall sleeve OD (mm)	flange edge dimension (mm)	flange surface dimension (mm)	Wall thickness (mm)	Article code	Article number	GTIN
100	110	290	260	240	AFRE 100/240	3030300011	4052487213653
				250	AFRE 100/250	3030300012	4052487139618
				300	AFRE 100/300	3030300013	4052487139625
				365	AFRE 100/365	3030300014	4052487139632
				400	AFRE 100/400	3030300015	4052487139649
				500	AFRE 100/500	3030300016	4052487139656

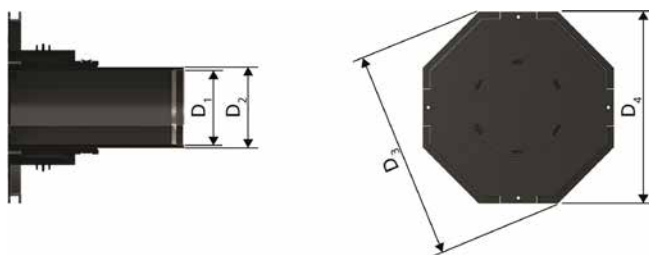

D1: wall sleeve Øi, D2: wall sleeve Øa, D3: flange edge dimension, D4: flange surface dimension



Renovation wall sleeve

SFR



For retrofit installation in bricks or concrete walls.

Dimensions

- Wall thickness: 4, 5 and 6 mm

Wall sleeve ID (mm)	Wall sleeve OD (mm)	Minimum drilling (mm)	Lenght (mm)	Article code	Article number	GTIN
100	110	200	300	SFR100/300	930000050	4052487025263
			500	SFR100/500	930000080	4052487025294
			1000	SFR100/1000	930000110	4052487025324
150	162	250	300	SFR150/300	930000140	4052487025362
			500	SFR150/500	930000160	4052487025386
			1000	SFR150/1000	930000180	4052487025409
200	214	300	300	SFR200/300	930000220	4052487025447
			500	SFR200/500	930000240	4052487025461
			1000	SFR200/1000	930000260	4052487025485

02 Wall sleeves

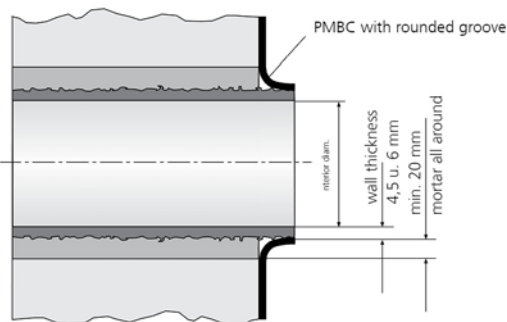

SFR - for coving connection with PMBC thick coating - installation according to DIN 18533



SFR subsequently incorporated into the masonry

Fibre cement wall sleeve

split

FZRG



Consisting of two half-forms for retrofit sealing of already installed cables or pipes. For setting in concrete or mortar. Outer grooves all round ensure a tight and force-fit bond with the wall.

Wall sleeve ID (mm)	Wall sleeve OD (mm)	Wall thickness (mm)	Article code	Article number
80	≤ 140	300	FZRG80/300	1802080300
	≤ 140	500	FZRG80/500	1802080500
100	≤ 160	300	FZRG100/300	1802100300
	≤ 160	500	FZRG100/500	1802100500
125	≤ 170	300	FZRG125/300	1802125300
	≤ 170	500	FZRG125/500	1802125500
150	≤ 195	300	FZRG150/300	1802150300
	≤ 195	500	FZRG150/500	1802150500
200	≤ 255	300	FZRG200/300	1802200300
	≤ 255	500	FZRG200/500	1802200500
250	≤ 305	300	FZRG250/300	1802250300
	≤ 305	500	FZRG250/500	1802250500
300	≤ 355	300	FZRG300/300	1802300300
	≤ 355	500	FZRG300/500	1802300500
350	≤ 405	300	FZRG350/300	1802350300
	≤ 405	500	FZRG350/500	1802350500
400	≤ 470	300	FZRG400/300	1802400300
	≤ 470	500	FZRG400/500	1802400500
450	≤ 520	300	FZRG450/300	1802450300
	≤ 520	500	FZRG450/500	1802450500
500	≤ 575	500	FZRG500/500	1802500500
600	≤ 680	300	FZRG600/300	1802600300
	≤ 680	500	FZRG600/500	1802600500
700	≤ 800	300	FZRG700/300	1802700300
	≤ 800	500	FZRG700/500	1802700500
800	≤ 910	300	FZRG800/300	1802800300
	≤ 910	500	FZRG800/500	1802800500

Wall thickness 300 mm: The price is valid for wall sleeves with a wall thickness of up to 300 mm.
 Wall thickness 500 mm: The price is valid for wall sleeves with a wall thickness of 400 to 500 mm.
 The article numbers, article codes and GTINs for the exact wall thicknesses can be found at: www.hauff-technik.com
 Standard lengths: 200, 240, 250, 300, 365, 400, 500 mm (other lengths on request)



FZRG350/300 - installation



FZRG150/350 - refurbishment in masonry



FZRG350/300 with levelling compound from installation set MSET FZRG

Accessories

Figure	Item	Article code	Article number	GTIN
	Assembly kit for fibre cement wall sleeve FZRG	MSET FZRG	3030558799	4052487246026

Stainless steel flange

for retrofit installation

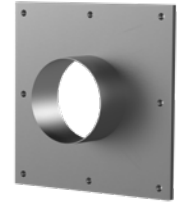

FA A2



For fixing over existing cut-outs/penetrations in walls or floor slabs.

Scope of delivery

- 1 piece of stainless steel flange
- 1 piece of surface seal
- Fastening elements

Dimensions

- Standard flange OD is equivalent to the corresponding wall sleeve ID + approx. 150 mm (for one entry)
- Standard upper length: 80 mm

Figure	Wall sleeve ID (mm)	Flange standard dimensions (mm)	Article code	Article number	GTIN
	80	170	FA1x80/80/0 A2	910820000	4052487021012
	100	185	FA1x100/80/0 A2	910830000	4052487021029
	125	205	FA1x125/80/0 A2	910840000	4052487021036
	150	225	FA1x150/80/0 A2	910850000	4052487021043
	200	350	FA1x200/80/0 A2	910870000	4052487021067
	250	400	FA1x250/80/0 A2	910880000	4052487021081
	300	450	FA1x300/80/0 A2	910890000	4052487021098
	350	500	FA1x350/80/0 A2	910893500	4052487021104
	400	550	FA1x400/80/0 A2	910900000	4052487021111
	450	600	FA1x450/80/0 A2	910900002	4052487021128
	500	650	FA1x500/80/0 A2	910900003	4052487021135

Customized dimensions available on request.

Fixing elements are included in scope of delivery.

The flange is supplied in square design up to wall sleeve inner diameter 150 mm and in round design from wall sleeve inner diameter 200 mm.

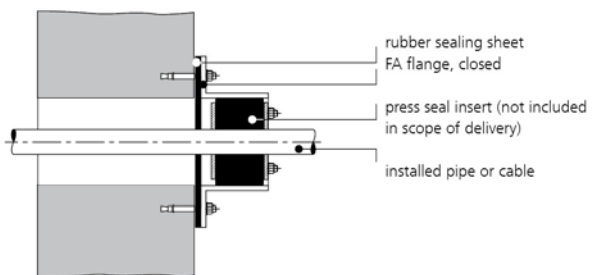

02 Wall sleeves



Accessories

Figure	Item	Article code	Article number	GTIN
	Sealant	Hybrid 7057Z	3030537533	4052487248617

03 Press seals for cables and pipes

The innovative press seals from Hauff-Technik provide you with every possible opportunity for reliable sealing of core drills or wall sleeves for one or a number of cables and pipes.

These range from closed seal inserts for first-time installation to split seal inserts for retrofit sealing of cables that have already been laid.



We can provide the ideal press seal for every requirement and task, be it tailor-made to the millimetre or suitable for universal use on site, round, oval or even square. Quick and cost-effective.

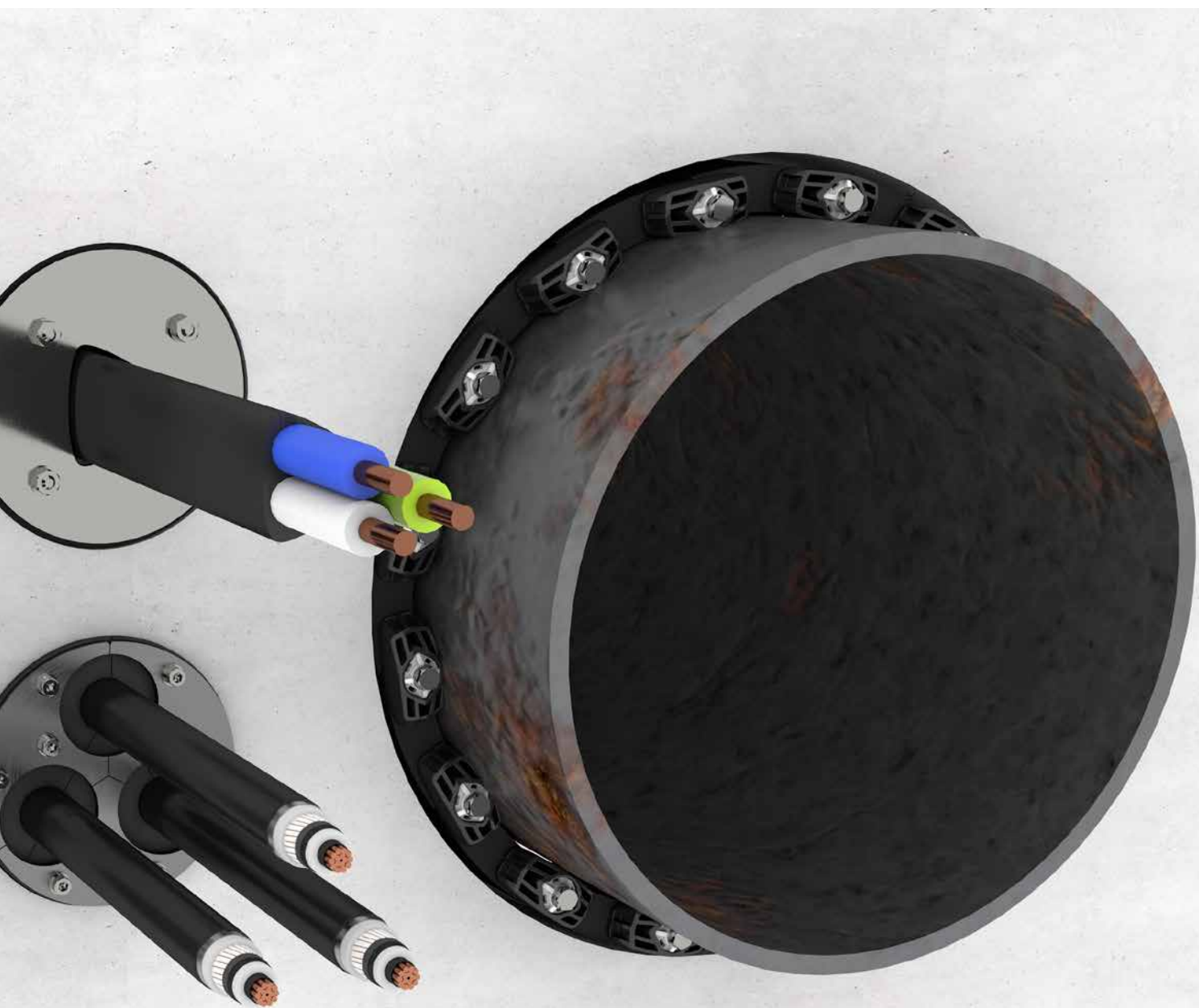

Standard press seal

with super segmented ring technology and polymer press plates



HRK SSG b40 PAGF/A4/EPDM

Press seal for sealing cables in core drills or sleeves. Split design for sealing new installed cables or cables that have already been installed.

USP

- integrated segmented-ring technology for individual adjustment to cable diameters on site
- form-fit design of the press plates

Scope of delivery

- Blind plug (for multiple cable entries)

- 1 piece of knife
- 1 piece of lubricant stick

Dimensions

- Sealing width: 40 mm

Tightness

- gastight and watertight
- radon-proof





Figure	Wall sleeve/ core drilled hole ID (mm)	Openings	Carrier pipe Øa (mm)	Article code	Packing unit	Article number	GTIN
	100	1	18-65	HRK100 SSG 1x18-65 b40 PAGF/A4/EPDM	1	3030300044	4052487129268
9					4052487223591		
	100	4	8-30	HRK100 SSG 4x8-30 b40 PAGF/A4/EPDM	1	3030300045	4052487129251
9					4052487223607		

Figure	Wall sleeve/ core drilled hole ID (mm)	Openings	Carrier pipe \varnothing_a (mm)	Article code	Packing unit	Article number	GTIN	
	150	1	36-70	HRK150 SSG 1x36-70 b40 PAGF/A4/EPDM¹⁾	1	3030300046	4052487223614	
					8		4052487223621	
70-112			HRK150 SSG 1x70-112 b40 PAGF/A4/EPDM¹⁾	1	3030300047	4052487129305		
				8		4052487223638		
		3	24-54	HRK150 SSG 3x24-54 b40 PAGF/A4/EPDM	1	1600101630	4052487129275	
					8		4052487220057	
		6	10-36	HRK150 SSG 6x10-36 b40 PAGF/A4/EPDM	1	3030300048	4052487126373	
					8		4052487223645	
		200	1	110-162	HRK200 SSG 1x110-162 b40 PAGF/A4/EPDM¹⁾	1	3030300049	4052487223652
						8		4052487223669
	3		40-72	HRK200 SSG 3x40-72 b40 PAGF/A4/EPDM	1	3030300050	4052487134576	
					8		4052487223676	

¹⁾ without blind plug for unoccupied openings



press plate with form-fitting connection

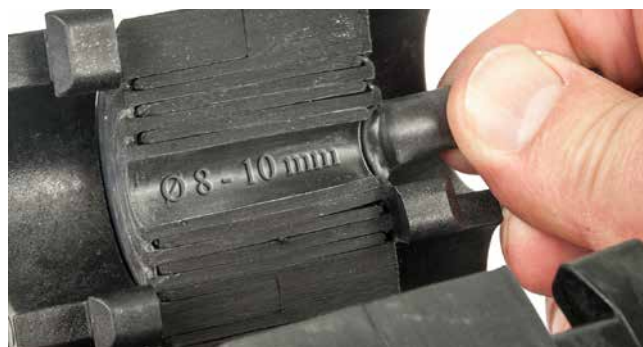

Segments with diameter marking

Standard press seal

with segmented ring technology

HRD SG b40 A2/EPDM



Press seal for sealing cables in core drills or sleeves. Split design for sealing new installed cables or cables that have already been installed.

USP

- segmented-ring technology for adjustment to pipe diameters on site

Scope of delivery

- Blind plugs
- 1 piece of lubricant stick

Dimensions

- Sealing width: 40 mm
- Press plates: 5 mm

Tightness

- gastight and watertight
- radon-proof



Figure	Wall sleeve/ core drilled hole ID (mm)	Number of cables/ medium overall	Openings	Carrier pipe Øa (mm)	Article code	Article number	GTIN	
	80	1	1	6-41	HRD80 SG 1x6-41 b40 A2/EPDM	2700100108	4052487000109	
	100	1	1	24-52	HRD100 SG 1x24-52 b40 A2/EPDM¹⁾	2700101000	4052487168038	
		4	4	8-30	HRD100 SG 4x8-30 b40 A2/EPDM¹⁾	2700102000	4052487000130	
		8	8	4-16,5	HRD100 SG 8x4-16,5 b40 A2/EPDM	2700103000	4052487000147	
		2		1	22-50	HRD100 SG 1x22-50+1x5-12 b40 A2/EPDM	3030548511	4052487245401
				1	5-12			
		5		2	8-30	HRD100 SG 2x8-30+3x4-16,5 b40 A2/EPDM	2700103500	4052487000154
				3	4-16,5			
	6		2	9-17	HRD100 SG 2x9-17+4x5-15 b40 A2/EPDM	3030474668	4052487241274	
			4	5-15				

Figure	Wall sleeve/ core drilled hole ID (mm)	Number of cables/ medium overall	Openings	Carrier pipe Øa (mm)	Article code	Article number	GTIN
	104	1	1	24-52	HRD104 SG 1x24-52 b40 A2/EPDM	2700103615	4052487129695
		4	4	8-30	HRD104 SG 4x8-30 b40 A2/EPDM	2700103610	4052487127370
		8	8	4-16,5	HRD104 SG 8x4-16,5 b40 A2/EPDM	2700103620	4052487129213
	125	3	3	10-40	HRD125 SG 3x10-40 b40 A2/EPDM	2700103750	4052487063913
	125	6	6	6-31	HRD125 SG 6x6-31 b40 A2/EPDM	2700103800	4052487000161
		10	10	4-16,5	HRD125 SG 10x4-16,5 b40 A2/EPDM	2700103850	4052487000178

03 Press seals

Figure	Wall sleeve/ core drilled hole ID (mm)	Number of cables/ medium overall	Openings	Carrier pipe Øa (mm)	Article code	Article number	GTIN
	150	1	1	12-75	HRD150 SG 1x12-75 b40 A2/EPDM¹⁾	2700103996	4052487063951
			1	75-110	HRD150 SG 1x75-110 b40 A2/EPDM¹⁾	2700103998	4052487063968
		3	3	22-54	HRD150 SG 3x22-54 b40 A2/EPDM¹⁾	2700104000	4052487000185
		6	6	8-35	HRD150 SG 6x8-35 b40 A2/EPDM¹⁾	2700105000	4052487000192
		9	9	6-25	HRD150 SG 9x6-25 b40 A2/EPDM	2700106000	4052487000208
		10	4	8-30	HRD150 SG 4x8- 30+6x4-16,5 b40 A2/EPDM	2700106500	4052487000215
	6		4-16,5				
	200	7	3	6-54	HRD200 SG 3x6-54+4x6-26 b40 A2/EPDM	2700107000	4052487000222
			4	6-26			
		15	7	10-32	HRD200 SG 7x10- 32+8x3,5-16,5 b40 A2/ EPDM	2700108000	4052487000239
	200	15	8	3,5-16,5	HRD200 SG 7x10- 32+8x3,5-16,5 b40 A2/ EPDM	2700108000	4052487000239

¹⁾ This assignment is also available in the optimized HRK SSG technology.



HRD150 SG 6x8-36 5 - individually adjustable to diameters of cables



HRD150 SG installed in fibre cement wall sleeves

03 Press seals

Accessories

Figure	Item	Width (mm)	Article code	Article number	GTIN
	Adapter ring for retrofit sealing	40	HRD150 SG/ARG	5060120155	4052487233330

Radial Expansion Ring Seal

Cable sealing with elastomer shrink technology



RSRT

For sealing a power cable in core drill holes or wall sleeves.

USP

- Quick and easy installation
- ideal for installation in confined spaces and for cables inserted at an angle

Dimensions

- For core drills ID: 99 - 102 mm

Tightness

- gastight and watertight

Number of cables/medium	suitable for medium pipe OD (mm)	Article code	Article number	GTIN
1	28-50	RSRT100 1x28-50	3030598626	4052487251631
1	48-63	RSRT100 1x48-63	3030598620	4052487251648

Customized press seal

sealing width 30 mm

HRD b30



Customised press seal in closed or split design for sealing new or already installed cables/pipes. The seal is manufactured according to customer specific dimensional specifications - e.g. eccentric, with overlapping flange or for multiple and mixed entries.

Scope of delivery

- 1 piece of lubricant stick

Dimensions

- Sealing width: 30 mm
- Press plates: 5 mm

- For core drills/wall sleeves Ø: 40 mm and higher
- for cables/pipes from Øa: 5 mm

Tightness

- gastight and watertight
- radon-proof



Figure	Wall sleeve/ core drilled hole ID (mm)	Article code
	50	HRD50 ZxD b30 A2/EPDM55
	60	HRD60 ZxD b30 A2/EPDM55
	70	HRD70 ZxD b30 A2/EPDM55
	80	HRD80 ZxD b30 A2/EPDM55
	100	HRD100 ZxD b30 A2/EPDM55
	125	HRD125 ZxD b30 A2/EPDM55
	150	HRD150 ZxD b30 A2/EPDM55
	200	HRD200 ZxD b30 A2/EPDM55
	250	HRD250 ZxD b30 A2/EPDM55
	50	HRD50 G ZxD b30 A2/EPDM55
	60	HRD60 G ZxD b30 A2/EPDM55
	70	HRD70 G ZxD b30 A2/EPDM55
	80	HRD80 G ZxD b30 A2/EPDM55
	100	HRD100 G ZxD b30 A2/EPDM55
	125	HRD125 G ZxD b30 A2/EPDM55
	150	HRD150 G ZxD b30 A2/EPDM55
	200	HRD200 G ZxD b30 A2/EPDM55
	250	HRD250 G ZxD b30 A2/EPDM55
	300	HRD300 G ZxD b30 A2/EPDM55

Z = Number of passes, D = Measured outer diameter of the media line
Customized diameters available.

For maximum cable configuration please refer to configuration table

Further variants: Blind sealing element, order no.: e.g. HRD117 1x0 b30. Split, eccentric sealing insert, order no.: e.g. HRD156 PV G 1x45 ex23. All individual press seal variants are also available with an overlapping flange.



HRD150 G b30 with multiple entry

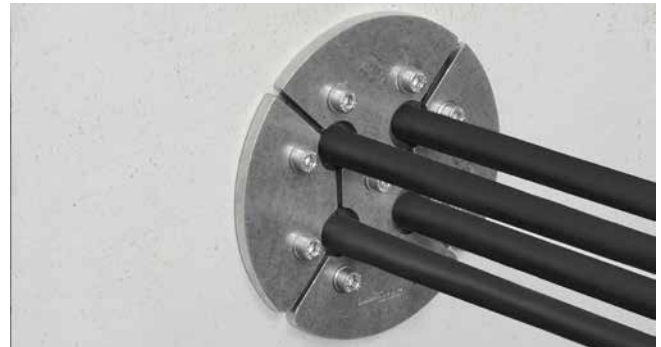

HRD200 G b30 installed in a steel pipe

Customized press seal

sealing width 60 mm

HRD b60



Customised press seal in closed or split design for sealing new or already installed cables/pipes. The seal is manufactured according to customer specific dimensional specifications - e.g. eccentric, with overlapping flange or for multiple and mixed entries.

Scope of delivery

- 1 piece of lubricant stick

Dimensions



- Sealing width: 60 mm
- Press plates: 5 mm

- For core drills/wall sleeves \varnothing : 40 mm and higher
- for cables/pipes from \varnothing a: 5 mm



Tightness

- gastight and watertight
- radon-proof

Figure	Wall sleeve/ core drilled hole ID (mm)	Article code
	50	HRD50 ZxD b60 A2/EPDM55
	60	HRD60 ZxD b60 A2/EPDM55
	70	HRD70 ZxD b60 A2/EPDM55
	80	HRD80 ZxD b60 A2/EPDM55
	100	HRD100 ZxD b60 A2/EPDM55
	125	HRD125 ZxD b60 A2/EPDM55
	150	HRD150 ZxD b60 A2/EPDM55
	200	HRD200 ZxD b60 A2/EPDM55
	250	HRD250 ZxD b60 A2/EPDM55
	50	HRD50 G ZxD b60 A2/EPDM55
	60	HRD60 G ZxD b60 A2/EPDM55
	70	HRD70 G ZxD b60 A2/EPDM55
	80	HRD80 G ZxD b60 A2/EPDM55
	100	HRD100 G ZxD b60 A2/EPDM55
	125	HRD125 G ZxD b60 A2/EPDM55
	150	HRD150 G ZxD b60 A2/EPDM55
	200	HRD200 G ZxD b60 A2/EPDM55
	250	HRD250 G ZxD b60 A2/EPDM55
	300	HRD300 G ZxD b60 A2/EPDM55

Z = Number of passes, D = Measured outer diameter of the media line
Further sizes up to \varnothing 1500 mm available on request with short lead times.
Customized diameters available.

For maximum cable configuration please refer to configuration table

Further variants: Blind sealing element, order no.: e.g. HRD117 1x0 b30. Split, eccentric sealing insert, order no.: e.g. HRD156 PV G 1x45 ex23. All individual press seal variants are also available with an overlapping flange.



HRD100 0 b60 blind seal



HRD150 G 2x18+2x27

Customized press seal

with integrated test valve

HRD PV b60

Individual press seal with integrated test valve to test leakage without additional effort directly after installation and also for simple error search in the event of leakages. Available in a closed or split version to seal cables which have been installed or are to be installed. The seal is manufactured according to customer specific dimensional specifications - e.g. eccentric, with overlapping flange or for multiple and mixed entries.



USP

- with integrated test valve
- simple monitoring/control tests possible

Scope of delivery

- 1 piece of lubricant stick
- 1 piece of Identification sign

Dimensions

- Sealing width: 2 x 30 mm
- Press plates: 5 mm
- For core drills/wall sleeves \varnothing : 80 - 300 mm



Tightness

- gastight and watertight
- radon-proof

Figure	Wall sleeve/ core drilled hole ID (mm)	Article code
	80	HRD80 PV ZxD b60 A2/EPDM55
	100	HRD100 PV ZxD b60 A2/EPDM55
	125	HRD125 PV ZxD b60 A2/EPDM55
	150	HRD150 PV ZxD b60 A2/EPDM55
	200	HRD200 PV ZxD b60 A2/EPDM55
	250	HRD250 PV ZxD b60 A2/EPDM55
	300	HRD300 PV ZxD b60 A2/EPDM55
	80	HRD80 PV G ZxD b60 A2/EPDM55
	100	HRD100 PV G ZxD b60 A2/EPDM55
	125	HRD125 PV G ZxD b60 A2/EPDM55
	150	HRD150 PV G ZxD b60 A2/EPDM55
	200	HRD200 PV G ZxD b60 A2/EPDM55
	250	HRD250 PV G ZxD b60 A2/EPDM55
	300	HRD300 PV G ZxD b60 A2/EPDM55

Z = Number of passes, D = Measured outer diameter of the media line
Customized diameters available.

For maximum cable configuration please refer to configuration table

Further variants: Blind sealing element, order no.: e.g. HRD117 1x0 b30. Split, eccentric sealing insert, order no.: e.g. HRD156 PV G 1x45 ex23. All individual press seal variants are also available with an overlapping flange.



HRD150 PV G in core drill

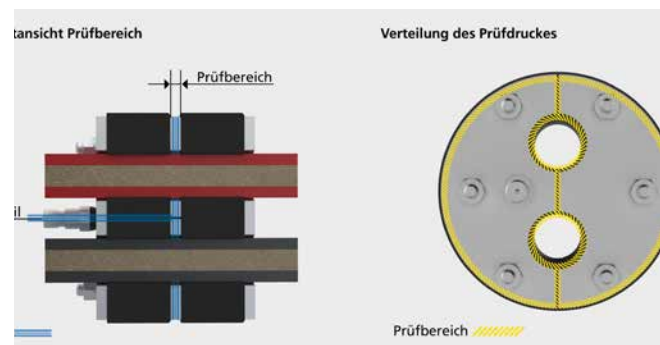

HRD150 PV G in core drill

Test pump with pressure gauge

for MSH PolySafe/FW Basic and HRD PV



DIGIT PPM

Manual test air pump with digital pressure gauge (suitable up to 20 bar / 300 psi). Suitable for leak testing of individual press seals and multi-line building entries with integrated test valve.

Scope of delivery

- includes compressed air hose with valve connection

Article code	Article number	GTIN
DIGIT PPM	1551001121	4052487168472



03 Press seals

Modular seal

Modular pipe seal

GKD



For sealing new or already installed pipes in core drill holes or wall sleeves. The modular design allows the use of all possible pipe types and diameter combinations.

USP

- with integrated installation control - no torque wrench required
- no retightening required
- no loose parts thanks to moulded nuts

Scope of delivery

- 1 piece of lubricant stick

Tightness

- gastight and watertight
- radon-proof



EPDM

Min. annular space (mm)	Max. annular space (mm)	Carrier pipe OD (mm)	Required wall thickness (mm)	Article code
12,7	16	21,3 - 323,9	75	X * GKD200 EPDM ¹⁾
16	20	25 - 323,9		X * GKD275 EPDM ¹⁾
18,5	23	58 - 463	100	X * GKD300 EPDM
23,25	26	60,3 - 463		X * GKD315 EPDM
24	30	152,2 - 716	110	X * GKD325 EPDM
25,5	34	30 - 323,9	120	X * GKD340 EPDM
32	42	40 - 406,4		X * GKD360 EPDM
36,5	43	168,3 - 1230	150	X * GKD400 EPDM
37	48,5	60,3 - 323,9	140	X * GKD410 EPDM
29	36	177,8 - 1230	125	X * GKD425 EPDM
45	52	168,3 - 1230	150	X * GKD440 EPDM
41,3	48,5	108 - 1230		X * GKD475 EPDM
62	71,5	156 - 1230	165	X * GKD500 EPDM
58	63,5	177,8 - 1230		X * GKD525 EPDM
50	58	152 - 1230		X * GKD575 EPDM
90	100	304 - 3000	205	X * GKD615 EPDM
77	84	177,8 - 2020	165	X * GKD650 EPDM

¹⁾ Due to the small size of the pressure plates, nuts are not moulded and without installation control.

NBR

Min. annular space (mm)	Max. annular space (mm)	Carrier pipe OD (mm)	Required wall thickness (mm)	Article code
12,7	16	21,3 - 323,9	75	X * GKD200 NBR ¹⁾
16	20	25 - 90		X * GKD275 NBR ¹⁾
18,5	23	58 - 463	100	X * GKD300 NBR
23,25	26	60,3 - 463		X * GKD315 NBR
24	30	152,2 - 716	110	X * GKD325 NBR
25,5	34	30 - 323,9	120	X * GKD340 NBR
32	42	40 - 406,4		X * GKD360 NBR
36,5	43	168,3 - 1230	150	X * GKD400 NBR
37	48,5	60,3 - 323,9	140	X * GKD410 NBR
29	36	177,8 - 1230	125	X * GKD425 NBR
45	52	168,3 - 1230	150	X * GKD440 NBR
41,3	48,5	108 - 1230		X * GKD475 NBR
62	71,5	156 - 1230	165	X * GKD500 NBR
58	63,5	177,8 - 1230		X * GKD525 NBR
50	58	152 - 1230		X * GKD575 NBR
90	100	304 - 3000	205	X * GKD615 NBR
77	84	177,8 - 2020	165	X * GKD650 NBR

¹⁾ Due to the small size of the pressure plates, nuts are not moulded and without installation control.

X = number of links, article number on demand.

The complete article number results from the number of links

For pipes

Carrier pipe OD (mm)	Number of segments	Type	Required wall thickness (mm)	Article number	GTIN
25-33	6	GKD275	75	3030420544	4052487240079
30-38	7	GKD275	75	3030474456	4052487240642
38-44	6	GKD200	75	3030438186	4052487240086
48-54	7	GKD200	75	3030426876	4052487240093
32-49	5	GKD340	120	3030474461	4052487240635
58-63	6	GKD300	100	1410030006	4052487159623
73-78	8	GKD315	100	1410031508	4052487144186
79-88	8	GKD300	100	1410030008	4052487144070
53-76	5	GKD410	140	3030412078	4052487232753
66-86	6	GKD360	120	3030420547	4052487240109
82-99	9	GKD340	120	3030421880	4052487240116
98-103	10	GKD315	100	1410031510	4052487142168
104-113	10	GKD300	100	1410030010	4052487142137
108-114	7	GKD475	150	1410047507	4052487142502
132-149	13	GKD340	120	3030430136	4052487240123
148-152	14	GKD315	100	1410031514	4052487144230
153-153	15	GKD315	100	1410031515	4052487144247
154-160	13	GKD300	100	1410030013	4052487144117
161-163	14	GKD300	100	1410030014	4052487144124
	9	GKD475	150	1410047509	4052487145398
167-167	10	GKD475	150	1410047510	4052487145404
169-177	7	GKD400	150	1410040007	4052487157506
178-189	7	GKD425	125	1410042507	4052487190152
190-202	9	GKD325	110	1410032509	4052487144377
203-203	19	GKD315	100	1410031519	4052487144285
204-213	17	GKD300	100	1410030017	4052487144155
157-167	7	GKD500	165	1410050007	4052487189576
168-176	8	GKD500	165	1410050008	4052487142564
178-184	8	GKD525	165	1410052508	4052487143554
185-195	10	GKD575	165	1410057510	4052487143561
203-203	11	GKD475	150	1410047511	4052487145411
204-208	8	GKD440	150	1410044008	4052487142434
204-217	12	GKD475	150	1410047512	4052487143189
218-227	9	GKD400	150	1410040009	4052487144568
228-242	9	GKD425	125	1410042509	4052487144834
243-252	11	GKD325	110	1410032511	4052487144391
253-253	23	GKD315	100	1410031523	4052487144322
254-263	21	GKD300	100	1410030021	4052487189224
207-222	9	GKD500	165	1410050009	4052487145855

Carrier pipe OD (mm)	Number of segments	Type	Required wall thickness (mm)	Article number	GTIN
223-234	9	GKD525	165	1410052509	4052487146142
235-245	12	GKD575	165	1410057512	4052487146470
	9	GKD440	150	1410044009	4052487145121
253-260	10	GKD440	150	1410044010	4052487145138
261-266	14	GKD475	150	1410047514	4052487143196
264-277	10	GKD400	150	1410040010	4052487144575
278-292	11	GKD425	125	1410042511	4052487144858
293-302	13	GKD325	110	1410032513	4052487144414
303-303	27	GKD315	100	1410031527	4052487144360
304-313	25	GKD300	100	1410030025	4052487189262
257-276	11	GKD500	165	1410050011	4052487145879
277-284	11	GKD525	165	1410052511	4052487146166
285-295	14	GKD575	165	1410057514	4052487146494
296-310	11	GKD440	150	1410044011	4052487145145
311-313	16	GKD475	150	1410047516	4052487145442
314-329	12	GKD400	150	1410040012	4052487143097
330-341	12	GKD425	125	1410042512	4052487144865
342-342	13	GKD425	125	1410042513	4052487144872
343-352	15	GKD325	110	1410032515	4052487144438
353-353	31	GKD315	100	1410031533	4052487189835
354-360	28	GKD300	100	1410030028	4052487189293
307-326	12	GKD500	165	1410050012	4052487145886
327-332	12	GKD525	165	1410052512	4052487146180
333-334	13	GKD525	165	1410052513	4052487146197
334-345	16	GKD575	165	1410057516	4052487146517
346-360	13	GKD440	150	1410044013	4052487145169
361-367	19	GKD475	150	1410047519	4052487145473
364-377	14	GKD400	150	1410040014	4052487144605
378-392	14	GKD425	125	1410042514	4052487143141
390-402	17	GKD325	110	1410032517	4052487144445
395-403	33	GKD315	100	1410031535	4052487189859
404-413	30	GKD300	100	1410030032	4052487189316
332-346	13	GKD650	165	1410065013	4052487147415
357-376	14	GKD500	165	1410050014	4052487145909
374-384	14	GKD525	165	1410052514	4052487146203
384-384	17	GKD575	165	1410057517	4052487146524
385-400	18	GKD575	165	1410057518	4052487146531
396-410	14	GKD440	150	1410044014	4052487145176
403-417	21	GKD475	150	1410047521	4052487145497
414-427	15	GKD400	150	1410040015	4052487144612

For pipes

Carrier pipe OD (mm)	Number of segments	Type	Required wall thickness (mm)	Article number	GTIN
428-442	16	GKD425	125	1410042516	4052487143158
440-452	19	GKD325	110	1410032519	4052487144469
448-453	37	GKD315	100	1410031539	4052487189897
454-463	34	GKD300	100	1410030036	4052487189354
350-370	9	GKD615	205	1410061509	4052487146852
382-396	15	GKD650	165	1410065015	4052487147439
407-417	15	GKD500	165	1410050015	4052487145916
418-426	16	GKD500	165	1410050016	4052487145923
423-434	16	GKD525	165	1410052516	4052487146227
434-435	19	GKD575	165	1410057519	4052487146548
436-450	20	GKD575	165	1410057520	4052487146555
446-460	16	GKD440	150	1410044016	4052487145190
453-467	23	GKD475	150	1410047523	4052487145510
464-477	17	GKD400	150	1410040017	4052487143103
478-488	17	GKD425	125	1410042517	4052487144896
489-492	18	GKD425	125	1410042518	4052487144902
490-502	21	GKD325	110	1410032521	4052487144483
400-420	10	GKD615	205	1410061510	4052487146869
432-446	16	GKD650	165	1410065016	4052487147446
457-476	17	GKD500	165	1410050017	4052487145930
473-484	17	GKD525	165	1410052517	4052487146234
484-486	21	GKD575	165	1410057521	4052487146562
487-500	22	GKD575	165	1410057522	4052487146579
496-510	17	GKD440	150	1410044017	4052487145206
503-516	25	GKD475	150	1410047525	4052487145534
514-527	19	GKD400	150	1410040019	4052487143110
517-517	26	GKD475	150	1410047526	4052487145541
528-542	19	GKD425	125	1410042519	4052487144919
540-552	23	GKD325	110	1410032523	4052487144506
450-470	11	GKD615	205	1410061511	4052487146876
482-492	18	GKD650	165	1410065018	4052487147460
507-526	19	GKD500	165	1410050019	4052487145954
523-534	19	GKD525	165	1410052519	4052487146258
534-537	23	GKD575	165	1410057523	4052487146586
538-550	24	GKD575	165	1410057524	4052487146593
546-560	19	GKD440	150	1410044019	4052487145220
553-554	27	GKD475	150	1410047527	4052487145558
555-567	28	GKD475	150	1410047528	4052487145565
564-576	20	GKD400	150	1410040020	4052487143127

Carrier pipe OD (mm)	Number of segments	Type	Required wall thickness (mm)	Article number	GTIN
577-577	21	GKD400	150	1410040021	4052487142311
578-592	21	GKD425	125	1410042521	4052487142380
590-602	25	GKD325	110	1410032525	4052487144520

¹⁾ Due to the small size of the pressure plates, nuts are not moulded and without installation control.



GKD400 - installation preparation with lubricant GM



GKD400 - mounting of segments



GKD400 - tightening of segments



GKD with one segment not tightened - installation error imcarriertely detected.

03 Press seals

Accessories

Figure	Item	Article number	GTIN
	Lubricant stick for press seals	5180040008	4052487233378

Standard press seal

with continuously variable super segment ring technology

HSD SSG



For sealing new or already installed pipes in core drill holes or wall sleeves.
Continuously adjustable to cable diameter on site.

USP

- Visual and physical installation control through integrated inspection window
- integrated super segmented ring technology for individual adjustment to cable/pipe diameter on site
- Segments with diameter marking

Dimensions

- Sealing width up to Ø 250 mm: 40 mm
- Sealing width for Ø 300 mm: 50 mm

Tightness

- gastight and watertight
- radon-proof



Wall sleeve/ core drilled hole ID (mm)	Openings	Carrier pipe Øa (mm)	Article code	Packing unit	Article number	GTIN
100	1	18-65	HSD100 SSG 1x18-65 b40 A2/EPDM	1	3030300060	4052487165655
				15		4052487223737
150	1	70-112	HSD150 SSG 1x70-112 b40 A2/EPDM	1	3030300064	4052487129015
				15		4052487223751
200	1	110-162	HSD200 SSG 1x110-162 b40 A2/EPDM	1	3030300068	4052487129022
				15		4052487223799
250	1	159-211	HSD250 SSG 1x159-211 b40 A2/EPDM¹⁾	1	3030300072	4052487129374
				4		4052487223805
300	1	200-252	HSD300 SSG 1x200-252 b50 A2/EPDM¹⁾	1	3030300076	4052487129381
				4		4052487223812

¹⁾ Not blind sealed as standard, blind seal is available as an optional accessory.



super segment ring technology with exact diameter marking



U-profile press segments made of stainless steel A2 (AISI 304L) or A4 (AISI 316L)

Accessories

Figure	Item	Article code	Article number	GTIN
	Closing cover for standard press seals HSD SSG	HSD250 SSG D	5199990021	4052487233514
	Closing cover for standard press seals HSD SSG	HSD300 SSG D	5199990019	4052487233538

Standard press seal

with stepped variable super segmented ring technology

HSD SSG

For sealing new or already installed pipes in core drill holes or wall sleeves. Can be adapted to the most common cable diameters on site.



USP

- Visual and physical installation control through integrated inspection window
- integrated super segmented ring technology for individual adjustment to cable/pipe diameter on site

- Segments with diameter marking

Dimensions

- Sealing width: 40 mm

Tightness

- gastight and watertight
- radon-proof



Figure	Wall sleeve/ core drilled hole ID (mm)	Openings	Carrier pipe Øa (mm)	Article code	Packing unit	Article number	GTIN
	100	1	25/32/40/50/63	HSD100 SSG 1x25/32/40/50/63 b40 A2/EPDM	1	3030300058	4052487121286
					15		4052487223713
	150	1	75/90/110	HSD150 SSG 1x75/90/110 b40 A2/ EPDM	1	3030300062	4052487121804
					15		4052487223744
	200	1	110/125/135/160	HSD200 SSG 1x110/125/135/160 b40 A2/EPDM	1	3030300067	4052487123624
					15		4052487223782

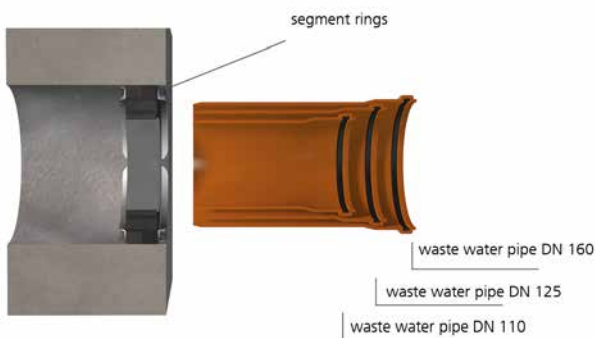

The HSD200 SSG 1x110/125/135/160 b40 A2/EPDM55 annular space gasket can be used to seal standard pipes Øa 110, 125 and 160.



Visual and physical installation control through integrated inspection window



blind closed

Standard press seal

sealing width 40 mm

HSD b40

For sealing new or already installed pipes in core drill holes or wall sleeves. Available for delivery for all standard pipe sizes.



USP

- Visual and physical installation control through integrated inspection window

Tightness

- gastight and watertight
- radon-proof



Dimensions

- Sealing width: 40 mm

A2/EPDM

Wall sleeve/ core drilled hole ID (mm)	suitable for medium pipe OD (mm)	Article code	Article number	GTIN
80	25-27	HSD80 1x25 b40 A2/EPDM	3030567408	4052487246330
	32-34	HSD80 1x32 b40 A2/EPDM	3030567403	4052487246323
	40-43	HSD80 1x40 b40 A2/EPDM	3030567412	4052487246347
100	32-34	HSD100 1x32 b40 A2/EPDM	1650010032	4052487121347
	40-43	HSD100 1x40 b40 A2/EPDM	1650010040	4052487121408
	48-51	HSD100 1x48 b40 A2/EPDM	1650010048	4052487121460
	60-63.5	HSD100 1x60 b40 A2/EPDM	1650010060	4052487121521
125	60-63.5	HSD125 1x60 b40 A2/EPDM	1650012060	4052487121583
	75-77	HSD125 1x75 b40 A2/EPDM	1650012075	4052487121644
	78-81	HSD125 1x78 b40 A2/EPDM	1650012085	4052487121705
150	78-81	HSD150 1x78 b40 A2/EPDM	1650015078	4052487121828
	88-92	HSD150 1x88 b40 A2/EPDM	1650015088	4052487121880
	110-113	HSD150 1x110 b40 A2/EPDM	1650015110	4052487121941
200	110-113	HSD200 1x110 b40 A2/EPDM	1650020100	4052487122047
	114-119	HSD200 1x114 b40 A2/EPDM	1650020110	4052487122108
	125-128	HSD200 1x125 b40 A2/EPDM	1650020120	4052487122160
	133-136	HSD200 1x133 b40 A2/EPDM	1650020130	4052487122221
	139-141	HSD200 1x139 b40 A2/EPDM	1650020140	4052487122283
	159-163	HSD200 1x159 b40 A2/EPDM	1650020150	4052487122344
250	159-163	HSD250 G 1x159 b40 A2/EPDM	1650025150	4052487122443
	168-171	HSD250 G 1x168 b40 A2/EPDM	1650025160	4052487122504
	177-181	HSD250 G 1x177 b40 A2/EPDM	1650025170	4052487122566
	200-201	HSD250 G 1x200 b40 A2/EPDM	1650025200	4052487122627
	210-211	HSD250 G 1x210 b40 A2/EPDM	1650025210	4052487122689
300	198-202	HSD300 G 1x200 b40 A2/EPDM	1650030200	4052487122788
	208-212	HSD300 G 1x210 b40 A2/EPDM	1650030210	4052487122849
	217-221	HSD300 G 1x219 b40 A2/EPDM	1650030220	4052487122900
	223-227	HSD300 G 1x225 b40 A2/EPDM	1650030230	4052487122962
	248-252	HSD300 G 1x250 b40 A2/EPDM	1650030250	4052487123020

Wall sleeve/ core drilled hole ID (mm)	suitable for medium pipe OD (mm)	Article code	Article number	GTIN
400	273-276	HSD400 G 1x273 b40 A2/EPDM	1650040270	4052487123082
	277-282	HSD400 G 1x277 b40 A2/EPDM	1650040280	4052487123143
	315-321	HSD400 G 1x315 b40 A2/EPDM	1650040310	4052487123204
	324-328	HSD400 G 1x324 b40 A2/EPDM	1650040320	4052487123266
500	398-402	HSD500 G 1x400 b40 A2/EPDM	1650050400	4052487123327
	427-431	HSD500 G 1x429 b40 A2/EPDM	1650050430	4052487123389
	448-452	HSD500 G 1x450 b40 A2/EPDM	1650050450	4052487123440

A4/EPDM

Wall sleeve/ core drilled hole ID (mm)	suitable for medium pipe OD (mm)	Article code	Article number	GTIN
100	32-34	HSD100 1x32 b40 A4/EPDM	1650010036	4052487121378
	40-43	HSD100 1x40 b40 A4/EPDM	1650010044	4052487121439
	48-51	HSD100 1x48 b40 A4/EPDM	1650010052	4052487121491
	60-63.5	HSD100 1x60 b40 A4/EPDM	1650010064	4052487121552
125	60-63.5	HSD125 1x60 b40 A4/EPDM	1650012064	4052487121613
	75-77	HSD125 1x75 b40 A4/EPDM	1650012079	4052487121675
	78-81	HSD125 1x78 b40 A4/EPDM	1650012089	4052487121736
150	78-81	HSD150 1x78 b40 A4/EPDM	1650015082	4052487121859
	88-92	HSD150 1x88 b40 A4/EPDM	1650015092	4052487121910
	110-113	HSD150 1x110 b40 A4/EPDM	1650015113	4052487121972
200	110-113	HSD200 1x110 b40 A4/EPDM	1650020104	4052487122078
	114-119	HSD200 1x114 b40 A4/EPDM	1650020114	4052487122139
	125-128	HSD200 1x125 b40 A4/EPDM	1650020124	4052487122191
	133-136	HSD200 1x133 b40 A4/EPDM	1650020134	4052487122252
	139-141	HSD200 1x139 b40 A4/EPDM	1650020144	4052487122313
	159-163	HSD200 1x159 b40 A4/EPDM	1650020154	4052487122375
250	159-163	HSD250 G 1x159 b40 A4/EPDM	1650025154	4052487122474
	168-171	HSD250 G 1x168 b40 A4/EPDM	1650025164	4052487122535
	177-181	HSD250 G 1x177 b40 A4/EPDM	1650025174	4052487122597
	200-201	HSD250 G 1x200 b40 A4/EPDM	1650025204	4052487122658
	210-211	HSD250 G 1x210 b40 A4/EPDM	1650025214	4052487122719
300	198-202	HSD300 G 1x200 b40 A4/EPDM	1650030204	4052487122818
	208-212	HSD300 G 1x210 b40 A4/EPDM	1650030214	4052487122870
	217-221	HSD300 G 1x219 b40 A4/EPDM	1650030224	4052487122931
	223-227	HSD300 G 1x225 b40 A4/EPDM	1650030234	4052487122993
	248-252	HSD300 G 1x250 b40 A4/EPDM	1650030254	4052487123051
400	273-276	HSD400 G 1x273 b40 A4/EPDM	1650040274	4052487123112
	277-282	HSD400 G 1x277 b40 A4/EPDM	1650040284	4052487123174
	315-321	HSD400 G 1x315 b40 A4/EPDM	1650040314	4052487123235
	324-328	HSD400 G 1x324 b40 A4/EPDM	1650040324	4052487123297
500	398-402	HSD500 G 1x400 b40 A4/EPDM	1650050404	4052487123358
	427-431	HSD500 G 1x429 b40 A4/EPDM	1650050434	4052487123419
	448-452	HSD500 G 1x450 b40 A4/EPDM	1650050454	4052487123471

A2/NBR

Wall sleeve/ core drilled hole ID (mm)	suitable for medium pipe OD (mm)	Article code	Article number	GTIN
100	32-34	HSD100 1x32 b40 A2/NBR	1650010033	4052487121354
	40-43	HSD100 1x40 b40 A2/NBR	1650010041	4052487121415
	48-51	HSD100 1x48 b40 A2/NBR	1650010049	4052487121477
	60-63.5	HSD100 1x60 b40 A2/NBR	1650010061	4052487121538
125	60-63.5	HSD125 1x60 b40 A2/NBR	1650012061	4052487121590
	75-77	HSD125 1x75 b40 A2/NBR	1650012076	4052487121651
	78-81	HSD125 1x78 b40 A2/NBR	1650012086	4052487121712
150	78-81	HSD150 1x78 b40 A2/NBR	1650015079	4052487121835
	88-92	HSD150 1x88 b40 A2/NBR	1650015089	4052487121897
	110-113	HSD150 1x110 b40 A2/NBR	1650015111	4052487121958
200	110-113	HSD200 1x110 b40 A2/NBR	1650020101	4052487122054
	114-119	HSD200 1x114 b40 A2/NBR	1650020111	4052487122115
	125-128	HSD200 1x125 b40 A2/NBR	1650020121	4052487122177
	133-136	HSD200 1x133 b40 A2/NBR	1650020131	4052487122238
	139-141	HSD200 1x139 b40 A2/NBR	1650020141	4052487122290
	159-163	HSD200 1x159 b40 A2/NBR	1650020151	4052487122351
250	159-163	HSD250 G 1x159 b40 A2/NBR	1650025151	4052487122450
	168-171	HSD250 G 1x168 b40 A2/NBR	1650025161	4052487122511
	177-181	HSD250 G 1x177 b40 A2/NBR	1650025171	4052487122573
	200-201	HSD250 G 1x200 b40 A2/NBR	1650025201	4052487122634
	210-211	HSD250 G 1x210 b40 A2/NBR	1650025211	4052487122696
300	198-202	HSD300 G 1x200 b40 A2/NBR	1650030201	4052487122795
	208-212	HSD300 G 1x210 b40 A2/NBR	1650030211	4052487122856
	217-221	HSD300 G 1x219 b40 A2/NBR	1650030221	4052487122917
	223-227	HSD300 G 1x225 b40 A2/NBR	1650030231	4052487122979
	248-252	HSD300 G 1x250 b40 A2/NBR	1650030251	4052487123037
400	273-276	HSD400 G 1x273 b40 A2/NBR	1650040271	4052487123099
	277-282	HSD400 G 1x277 b40 A2/NBR	1650040281	4052487123150
	315-321	HSD400 G 1x315 b40 A2/NBR	1650040311	4052487123211
	324-328	HSD400 G 1x324 b40 A2/NBR	1650040321	4052487123273
500	398-402	HSD500 G 1x400 b40 A2/NBR	1650050401	4052487123334
	427-431	HSD500 G 1x429 b40 A2/NBR	1650050431	4052487123396
	448-452	HSD500 G 1x450 b40 A2/NBR	1650050451	4052487123457

A4/NBR

Wall sleeve/ core drilled hole ID (mm)	suitable for medium pipe OD (mm)	Article code	Article number	GTIN
100	32-34	HSD100 1x32 b40 A4/NBR	1650010037	4052487121385
	40-43	HSD100 1x40 b40 A4/NBR	1650010045	4052487121446
	48-51	HSD100 1x48 b40 A4/NBR	1650010053	4052487121507
	60-63.5	HSD100 1x60 b40 A4/NBR	1650010065	4052487121569
125	60-63.5	HSD125 1x60 b40 A4/NBR	1650012065	4052487121620
	75-77	HSD125 1x75 b40 A4/NBR	1650012080	4052487121682
	78-81	HSD125 1x78 b40 A4/NBR	1650012090	4052487121743
150	78-81	HSD150 1x78 b40 A4/NBR	1650015083	4052487121866
	88-92	HSD150 1x88 b40 A4/NBR	1650015093	4052487121927
	110-113	HSD150 1x110 b40 A4/NBR	1650015114	4052487121989
200	110-113	HSD200 1x110 b40 A4/NBR	1650020105	4052487122085
	114-119	HSD200 1x114 b40 A4/NBR	1650020115	4052487122146
	125-128	HSD200 1x125 b40 A4/NBR	1650020125	4052487122207
	133-136	HSD200 1x133 b40 A4/NBR	1650020135	4052487122269
	139-141	HSD200 1x139 b40 A4/NBR	1650020145	4052487122320
	159-163	HSD200 1x159 b40 A4/NBR	1650020155	4052487122382
250	159-163	HSD250 G 1x159 b40 A4/NBR	1650025155	4052487122481
	168-171	HSD250 G 1x168 b40 A4/NBR	1650025165	4052487122542
	177-181	HSD250 G 1x177 b40 A4/NBR	1650025175	4052487122603
	200-201	HSD250 G 1x200 b40 A4/NBR	1650025205	4052487122665
	210-211	HSD250 G 1x210 b40 A4/NBR	1650025215	4052487122726
300	198-202	HSD300 G 1x200 b40 A4/NBR	1650030205	4052487122825
	208-212	HSD300 G 1x210 b40 A4/NBR	1650030215	4052487122887
	217-221	HSD300 G 1x219 b40 A4/NBR	1650030225	4052487122948
	223-227	HSD300 G 1x225 b40 A4/NBR	1650030235	4052487123006
	248-252	HSD300 G 1x250 b40 A4/NBR	1650030255	4052487123068
400	273-276	HSD400 G 1x273 b40 A4/NBR	1650040275	4052487123129
	277-282	HSD400 G 1x277 b40 A4/NBR	1650040285	4052487123181
	315-321	HSD400 G 1x315 b40 A4/NBR	1650040315	4052487123242
	324-328	HSD400 G 1x324 b40 A4/NBR	1650040325	4052487123303
500	398-402	HSD500 G 1x400 b40 A4/NBR	1650050405	4052487123365
	427-431	HSD500 G 1x429 b40 A4/NBR	1650050435	4052487123426
	448-452	HSD500 G 1x450 b40 A4/NBR	1650050455	4052487123488

A2/KTW

Wall sleeve/ core drilled hole ID (mm)	suitable for medium pipe OD (mm)	Article code	Article number	GTIN
100	32-34	HSD100 1x32 b40 A2/KTW	1650010034	4052487121361
	40-43	HSD100 1x40 b40 A2/KTW	1650010042	4052487121422
	48-51	HSD100 1x48 b40 A2/KTW	1650010050	4052487121484
	60-63.5	HSD100 1x60 b40 A2/KTW	1650010062	4052487121545
125	60-63.5	HSD125 1x60 b40 A2/KTW	1650012062	4052487121606
	75-77	HSD125 1x75 b40 A2/KTW	1650012077	4052487121668
	78-81	HSD125 1x78 b40 A2/KTW	1650012087	4052487121729
150	78-81	HSD150 1x78 b40 A2/KTW	1650015080	4052487121842
	88-92	HSD150 1x88 b40 A2/KTW	1650015090	4052487121903
	110-113	HSD150 1x110 b40 A2/KTW	1650015112	4052487121965
200	110-113	HSD200 1x110 b40 A2/KTW	1650020102	4052487122061
	114-119	HSD200 1x114 b40 A2/KTW	1650020112	4052487122122
	125-128	HSD200 1x125 b40 A2/KTW	1650020122	4052487122184
	133-136	HSD200 1x133 b40 A2/KTW	1650020132	4052487122245
	139-141	HSD200 1x139 b40 A2/KTW	1650020142	4052487122306
	159-163	HSD200 1x159 b40 A2/KTW	1650020152	4052487122368
250	159-163	HSD250 G 1x159 b40 A2/KTW	1650025152	4052487122467
	168-171	HSD250 G 1x168 b40 A2/KTW	1650025162	4052487122528
	177-181	HSD250 G 1x177 b40 A2/KTW	1650025172	4052487122580
	200-201	HSD250 G 1x200 b40 A2/KTW	1650025202	4052487122641
	210-211	HSD250 G 1x210 b40 A2/KTW	1650025212	4052487122702
300	198-202	HSD300 G 1x200 b40 A2/KTW	1650030202	4052487122801
	208-212	HSD300 G 1x210 b40 A2/KTW	1650030212	4052487122863
	217-221	HSD300 G 1x219 b40 A2/KTW	1650030222	4052487122924
	223-227	HSD300 G 1x225 b40 A2/KTW	1650030232	4052487122986
	248-252	HSD300 G 1x250 b40 A2/KTW	1650030252	4052487123044
400	273-276	HSD400 G 1x273 b40 A2/KTW	1650040272	4052487123105
	277-282	HSD400 G 1x277 b40 A2/KTW	1650040282	4052487123167
	315-321	HSD400 G 1x315 b40 A2/KTW	1650040312	4052487123228
	324-328	HSD400 G 1x324 b40 A2/KTW	1650040322	4052487123280
500	398-402	HSD500 G 1x400 b40 A2/KTW	1650050402	4052487123341
	427-431	HSD500 G 1x429 b40 A2/KTW	1650050432	4052487123402
	448-452	HSD500 G 1x450 b40 A2/KTW	1650050452	4052487123464

A4/KTW

Wall sleeve/ core drilled hole ID (mm)	suitable for medium pipe OD (mm)	Article code	Article number	GTIN
100	32-34	HSD100 1x32 b40 A4/KTW	1650010038	4052487121392
	40-43	HSD100 1x40 b40 A4/KTW	1650010046	4052487121453
	48-51	HSD100 1x48 b40 A4/KTW	1650010054	4052487121514
	60-63.5	HSD100 1x60 b40 A4/KTW	1650010066	4052487121576
125	60-63.5	HSD125 1x60 b40 A4/KTW	1650012066	4052487121637
	75-77	HSD125 1x75 b40 A4/KTW	1650012081	4052487121699
	78-81	HSD125 1x78 b40 A4/KTW	1650012091	4052487121750
150	78-81	HSD150 1x78 b40 A4/KTW	1650015084	4052487121873
	88-92	HSD150 1x88 b40 A4/KTW	1650015094	4052487121934
	110-113	HSD150 1x110 b40 A4/KTW	1650015115	4052487121996
200	110-113	HSD200 1x110 b40 A4/KTW	1650020106	4052487122092
	114-119	HSD200 1x114 b40 A4/KTW	1650020116	4052487122153
	125-128	HSD200 1x125 b40 A4/KTW	1650020126	4052487122214
	133-136	HSD200 1x133 b40 A4/KTW	1650020136	4052487122276
	139-141	HSD200 1x139 b40 A4/KTW	1650020146	4052487122337
	159-163	HSD200 1x159 b40 A4/KTW	1650020156	4052487122399
250	159-163	HSD250 G 1x159 b40 A4/KTW	1650025156	4052487122498
	168-171	HSD250 G 1x168 b40 A4/KTW	1650025166	4052487122559
	177-181	HSD250 G 1x177 b40 A4/KTW	1650025176	4052487122610
	200-201	HSD250 G 1x200 b40 A4/KTW	1650025206	4052487122672
	210-211	HSD250 G 1x210 b40 A4/KTW	1650025216	4052487122733
300	198-202	HSD300 G 1x200 b40 A4/KTW	1650030206	4052487122832
	208-212	HSD300 G 1x210 b40 A4/KTW	1650030216	4052487122894
	217-221	HSD300 G 1x219 b40 A4/KTW	1650030226	4052487122955
	223-227	HSD300 G 1x225 b40 A4/KTW	1650030236	4052487123013
	248-252	HSD300 G 1x250 b40 A4/KTW	1650030256	4052487123075
400	273-276	HSD400 G 1x273 b40 A4/KTW	1650040276	4052487123136
	277-282	HSD400 G 1x277 b40 A4/KTW	1650040286	4052487123198
	315-321	HSD400 G 1x315 b40 A4/KTW	1650040316	4052487123259
	324-328	HSD400 G 1x324 b40 A4/KTW	1650040326	4052487123310
500	398-402	HSD500 G 1x400 b40 A4/KTW	1650050406	4052487123372
	427-431	HSD500 G 1x429 b40 A4/KTW	1650050436	4052487123433
	448-452	HSD500 G 1x450 b40 A4/KTW	1650050456	4052487123495

For pipes

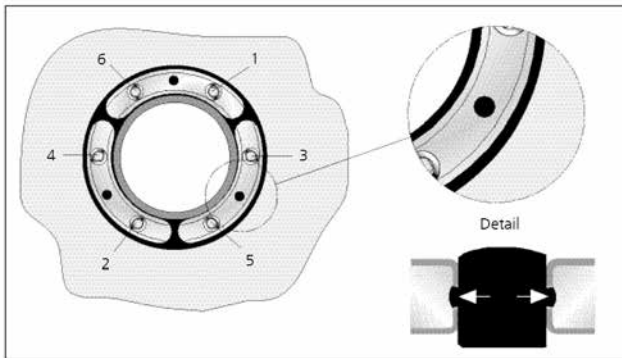

Detailed view - HSD, inspection opening and tightening sequence of the screws



Built-in HSD b40

Standard press seal

sealing width 80 mm



HSD b80

For sealing new or already installed pipes in core drill holes or wall sleeves. Available for delivery for all standard pipe sizes.

USP

- Visual and physical installation control through integrated inspection window

Tightness

- gastight and watertight
- radon-proof



Dimensions

- Sealing width: 80 mm

Wall sleeve/ core drilled hole ID (mm)	suitable for medium pipe OD (mm)	Article code	Article number	GTIN
100	32-34	HSD100 1x32 b80 A2/EPDM	1600100321	4052487040327
	40-43	HSD100 1x40 b80 A2/EPDM	1600100401	4052487040341
	48-51	HSD100 1x48 b80 A2/EPDM	1600100481	4052487040365
	60-63.5	HSD100 1x60 b80 A2/EPDM	1600100601	4052487040389
125	60-63.5	HSD125 1x60 b80 A2/EPDM	1600200601	4052487040709
	75-77	HSD125 1x75 b80 A2/EPDM	1600200751	4052487040723
	78-81	HSD125 1x78 b80 A2/EPDM	1600200781	4052487040747
150	78-81	HSD150 1x78 b80 A2/EPDM	1600300781	4052487040907
	88-92	HSD150 1x88 b80 A2/EPDM	1600300881	4052487040921
	110-113	HSD150 1x110 b80 A2/EPDM	1600300111	4052487040839
200	110-113	HSD200 1x110 b80 A2/EPDM	1600400111	4052487040976
	114-119	HSD200 1x114 b80 A2/EPDM	1600400115	4052487041010
	125-128	HSD200 1x125 b80 A2/EPDM	1600400126	4052487041034
	133-136	HSD200 1x133 b80 A2/EPDM	1600400134	4052487041096
	139-141	HSD200 1x139 b80 A2/EPDM	1600400128	4052487041058
	159-163	HSD200 1x159 b80 A2/EPDM	1600400127	4052487041041
250	159-163	HSD250 1x159 b80 A2/EPDM	1600500203	4052487041317
	168-171	HSD250 1x168 b80 A2/EPDM	1600500169	4052487041263
	177-181	HSD250 1x177 b80 A2/EPDM	1600500202	4052487041300
	200-201	HSD250 1x200 b80 A2/EPDM	1600500201	4052487041294
	210-211	HSD250 1x210 b80 A2/EPDM	1600500211	4052487041331
300	198-202	HSD300 1x200 b80 A2/EPDM	1600600201	4052487041430
	208-212	HSD300 1x210 b80 A2/EPDM	1600600211	4052487041454
	217-221	HSD300 1x219 b80 A2/EPDM	1600600220	4052487041478
	223-227	HSD300 1x225 b80 A2/EPDM	1600600253	4052487041508
	248-252	HSD300 1x250 b80 A2/EPDM	1600600254	4052487041515
400	273-276	HSD400 1x273 b80 A2/EPDM	1600700274	4052487041560
	277-282	HSD400 1x277 b80 A2/EPDM	1600700326	4052487041638

For pipes

Wall sleeve/ core drilled hole ID (mm)	suitable for medium pipe OD (mm)	Article code	Article number	GTIN
400	315-321	HSD400 1x315 b80 A2/EPDM	1600700316	4052487041607
	324-328	HSD400 1x324 b80 A2/EPDM	1600700325	4052487041621
500	398-402	HSD500 1x400 b80 A2/EPDM	1600800401	4052487041690
	427-431	HSD500 1x429 b80 A2/EPDM	1600800430	4052487041713
	448-452	HSD500 1x450 b80 A2/EPDM	1600800451	4052487041737



HSD b80 cross section



HSD500 1x450 b80 A2/EPDM55

Standard press seal

sealing width 20 mm

HSD b20



For sealing new or already installed pipes in core drill holes or wall sleeves. Available for delivery for all standard pipe sizes.

USP

- Visual and physical installation control through integrated inspection window

Dimensions

- Sealing width: 20 mm

Tightness

- gastight and watertight

A2/EPDM

Wall sleeve/ core drilled hole ID (mm)	suitable for medium pipe OD (mm)	Article code	Article number	GTIN
100	32-34	HSD100 1x32 b20 A2/EPDM	1650310032	4052487125109
	40-43	HSD100 1x40 b20 A2/EPDM	1650310040	4052487125161
	48-51	HSD100 1x48 b20 A2/EPDM	1650310048	4052487125222
	60-63.5	HSD100 1x60 b20 A2/EPDM	1650310060	4052487125284
125	60-63.5	HSD125 1x60 b20 A2/EPDM	1650312060	4052487125345
	75-77	HSD125 1x75 b20 A2/EPDM	1650312075	4052487125406
	78-81	HSD125 1x78 b20 A2/EPDM	1650312085	4052487125468
150	78-81	HSD150 1x78 b20 A2/EPDM	1650315078	4052487125529
	88-92	HSD150 1x88 b20 A2/EPDM	1650315088	4052487125581
	110-113	HSD150 1x110 b20 A2/EPDM	1650315110	4052487125642
200	110-113	HSD200 1x110 b20 A2/EPDM	1650320100	4052487125703
	114-119	HSD200 1x114 b20 A2/EPDM	1650320110	4052487125765
	125-128	HSD200 1x125 b20 A2/EPDM	1650320120	4052487125826
	133-136	HSD200 1x133 b20 A2/EPDM	1650320130	4052487125888
	139-141	HSD200 1x139 b20 A2/EPDM	1650320140	4052487125949
	159-163	HSD200 1x159 b20 A2/EPDM	1650320150	4052487126007

A4/EPDM

Wall sleeve/ core drilled hole ID (mm)	suitable for medium pipe OD (mm)	Article code	Article number	GTIN
100	32-34	HSD100 1x32 b20 A4/EPDM	1650310036	4052487125130
	40-43	HSD100 1x40 b20 A4/EPDM	1650310044	4052487125192
	48-51	HSD100 1x48 b20 A4/EPDM	1650310052	4052487125253
	60-63.5	HSD100 1x60 b20 A4/EPDM	1650310064	4052487125314
125	60-63.5	HSD125 1x60 b20 A4/EPDM	1650312064	4052487125376
	75-77	HSD125 1x75 b20 A4/EPDM	1650312079	4052487125437
	78-81	HSD125 1x78 b20 A4/EPDM	1650312089	4052487125499
150	78-81	HSD150 1x78 b20 A4/EPDM	1650315082	4052487125550
	88-92	HSD150 1x88 b20 A4/EPDM	1650315092	4052487125611
	110-113	HSD150 1x110 b20 A4/EPDM	1650315113	4052487125673
200	110-113	HSD200 1x110 b20 A4/EPDM	1650320104	4052487125734
	114-119	HSD200 1x114 b20 A4/EPDM	1650320114	4052487125796
	125-128	HSD200 1x125 b20 A4/EPDM	1650320124	4052487125857
	133-136	HSD200 1x133 b20 A4/EPDM	1650320134	4052487125918
	139-141	HSD200 1x139 b20 A4/EPDM	1650320144	4052487125970
	159-163	HSD200 1x159 b20 A4/EPDM	1650320154	4052487126038

A2/KTW

Wall sleeve/ core drilled hole ID (mm)	suitable for medium pipe OD (mm)	Article code	Article number	GTIN
100	32-34	HSD100 1x32 b20 A2/KTW	1650310034	4052487125123
	40-43	HSD100 1x40 b20 A2/KTW	1650310042	4052487125185
	48-51	HSD100 1x48 b20 A2/KTW	1650310050	4052487125246
	60-63.5	HSD100 1x60 b20 A2/KTW	1650310062	4052487125307
125	60-63.5	HSD125 1x60 b20 A2/KTW	1650312062	4052487125369
	75-77	HSD125 1x75 b20 A2/KTW	1650312077	4052487125420
	78-81	HSD125 1x78 b20 A2/KTW	1650312087	4052487125482
150	78-81	HSD150 1x78 b20 A2/KTW	1650315080	4052487125543
	88-92	HSD150 1x88 b20 A2/KTW	1650315090	4052487125604
	110-113	HSD150 1x110 b20 A2/KTW	1650315112	4052487125666
200	110-113	HSD200 1x110 b20 A2/KTW	1650320102	4052487125727
	114-119	HSD200 1x114 b20 A2/KTW	1650320112	4052487125789
	125-128	HSD200 1x125 b20 A2/KTW	1650320122	4052487125840
	133-136	HSD200 1x133 b20 A2/KTW	1650320132	4052487125901
	139-141	HSD200 1x139 b20 A2/KTW	1650320142	4052487125963
	159-163	HSD200 1x159 b20 A2/KTW	1650320152	4052487126021

A4/KTW

Wall sleeve/ core drilled hole ID (mm)	suitable for medium pipe OD (mm)	Article code	Article number	GTIN
100	32-34	HSD100 1x32 b20 A4/KTW	1650310038	4052487125154
	40-43	HSD100 1x40 b20 A4/KTW	1650310046	4052487125215
	48-51	HSD100 1x48 b20 A4/KTW	1650310054	4052487125277
	60-63.5	HSD100 1x60 b20 A4/KTW	1650310066	4052487125338
125	60-63.5	HSD125 1x60 b20 A4/KTW	1650312066	4052487125390
	75-77	HSD125 1x75 b20 A4/KTW	1650312081	4052487125451
	78-81	HSD125 1x78 b20 A4/KTW	1650312091	4052487125512
150	78-81	HSD150 1x78 b20 A4/KTW	1650315084	4052487125574
	88-92	HSD150 1x88 b20 A4/KTW	1650315094	4052487125635
	110-113	HSD150 1x110 b20 A4/KTW	1650315115	4052487125697
200	110-113	HSD200 1x110 b20 A4/KTW	1650320106	4052487125758
	114-119	HSD200 1x114 b20 A4/KTW	1650320116	4052487125819
	125-128	HSD200 1x125 b20 A4/KTW	1650320126	4052487125871
	133-136	HSD200 1x133 b20 A4/KTW	1650320136	4052487125932
	139-141	HSD200 1x139 b20 A4/KTW	1650320146	4052487125994
	159-163	HSD200 1x159 b20 A4/KTW	1650320156	4052487126052

03 Press seals

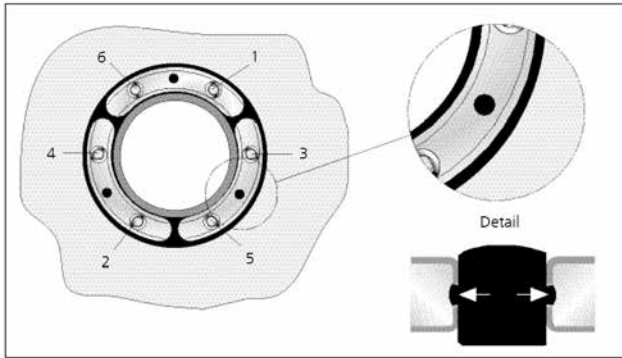

Detailed view - HSD, inspection opening and tightening sequence of the screws



HSD200 1x159 b20 A2/EPDM55 "shaft seal"



HSD125 1x75 b20 A2/EPDM55 empty conduit connection

Standard press seal

with powder coating

HSD C b40

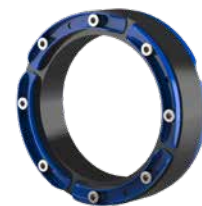

For sealing new or already installed pipes in galvanised wall sleeves. Available for delivery for all standard pipe sizes.

USP

- Visual and physical installation control through integrated inspection window
- optimised corrosion protection when used in combination with galvanised components

Dimensions

- Sealing width: 40 mm

Tightness

- gastight and watertight
- radon-proof



powder coated

Wall sleeve/ core drilled hole ID (mm)	suitable for medium pipe OD (mm)	Article code	Article number	GTIN
100	32-34	HSD100 c 1x32 b40 A2/EPDM	1610100320	4052487042123
	40-43	HSD100 c 1x40 b40 A2/EPDM	1610100400	4052487042130
	48-51	HSD100 c 1x48 b40 A2/EPDM	1610100480	4052487042147
	60-63.5	HSD100 c 1x60 b40 A2/EPDM	1610100600	4052487042154
125	60-63.5	HSD125 c 1x60 b40 A2/EPDM	1610200600	4052487042284
	75-77	HSD125 c 1x75 b40 A2/EPDM	1610200750	4052487042291
	78-81	HSD125 c 1x78 b40 A2/EPDM	1610200780	4052487042307
150	78-81	HSD150 c 1x78 b40 A2/EPDM	1610300780	4052487042369
	88-92	HSD150 c 1x88 b40 A2/EPDM	1610300880	4052487042376
	110-113	HSD150 c 1x110 b40 A2/EPDM	1610300110	4052487042352
200	110-113	HSD200 c 1x110 b40 A2/EPDM	1610400110	4052487042390
	114-119	HSD200 c 1x114 b40 A2/EPDM	1610400114	4052487042406
	125-128	HSD200 c 1x125 b40 A2/EPDM	1610400125	4052487042413
	133-136	HSD200 c 1x133 b40 A2/EPDM	1610400133	4052487042420
	139-141	HSD200 c 1x139 b40 A2/EPDM	1610400139	4052487042437
	159-163	HSD200 c 1x159 b40 A2/EPDM	1610400159	4052487042444

split, powder coated

Wall sleeve/ core drilled hole ID (mm)	suitable for medium pipe OD (mm)	Article code	Article number	GTIN
250	159-163	HSD250 GC 1x159 b40 A2/EPDM	1610500159	4052487042475
	168-171	HSD250 GC 1x168 b40 A2/EPDM	1610500168	4052487042482
	177-181	HSD250 GC 1x177 b40 A2/EPDM	1610500177	4052487042499
	200-201	HSD250 GC 1x200 b40 A2/EPDM	1610500200	4052487042505
	210-211	HSD250 GC 1x210 b40 A2/EPDM	1610500210	4052487042512
300	198-202	HSD300 GC 1x200 b40 A2/EPDM	1610600200	4052487042529
	208-212	HSD300 GC 1x210 b40 A2/EPDM	1610600210	4052487042536
	217-221	HSD300 GC 1x219 b40 A2/EPDM	1610600219	4052487042543
	223-227	HSD300 GC 1x225 b40 A2/EPDM	1610600225	4052487042550
	248-252	HSD300 GC 1x250 b40 A2/EPDM	1610600250	4052487042567
400	273-276	HSD400 GC 1x273 b40 A2/EPDM	1610700273	4052487042574
	277-282	HSD400 GC 1x277 b40 A2/EPDM	1610700277	4052487042581
	315-321	HSD400 GC 1x315 b40 A2/EPDM	1610700315	4052487042598
	324-328	HSD400 GC 1x324 b40 A2/EPDM	1610700324	4052487042604
500	398-402	HSD500 GC 1x400 b40 A2/EPDM	1610800400	4052487042611
	427-431	HSD500 GC 1x429 b40 A2/EPDM	1610800429	4052487042628
	448-452	HSD500 GC 1x450 b40 A2/EPDM	1610800450	4052487042635

Other variants on request.



HSD200 C 1x159 b40 A2/EPDM5 5 in galvanised fixed/loose flange



HSD200 C 1x159 b40 A2/EPDM5 5 in galvanised fixed/loose flange



HSD150 C 1x110 b40 A2/EPDM55 in galvanised fixed/loose flange

Standard press seal

HSD100 RW 1x25/32/40+3x6-18 b40 A2/EPDM



For sealing new or already installed pipes/cables in core drill holes or wall sleeves, specially designed for rainwater utilisation systems.

USP

- Visual and physical installation control through integrated inspection window
- integrated segmented-ring technology for individual adjustment to cable diameters on site

- For core drills/wall sleeves Ø: 100 mm
- For 4 cables/pipes of which 3 x Ø 6-18 mm and 1 x Ø 10, 25, 32 or 40 mm



Tightness

- gastight and watertight
- radon-proof

Dimensions

- Sealing width: 40 mm

Wall sleeve/ core drilled hole ID (mm)	Number of cables/ medium overall	Number of cables/ medium	suitable for medium pipe OD (mm)	Article code	Packing unit	Article number	GTIN
100	4	1	10/25/32/40	HSD100 RW 1x25/32/40+3x6-18 b40 A2/EPDM	1	3030300059	4052487112499
		3	6-18				4052487223720
		1	10/25/32/40		5		
		3	6-18				



Built-in HSD100 RW

Accessories

Figure	Item	Article code	Article number	GTIN
	Adapter ring for HSD 100	HSD ADR 100/104	3030300051	4052487040556
		HSD ADR 100/110	3030300052	4052487223690
		HSD ADR 100/117	3030300053	4052487172127

Standard press seal

for building connections



HSD100 EW 1x24-44+4x7-12 b40 A2/EPDM

For sealing a water pipe or a power cable and communication cables in core drill holes or wall sleeves.

USP

- Visual and physical installation control through integrated inspection window
- integrated segmented-ring technology for individual adjustment to cable diameters on site

- For core drills/wall sleeves Ø: 100 mm
- For 5 cables/pipes of which 4 x Ø 7-12 mm and 1 x Ø 24-44 mm



Tightness

- gastight and watertight
- radon-proof

Dimensions

- Sealing width: 40 mm

Wall sleeve/ core drilled hole ID (mm)	Number of cables/ medium overall	Number of cables/ medium	suitable for medium pipe OD (mm)	Article code	Packing unit	Article number	GTIN
100	5	1	24-44	HSD100 EW 1x24-44+4x7-12 b40 A2/EPDM	1	3030300054	4052487126250
		4	7-12				4052487221566
		1	24-44		15		
		4	7-12				



Built-in HSD100 EW

Sealing set

for corrugated cable ducts and pipes



WRD

For sealing corrugated cable ducts and pipes. The patented clip rings inserted into the corrugated profile prevent deformation and damage to the corrugated pipe and at the same time ensure equal pressure on the press seal. The supplied insulation ring is used to centre the corrugated pipe on the inside of the building and ensures a clean wall finish.

USP

- Visual and physical installation control through integrated inspection window
- patented clip ring technology ensures equal pressure distribution and prevents deformation

- Stainless steel clip rings
- 1 piece of Insulation ring, split

Dimensions

- Sealing width: 40, 60 or 80 mm (depending on corrugated pipe)



Scope of delivery

- 1 piece of standard press seal HSD

Tightness

- gastight and watertight
- radon-proof

Wall sleeve/ core drilled hole ID (mm)	Nominal width (mm)	Manufacturer	Type	Article code	Article number	GTIN
100	63	Fränkische Rohrwerke	KABUFLEX	WRD100 1x63 b40 A2/ EPDM	1610100063	4052487042116
150	75	Fränkische Rohrwerke	KABUFLEX	WRD150 1x75 b40 A2/ EPDM	1610150075	4052487042208
	90	Fränkische Rohrwerke	KABUFLEX	WRD150 1x90 b40 A2/ EPDM	1610150090	4052487042215
	110	Fränkische Rohrwerke	KABUFLEX	WRD150 1x110 b40 A2/EPDM	1610150110	4052487042222
200	110	Fränkische Rohrwerke	KABUFLEX	WRD200 1x110 b40 A2/EPDM	1610200110	4052487042239
	125	Fränkische Rohrwerke	KABUFLEX	WRD200 1x125 b40 A2/EPDM	1610200125	4052487042253
	160	Fränkische Rohrwerke	KABUFLEX	WRD200 1x160 b80 A2/EPDM	1610200160	4052487042277
250	160	Fränkische Rohrwerke	KABUFLEX	WRD250 1x160 b80 A2/EPDM	1610250160	4052487042314
	200	Fränkische Rohrwerke	KABUFLEX	WRD250 1x200 b80 A2/EPDM	1610250300	4052487181907

GTIN and article number depend on the type of pipe and pipe manufacturer.
Additional sizes on request.

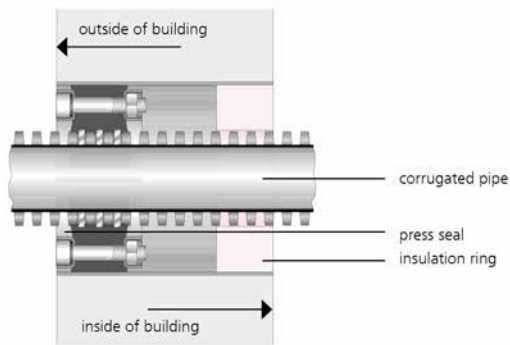

Sectional drawing: Positioning in the bore

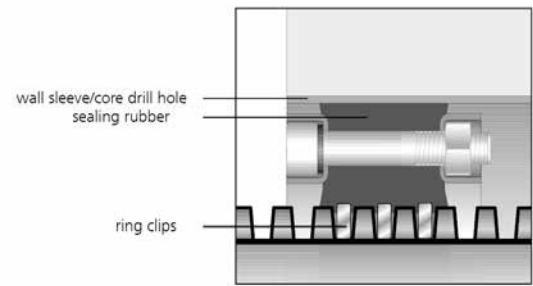

Detailed view: Clip ring/seal



WRD200 1x125 A2/EPDM55 e.g. Kabuflex/Fränkische



Accessories

Figure	Item	Article code	Article number	GTIN
	Core drill hole sealant for coating drill hole walls	KBV 2K	354040001	4052487168533

04 Wastewater entries

Wastewater entries are a critical connection between the building structure and the drainage system. They must reliably prevent the ingress of water and gas while ensuring a durable and secure connection to wastewater pipes. Precise planning and high-quality sealing solutions are essential to protect the building envelope and maintain long-term functionality.

Hauff-Technik wastewater entries are engineered for maximum safety and durability. Designed for use in new buildings as well as retrofit applications, we provide reliable and efficient sealing solutions for a wide range of pipe materials and diameters.

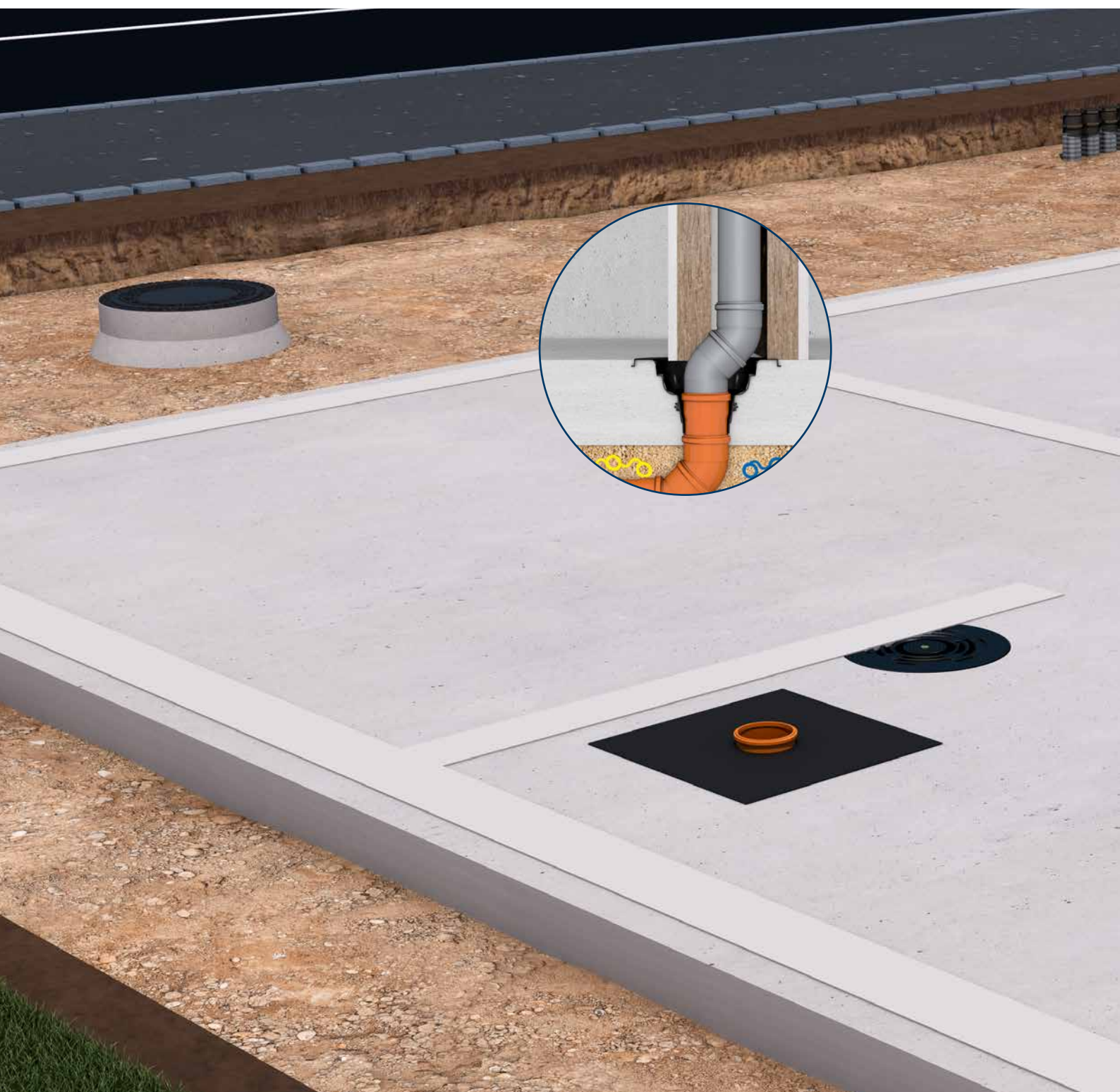

Whether for concrete walls, floor slabs or existing structures, Hauff-Technik offers a wide portfolio of wastewater entry systems. Our solutions enable fast, clean installation and provide long-lasting protection against moisture ingress, odors and structural damage.

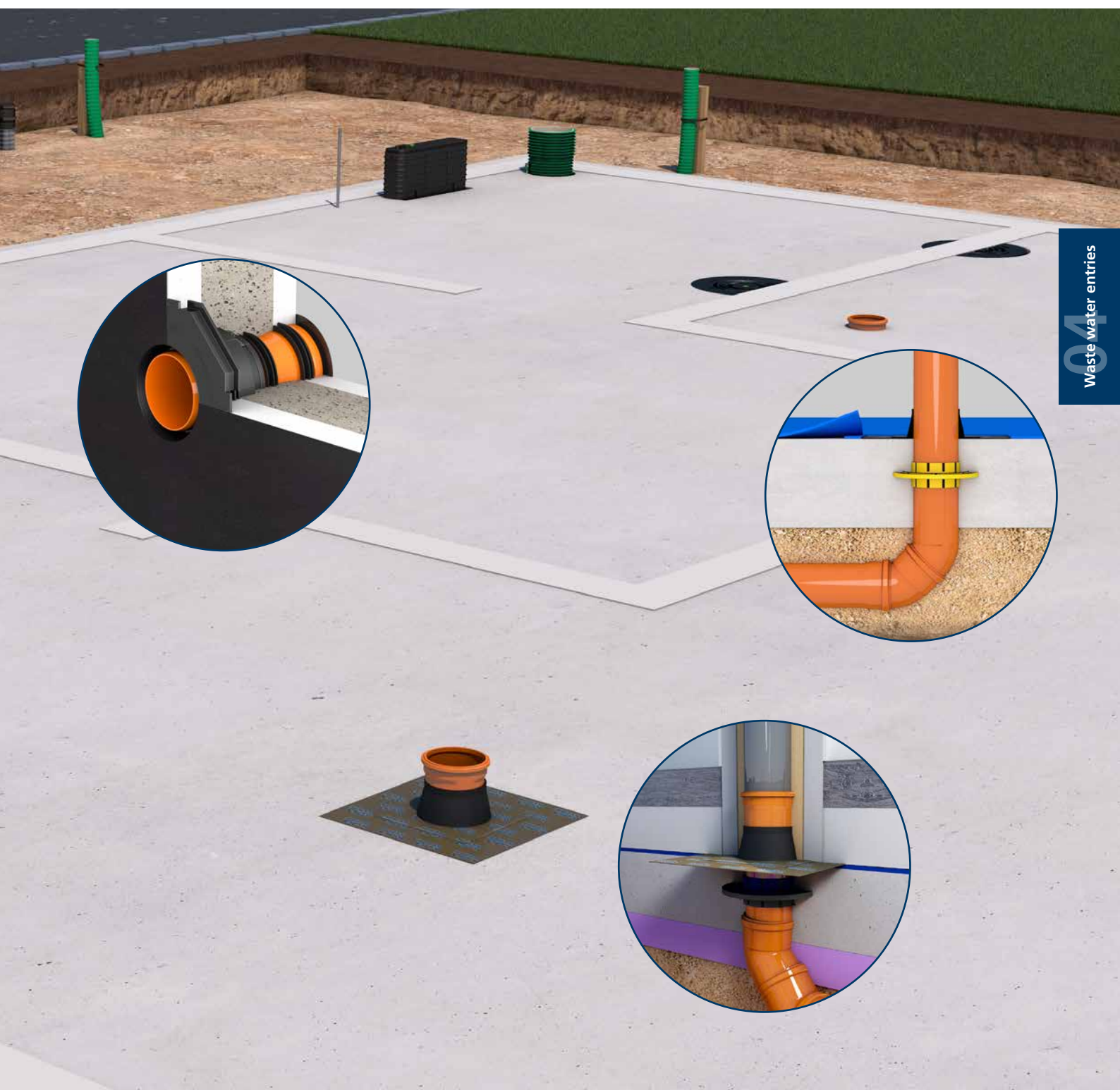

Waste water entries
04

Tundish

AT110



Tundish with integrated step protection for setting in floor slab concrete for perfect sealing to the underground sewer pipe. Gastight and watertight connection to the floor slab using integrated 3-ribbed seal. Gastight and watertight connection to the KG pipe using TPE-seal. To compensate an offset (after concreting) between downpipe and floor drain in any direction.

USP

- with axial tolerance compensation
- easy integration of the vapour barrier using the adhesive flange
- non-trip installation according to DGUV 38 §12a thanks to step safe cover
- with integrated spirit level for positioning the tundish

Scope of delivery

- 1 piece of offset funnel

- 1 piece of step protection with integrated level
- 1 piece of clamping strap

Dimensions

- Offset diameter: 250 mm
- Flange all around: 50mm
- for underground sewage pipe DN 110

Tightness

- gastight and watertight
- radon-proof



suitable for medium pipe OD (mm)	Article code	Packing unit	Article number	GTIN
110	AT110	1	827001601	4052487171663
		8		4052487224314
		32		4052487224321

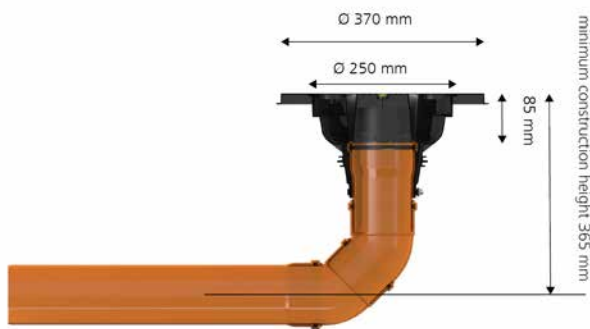

Dimensioning connection funnel AT110



AT110 installed in the floor slab - slip-resistant and trip-free during the construction phase



AT110 installed in the floor slab, absolutely gas- and watertight, with the option of tolerance compensation and connection of a vapor barrier

Wall collar

KG-FIX

KGF



Water barrier flange for pressure-tight connection of waste water pipes in floor slabs.

USP

- quick, tool-less installation
- contains recycled polymer
- high form stability through combination of materials

Dimensions

- Water barrier flange all around: 50mm
- Socket length: 60mm

Tightness

- pressure-rated up to 5,0 bar
- radon-proof



Wall collar OD (mm)	suitable for medium pipe OD (mm)	Article code	Packing unit	Article number	GTIN
212	110	KGF110	1	3030537182	4052487244879
			15		4052487244886
227	125	KGF125	1	3030537197	4052487244787
			5		4052487244794
262	160	KGF160	1	3030537198	4052487244817
			5		4052487244824



Waste water entries

Wall collar

HMK

Water barrier flange for watertight connection of pipelines in floor slabs.



Scope of delivery

- 1 piece of water barrier flange
- 2 pieces of clamping straps

Tightness

- gastight and watertight
- radon-proof



Diameter range (mm)	Wall collar OD (mm)	suitable for medium pipe OD (mm)	Article code	Packing unit	Article number	GTIN
120-130	213	125	HMK125	1	5060150801	4052487233286
				5		4052487233804
135-148	228	140	HMK140	1	5060150802	4052487233279
				5		4052487233811
195-210	288	200	HMK200	1	5060150804	4052487233262
				5		4052487233828

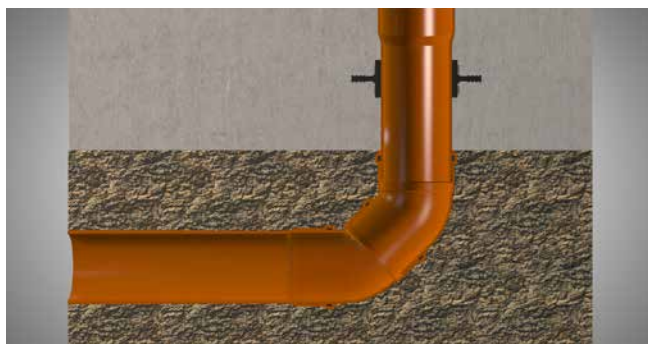

HMK installed in floor slab to seal a wastewater pipe

Accessories

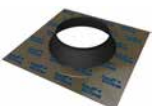
Figure	Number of cables/medium	Size (mm)	Article code	Article number	GTIN
	1	320 x 320	HFM 1x100-110¹⁾	3030370212	4052487228053
	1	320 x 320	HFM 1x125-135	3030370213	4052487228060
	1	350 x 350	HFM 1x150-165	3030370214	4052487228077
	1	420 x 420	HFM 1x200-220	3030370215	4052487228084

¹⁾ e.g. suitable for ESG100 FUBO BHPXL10m

Universal wall entry

without edges



UDM

Optimised flow through the wall - prevents blockages and backflow in the drainage system. The special design allows standard KG (2000) pipes to be adapted to the wall thickness and converted into a wall penetration directly on site. Can also be supplied to the required wall thickness.

USP

- with integrated flange to attach waterproofing material
- no change in flow direction
- pressure-tight after concreting

Scope of delivery

- Scope of delivery without KG pipe: rubber sleeve, clamping band, sleeve cover with flange and blind cover for knock-in, lamella plug (pre-assembled)

- Scope of delivery with KG pipe: rubber sleeve, clamping strap, sleeve cover with flange and blind cover for knock-in, lamella plug and KG (2000) pipe (pre-assembled ready for installation)



Dimensions

- DN 110: minimum wall thickness 200 mm
- DN 150: minimum wall thickness 240 mm



Tightness

- gastight and watertight
- radon-proof



Universal wall entry without KG-pipe

Figure	Nominal diameter of KG pipe	suitable for medium pipe OD (mm)	Article code	Article number	GTIN
	DN 100	110	UDM100	3030300188	4052487215527
	DN 150	160	UDM150	3030300204	4052487215688

Universal wall entry with KG-pipe

Figure	Nominal diameter of KG pipe	suitable for medium pipe OD (mm)	Wall thickness (mm)	Article code	Article number	GTIN
	DN 100	110	200	UDM100/200 KG	3030300189	4052487215534
			240	UDM100/240 KG	3030300191	4052487215558
			250	UDM100/250 KG	3030300193	4052487215572
			300	UDM100/300 KG	3030300195	4052487215596
			365	UDM100/365 KG	3030300198	4052487215626
			400	UDM100/400 KG	3030300200	4052487215640
			500	UDM100/500 KG	3030300202	4052487215664
	DN 150	160	240	UDM150/240 KG	3030300205	4052487215695
			250	UDM150/250 KG	3030300207	4052487215718
			300	UDM150/300 KG	3030300210	4052487215749
			365	UDM150/365 KG	3030300213	4052487215770
			400	UDM150/400 KG	3030300215	4052487215794
			500	UDM150/500 KG	3030300217	4052487215817

Universal wall entry with KG2000-pipe

Figure	Nominal diameter of KG pipe	suitable for medium pipe OD (mm)	Wall thickness (mm)	Article code	Article number	GTIN
	DN 100	110	200	UDM100/200 KG2000	3030300190	4052487215541
			240	UDM100/240 KG2000	3030300192	4052487215565
			250	UDM100/250 KG2000	3030300194	4052487215589
			300	UDM100/300 KG2000	3030300196	4052487215602
			365	UDM100/365 KG2000	3030300199	4052487215633
			400	UDM100/400 KG2000	3030300201	4052487215657
			500	UDM100/500 KG2000	3030300203	4052487215671
	DN 150	160	240	UDM150/240 KG2000	3030300206	4052487215701
			250	UDM150/250 KG2000	3030300208	4052487215725
			300	UDM150/300 KG2000	3030300211	4052487215756
			365	UDM150/365 KG2000	3030300214	4052487215787
			400	UDM150/400 KG2000	3030300216	4052487215800
			500	UDM150/500 KG2000	3030300218	4052487215824

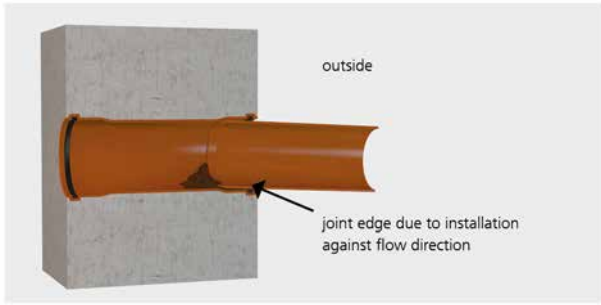

With conventional wall ducts in double push-in socket design, the "flow direction" is interrupted by inserting the KG pipe spigot end on the outside of the building. This leads to a "butt joint" in the event of slight subsidence, which cannot be completely ruled out in the working area. The consequence: Deposits form on the edge, which can lead to "clogging" of the

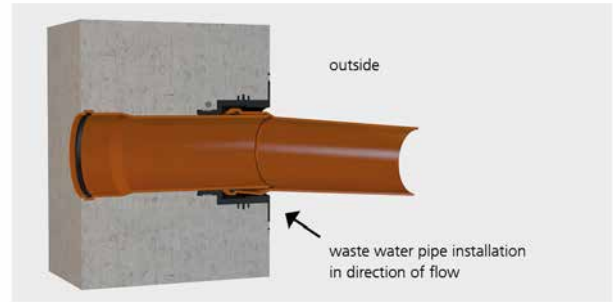

Due to the design of the UDM, there is no interruption of the "flow direction". If slight settling occurs, which cannot be ruled out in the area of the working chamber, there is no "impact edge". As a result, no deposits can form and the function of the drain is not impaired.

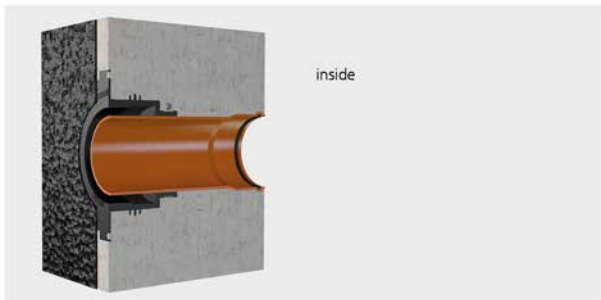

The integrated preparation flange makes it easy to prepare surface waterproofing in accordance with DIN 18533 up to load case W2.1-E. It is therefore not necessary to prepare an elaborate fillet.

Universal wall entry

without edges for installation in double walls/element walls



UDME

Optimised flow through the wall - prevents blockages and backflow in the drainage system. Three 3-ribbed seals for sealing in double element walls.

USP

- with integrated flange to attach waterproofing material
- no change in flow direction
- pressure-tight after concreting

Scope of delivery

- 1 piece of rubber sleeve with integrated 3-ribbed seal
- 1 piece of clamping strap
- 1 piece of sleeve cover with flange and blind cover for knock in
- 2 additional 3-ribbed seals

- 1 piece of lamella plugs
- 1 piece of KG (2000) pipe (pre-mounted ready for installation)



Dimensions

- DN 110: minimum wall thickness 240 mm
- DN 150: minimum wall thickness 300 mm

Tightness

- gastight and watertight
- radon-proof

Universal wall entry for double walls/element walls with KG-pipe

Figure	Nominal diameter of KG pipe	suitable for medium pipe OD (mm)	Wall thickness (mm)	Article code	Article number	GTIN
	DN 100	110	240	UDME100/240 KG	3030300221	4052487215855
			250	UDME100/250 KG	3030300223	4052487215879
			300	UDME100/300 KG	3030300225	4052487215893
			365	UDME100/365 KG	3030300228	4052487215923
			400	UDME100/400 KG	3030300230	4052487215947
	DN 150	160	300	UDME150/300 KG	3030300237	4052487216029
			365	UDME150/365 KG	3030300240	4052487216050
			400	UDME150/400 KG	3030300242	4052487216074

Universal wall entry for double walls/element walls with KG2000-pipe

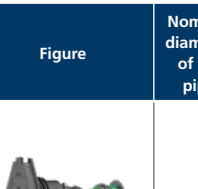
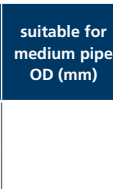
Figure	Nominal diameter of KG pipe	suitable for medium pipe OD (mm)	Wall thickness (mm)	Article code	Article number	GTIN
	DN 100	110	240	UDME100/240 KG2000	3030300222	4052487215862
			250	UDME100/250 KG2000	3030300224	4052487215886
			300	UDME100/300 KG2000	3030300227	4052487215916
			365	UDME100/365 KG2000	3030300229	4052487215930
			400	UDME100/400 KG2000	3030300231	4052487215954
	DN 150	160	300	UDME150/300 KG2000	3030300238	4052487216036
			365	UDME150/365 KG2000	3030300241	4052487216067
			400	UDME150/400 KG2000	3030300243	4052487216081



Practical picture of UDM/UDME in concreted wall



Practical image of UDM/UDME installed with PMBC coating and connected KG pipe

Compensating pipe seal

with segmented rings



ADM

For fixing in front of core drills, openings or wall sleeves or in front of cut-outs in sheet metal housings. The waterproofing of the wall can easily be integrated due to the design of the product. The same product also seals the incoming pipe.

USP

- compensation of radial and axial movements
- segmented-ring technology for adjustment to pipe diameters on site

Scope of delivery

- Fixing elements including sealing ring

Dimensions

- Flang all around: 30mm
- Outer diameter ADM150: 290 mm
- Outer diameter ADM200: 340 mm

Tightness

- gastight and watertight

suitable for medium pipe OD (mm)	Wall sleeve/ core drilled hole ID (mm)	Article code	Article number	GTIN
75/90/110	150	ADM150 75/90/110	1400060150	4052487127530
90/110/125/140/160	200	ADM200 90/110/125/140/160	1400061200	4052487126526



Attachment duct collar ADM200 1x90/110/125/140/160



ADM attachment duct collar segment sections

Accessories

Figure	Item	Article code	Article number	GTIN
	Sealant	Hybrid 7057Z	3030537533	4052487248617

Earthings

HEA earthing connections are available for delivery as entries or earthing fixed points in various designs to meet prevailing requirements. Both solutions for installation in concrete walls flush with shuttering and solutions for retrofitting in drill holes are available. Hauff-Technik offers an insulated earthing entry specifically for station construction.

The earthing connections, which are manufactured in stainless steel to the highest quality standards, maintain their function throughout their service life. They are used for protective earthing, functional earthing, operational earthing and lightning protection earthing, for example.

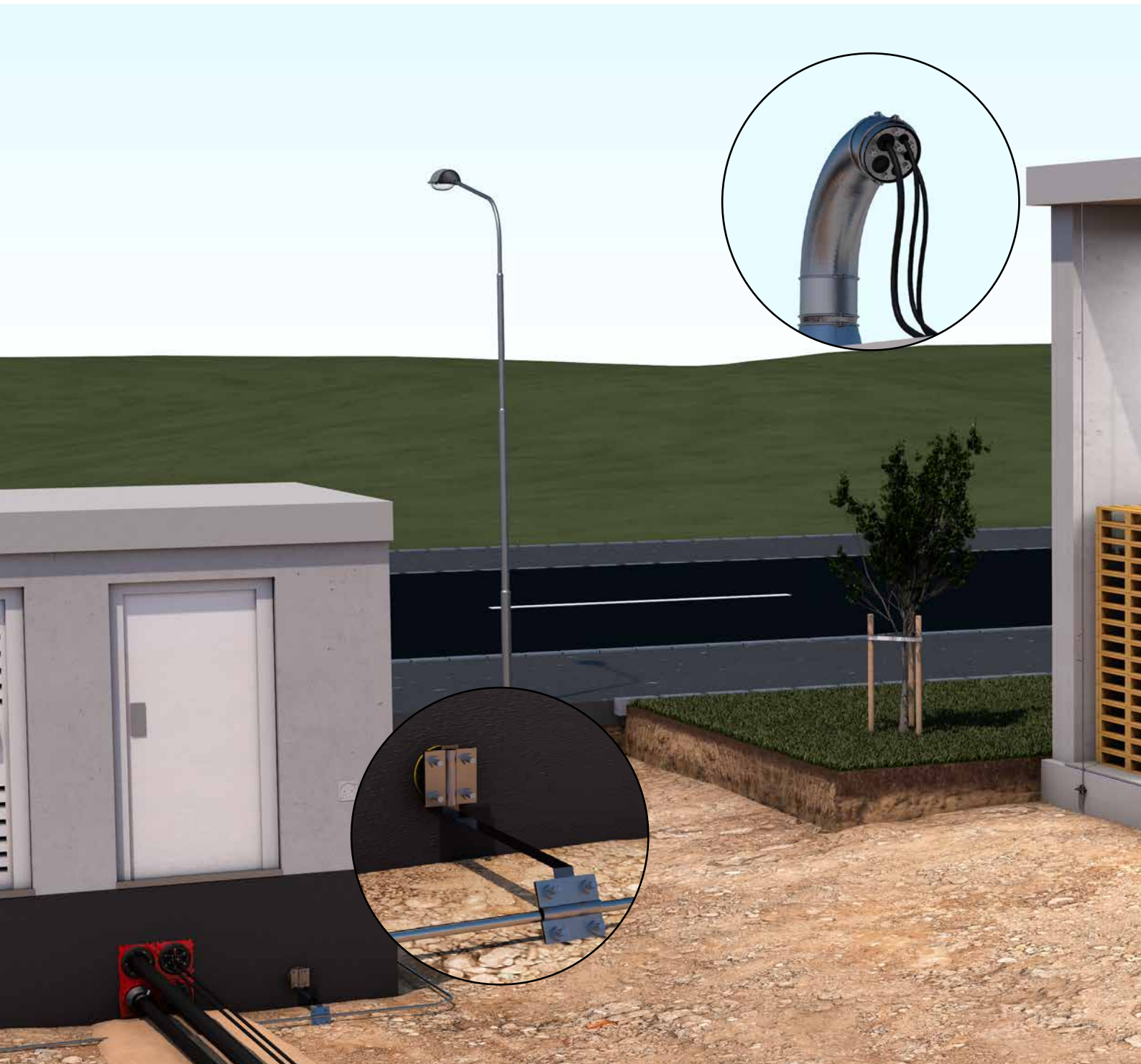

HFM foil sleeves

Vapour barrier foils are increasingly being used on floor slabs. Connection to the relevant building entries or media lines, however, is often not taken into account in advance, or is improvised. For the most common scenarios, the HFM foil sleeve from Hauff-Technik represents the optimal solution.

Roof entries

Sealing cables and lines for solar, HVAC and mobile communications systems pose our customers with major challenges every single time. Hauff-Technik can offer roof entries like the SHD swan neck entry or HRD-FUFF(A) wall sleeves with fixed/loose flange that are tailor-made to provide the best possible solution for the corresponding roof construction and customer-specific application. The seals between the building and the cables and lines are established with press seals tailor-made specifically to meet customer requirements. We are happy to propose other solutions on request.



Earthing wall collar

for round and flat conductors

HMK

Water barrier flange for water pressure-tight integration of earth conductors in floor slabs or concrete walls.





Scope of delivery

- 1 piece of water barrier flange
- 2 pieces of clamping straps

Tightness

- gastight and watertight

Figure	Diameter range (mm)	Wall collar OD (mm)	Article code	Packing unit	Article number	GTIN
	8-10	105	HMK8-10	1	3030300037	4052487194068
				50		4052487223539
	30*3,5	120	HMK30*3,5	1	3030303257	4052487222020
				10		4052487197137

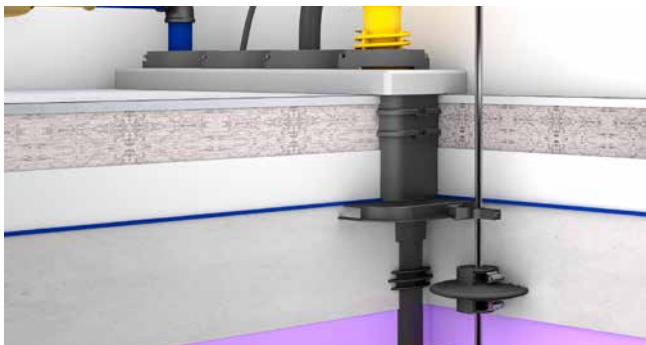

Accessories HFM foil sleeves

Figure	Item	Bestellbezeichnung	Article number	GTIN
	Foil sleeve for entries through the floor slab	HFM 1x4-8	3030370203	4052487227971
		HFM 1x8-12	3030370204	4052487227988

Earthing entry

HEA



For installation flush with the formwork in waterproof concrete. Earthing connections can be made using the thread on both sides of the conductor core.

USP

- patented anti-twist protection through special contour of the contact disc

- Contact washer: Ø 72 mm
- For wall thicknesses: > 70 mm

Tests/Standards

- DIN 18014
- DIN EN 62305-3
- VDE 0185-305-3 (with lightning protection application)

Scope of delivery

- 2 pieces of protective covers with 4 nail holes

Dimensions

- Conductor core: round, Ø 25 mm

Threaded bolt	Wall thickness (mm)	Article code	Article number	GTIN
M12	70	HEA M12/70	1700010070	4052487044479
M12	100	HEA M12/100	1700010100	4052487044493
M12	150	HEA M12/150	1700010150	4052487044509
M12	200	HEA M12/200	1700010200	4052487044516
M16		HEA M16/200	1700020020	4052487044530

Intermediate sizes possible in 10 mm increments.
Also available with M16 thread.

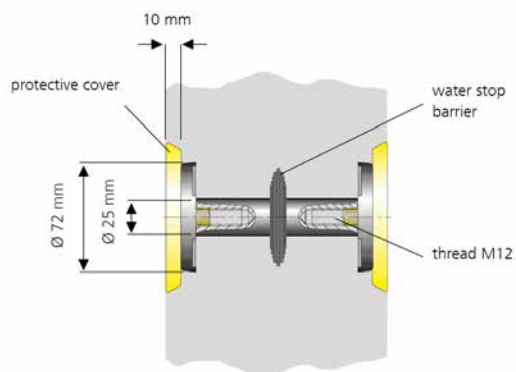

Insulated earthing entry

HEA IS

Specifically for transformer/substations. Installed during the formwork process. Earthing connections to the building can be made with the thread on both sides.



USP

- patented anti-twist protection through special contour of the contact disc

Scope of delivery

- protective cover on both sides

Dimensions

- Conductor core: round, Ø 25 mm
- Contact washer: Ø 72 mm
- Minimum wall thickness: 70 mm

Tests/Standards

- according VDE 0101, EN 50522

Wall thickness (mm)	Threaded bolt	Article code	Article number	GTIN
100	M12	HEA IS M12/100	1710020100	4052487045308
150	M12	HEA IS M12/150	1710020150	4052487045360
200	M12	HEA IS M12/200	1710020156	4052487045384
250	M12	HEA IS M12/250	1710020157	4052487045391
350	M12	HEA IS M12/350	1710020350	4052487206419

Intermediate sizes possible in 10 mm increments.

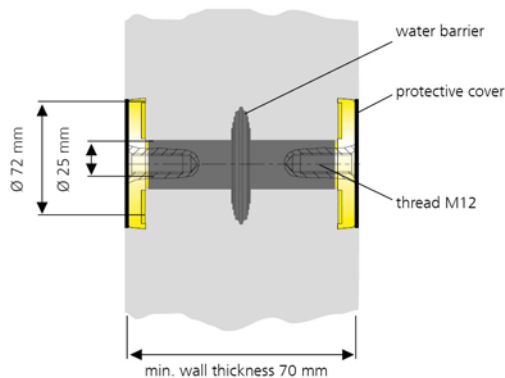

Earthing entry

with connecting lug and cross-clamp



HEA PK

For installation flush with the formwork in waterproof concrete. Earthing connections can be made on the inside and outside with the thread on both sides. An earthing connection can be made to the wall using a lug with a cross clamp.

USP

- patented anti-twist protection through special contour of the contact disc

Scope of delivery

- 1 piece of cross-clamp for connecting reinforcement/foundation earthing
- 2 pieces of protective covers with 4 nail holes

Dimensions

- Conductor core: round, Ø 25 mm
- Conductor core connection: with M16 threaded bolt
- Contact washer: Ø 72 mm

Tests/Standards

- DIN 18014
- DIN EN 62305-3
- VDE 0185-305-3 (with lightning protection application)

Wall thickness (mm)	Threaded bolt	Article code	Article number	GTIN
150	M12	HEA PK M12/150	1700030150	4052487141963
200	M12	HEA PK M12/200	1700030200	4052487136532
250	M12	HEA PK M12/250	1700030250	4052487136587

Wall thickness (mm)	Threaded bolt	Article code	Article number	GTIN
150	M16	HEA PK M16/150	1700031150	4052487164795
200	M16	HEA PK M16/200	1700031200	4052487136655
250	M16	HEA PK M16/250	1700031250	4052487136686

Intermediate sizes possible in 10 mm increments.
Short-circuit resistance up to 10 KA / 1s (VDE 0101 / E DIN EN 50522)

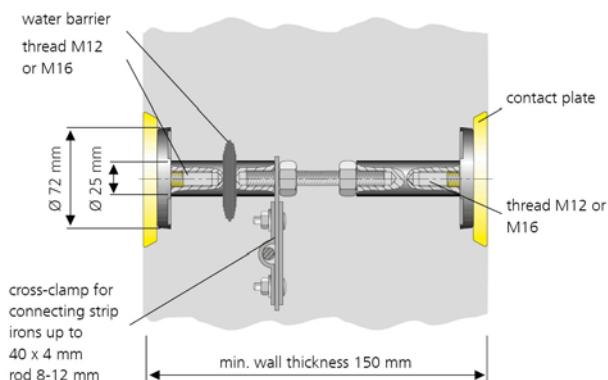

Earthing entry

for retrofit installation



HEA N

Sealing to the wall is provided on both sides by a surface seal, which is pressed to the wall with nuts. Flat or round earthing straps can be connected using a connection lug with cross clamp.

Scope of delivery

- 1 piece of connection lug and cross-clamp

Dimensions

- Contact washer: Ø 72 mm
- Conductor core: M16 threaded rod
- Required drill hole: 20 mm

- Wall thicknesses: up to 600, thicker walls on request

Tests/Standards

- DIN 18014
- DIN EN 62305-3
- VDE 0185-305-3 (with lightning protection application)

Maximum wall thickness	Threaded bolt	Article code	Article number	GTIN
200	M16	HEA N M16/200	1700050010	4052487044592
600	M16	HEA N M16/600	1700050020	4052487044608

Earthing entry

for retrofit installation



HEA ND

For retrofit installation in existing walls with perimeter insulation. Sealing to the wall is provided on both sides by a surface seal, which is pressed to the wall with nuts. Flat or round earthing straps can be connected using a connection lug with cross clamp.

Scope of delivery

- 1 piece of connection lug and cross-clamp

Dimensions

- Contact washer: Ø 72 mm
- Conductor core: M16 threaded rod
- Required drill hole: 20 mm

- For wall thicknesses up to 400 mm, thicker walls on request
- For perimeter insulation: up to 200 mm

Tests/Standards

- DIN 18014
- DIN EN 62305-3
- VDE 0185-305-3 (with lightning protection application)

Maximum wall thickness	Threaded bolt	Article code	Article number	GTIN
400	M16	HEA ND M16/400	1700050120	4052487044615

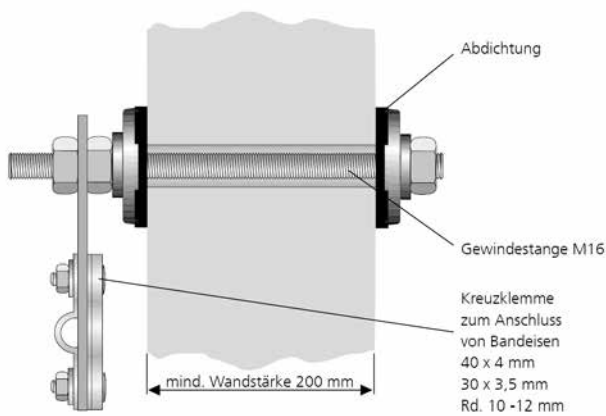

Earthing entry

for building entry according to DIN 18533 (black tank)



HEA W

For wall installation flush with formwork in buildings with outer seal according to DIN 18533. The outer seal is integrated with a fixed/loose flange. The earthing connections are made using the cross clamp or the connection thread.

USP

- patented anti-twist protection through special contour of the contact disc

Scope of delivery

- 1 piece of cross-clamp with M20 thread

Dimensions

- Fixed/loose flange: OD 210 mm
- Conductor core: round, Ø 25 mm

- Conductor core connection: with M16 threaded bolt
- Contact washer: Ø 72 mm
- Minimum wall thickness: 180 mm

Tests/Standards

- To DIN 18014
- DIN EN 62305-3
- VDE 0185-305-3 (with lightning protection application)

Wall thickness (mm)	Threaded bolt	Article code	Article number	GTIN
200	M12	HEA W M12/200	1700040200	4052487136518
	M16	HEA W M16/200	1700041200	4052487136662

Earthing entry

for double walls/element walls



HEA EW

For installation in the precast factory, provides a reliable seal to the precast element and the on-site concrete. Earthing connections can be made using the thread on both sides of the conductor core.

USP

- three water barriers
- patented anti-twist protection through special contour of the contact disc

Scope of delivery

- 2 pieces of protective covers with 4 nail holes

Dimensions

- Conductor core: round, Ø 25 mm

- Conductor core connection: with M16 threaded bolt
- Contact washer: Ø 72 mm
- Minimum wall thickness: 170 mm

Tests/Standards

- DIN 18014
- DIN EN 62305-3
- VDE 0185-305-3 (with lightning protection application)

Wall thickness (mm)	Threaded bolt	Article code	Article number	GTIN
360	M12	HEA EW M12/360	1700020690	4052487127691
180	M12	HEA EW M12/180	1700020510	4052487127639
190	M12	HEA EW M12/190	1700020520	4052487127646
200	M12	HEA EW M12/200	1700020530	4052487127653
240	M12	HEA EW M12/240	1700020570	4052487127660
250	M12	HEA EW M12/250	1700020580	4052487127677
300	M12	HEA EW M12/300	1700020630	4052487127684
400	M12	HEA EW M12/400	1700020695	4052487129497

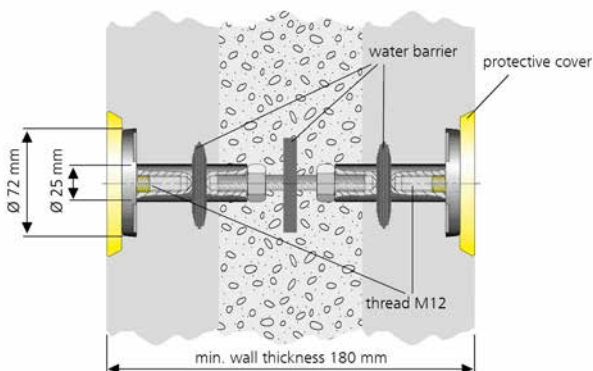

Flexible earthing entry

HEA PF



With flexible steel wire, for offset positioning of earthing connections in the vertical and lateral position. A cross clamp (accessory) can be used to make an optional connection to the armouring.

USP

- patented anti-twist protection through special contour of the contact disc

Scope of delivery

- 2 pieces of protective covers with 4 nail holes

Dimensions

- Conductor core: round, Ø 25 mm

- Contact washer: Ø 72 mm
- Steel cable: Ø 10 mm

Tests/Standards

- DIN 18014
- DIN EN 62305-3
- VDE 0185-305-3 (with lightning protection application)

Threaded bolt	Article code	Article number	GTIN
M12	HEA PF M12/600	1700060010	4052487044622
M16	HEA PF M16/600	1700060020	4052487044639

Additional sizes on request.

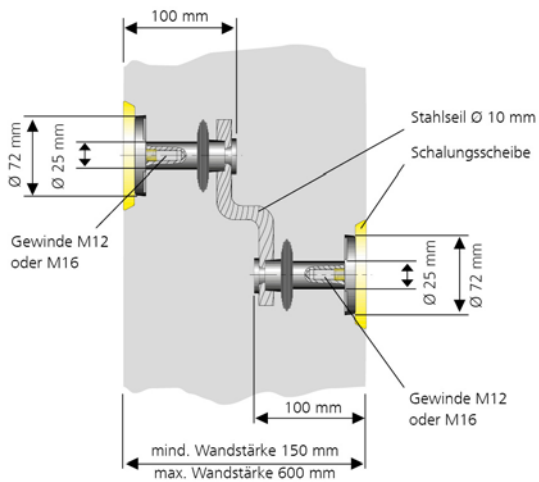

Earthing fixed point

with cross-clamp



HEA P

For earthing connection using the cross clamp, for installation flush with the formwork. An earthing connection can be made using the thread in the conductor core.

USP

- patented anti-twist protection through special contour of the contact disc
- Contact washer: \varnothing 72 mm
- Distance between contact washer and cross-clamp: 120 mm

Scope of delivery

- 1 piece of protective cover with 4 nail holes

Dimensions

- Conductor core: round, \varnothing 25 mm

Tests/Standards

- To DIN 18014
- DIN EN 62305-3
- VDE 0185-305-3 (with lightning protection application)

Threaded bolt	Article code	Article number	GTIN
M12	HEA P M12	1700100010	4052487044745
M16	HEA P M16	1700100020	4052487044752

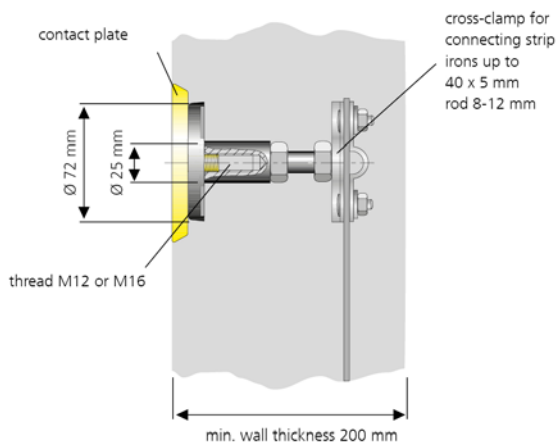

Earthing fixed point

with welding groove



HEA A

For earthing connection using the welding groove, for installation flush with the formwork. An earthing connection can be made using the thread in the conductor core. The HEA-A is primarily used in precast elements.

USP

- patented anti-twist protection through special contour of the contact disc

Scope of delivery

- 1 piece of heat-resistant protective foil

Dimensions

- Conductor core: round, Ø 25 mm

- Contact washer: Ø 72 mm
- Groove for welding connection: for round steel 10 - 12 mm
- Distance between contact washer and weld groove: 40/50 or 70 mm

Tests/Standards

- Short-circuit-tested to VDE 0101
- EN 50522

Distance shuttering - reinforcement	Article code	Article number	GTIN
50	HEA A M12/50	1700300500	4052487124140
70	HEA A M12/70	1700300520	4052487131407

Earthing fixed point

for weld or clamp connection

HEA S

For earthing connection with screw-on steel rod, for installation flush with formwork. An earthing connection can be made using the thread in the conductor core. The HEA-S is primarily used in on-site concrete.



USP

- patented anti-twist protection through special contour of the contact disc

Scope of delivery

- 1 piece of heat-resistant protective foil

Dimensions

- Conductor core: round, Ø 25 mm
- Contact washer: Ø 72 mm
- Minimum wall thickness: 200 mm

Tests/Standards

- Short-circuit-tested to VDE 0101
- EN 50522

Minimum wall thickness (mm)	Threaded bolt	Article code	Article number	GTIN
200	M12	HEA S M12	1700080010	4052487044677
200	M16	HEA S M16	1700080020	4052487044691



Swan neck roof entry

SHD

Suitable for all standard flat roof structures. The flexible and modular system can be adjusted in height and rotated 360°. Possible applications include mobile communications, solar and air conditioning technology.



USP

- low transport weight thanks to single components

Scope of delivery

- 1 piece of swan neck entry with drip cap
- Installation accessories

A (mm)	B (mm)	C (mm)	D (ID mm)	E (mm)	Article code	Article number	GTIN
600 - 950	1050 - 1400	250	100	300	SHD100 fvz	1001094300	4052487025829
	1175 - 1525	300	150	350	SHD150 fvz	1001094500	4052487025843
	1300 - 1650	350	200	400	SHD200 fvz	1001094000	4052487025805
	1550 - 1900	450	300	500	SHD300 fvz	1001095000	4052487025867

A = Telescopic range min/max, B = Total height, C = Hole pattern 4 x Ø 12 mm, D = Max. core drill diameter, E = Edge dimension base plate

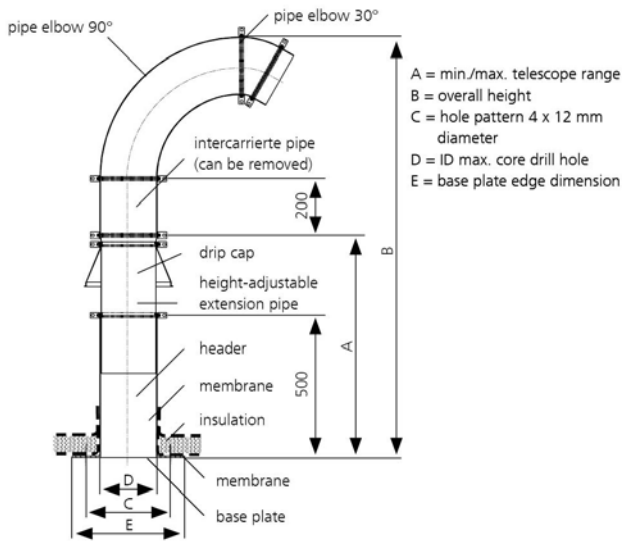

Swan neck cable seal

SKD G ZxD b30 A2/EPDM55

A press seal designed for the swan neck entry SHD which is installed after cables have been laid.



Scope of delivery

- 1 piece of lubricant stick

Dimensions

- Press plates: 5 mm

- Outer diameter adapted to the nominal width of the swan neck entry
- Sealing width: 30 mm, on request 60 mm

Figure	Item	Bestellbezeichnung	Article number
	Swan neck cable seal	SKD100 G ZxD b30 A2/EPDM55	*
		SKD150 G ZxD b30 A2/EPDM55	
		SKD200 G ZxD b30 A2/EPDM55	
		SKD300 G ZxD b30 A2/EPDM55	

Article number and GTIN on request



Foil sleeve

for entries through the floor slab

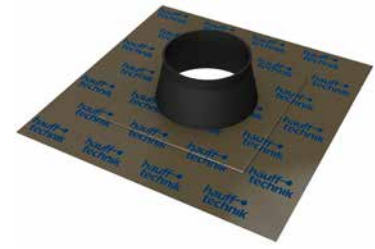

HFM

Hauff foil sleeve for the safe connection of penetrations through the floor slab to a vapour barrier foil, radon foil or other sheet-like sealing on the floor slab.

USP

- easy integration of the vapour barrier or radon foil
- prevents convection and therefore the ingress of radon gas into the building

Tightness

- gastight
- radon-proof

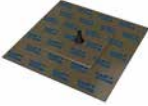
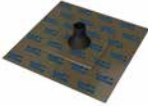

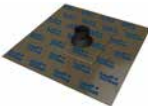

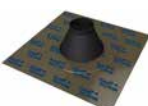

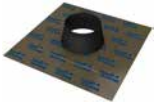
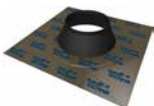
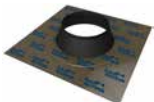
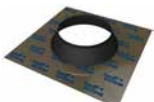
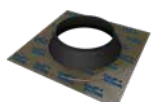

Figure	Number of cables/medium	Size (mm)	Article code	Article number	GTIN
	1	150 x 150	HFM 1x4-8	3030370203	4052487227971
	1	150 x 150	HFM 1x8-12	3030370204	4052487227988
	1	150 x 150	HFM 1x15-22	3030370206	4052487227995
	1	150 x 150	HFM 1x25-32	3030370207	4052487228008
	1	230 x 230	HFM 1x32-40	3030370208	4052487228015
	1	230 x 230	HFM 1x40-55	3030370209	4052487228022
	1	230 x 230	HFM 1x50-72	3030370210	4052487228039



Figure	Number of cables/medium	Size (mm)	Article code	Article number	GTIN
	1	230 x 230	HFM 1x72-90	3030370211	4052487228046
	1	320 x 320	HFM 1x100-110¹⁾	3030370212	4052487228053
	1	320 x 320	HFM 1x125-135	3030370213	4052487228060
	1	350 x 350	HFM 1x150-165	3030370214	4052487228077
	1	420 x 420	HFM 1x200-220	3030370215	4052487228084
	1	580 x 580	HFM 1x250-270	3030629494	4052487249973
	1	580 x 580	HFM 1x230-250	3030370217	4052487228091
	1	580 x 580	HFM 1x300-340	3030629495	4052487249980

¹⁾ e.g. suitable for ESG100 FUBO BHPXL10m

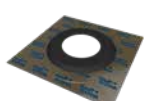
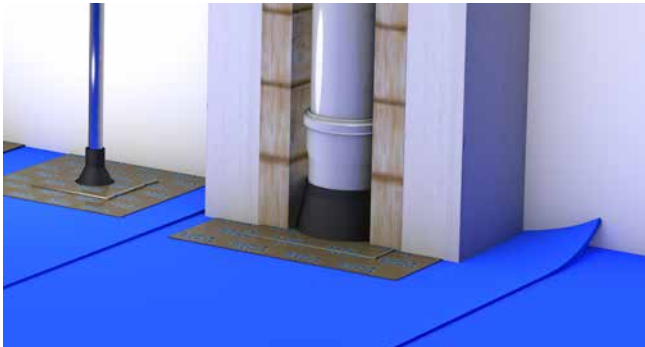

Foil sleeves for earthing conductors and waste water pipes

Accessories

Figure	Item	Article code	Article number	GTIN
	Adhesive primer for Hauff foil sleeves	HFM P	3030375457	4052487238526
	Squeegee for Hauff foil sleeves	HFM APR	3030370823	4052487238519

Fire protection kit S90

For core drills and wall sleeves

HSS KB FR HRD



Gas- and watertight fire protection seal in accordance with fire resistance class S90 to DIN 4102-9 for installation in core drill holes or plastic wall sleeves. Sealing is performed using the HRD press seals. The protection is approved for all types of cable in wall openings up to Ø 300 mm.

USP

- fire protection class S90 in combination with pressure-tight press seals
- one-sided installation of fire-stop pads

Scope of delivery

- Wall openings up to Ø 100 mm: 1 set of HVS pads for full assignment (without cable): 2x HVS-K-250, 3x HVS-KB-60
- Wall openings up to Ø 150 mm: 1 set of HVS pads for full assignment (without cable): 2x HVS-K-400, 3x HVS-K-250, 3x HVS-KB-60

- Stainless steel clamping strap
- 1 piece of Identification sign

Dimensions

- Barrier thickness: min. 280 mm
- Wall thickness at and above: 150 mm
- For core drills ID: 70 - 300 mm
- For plastic wall sleeves ID: 80 - 300 mm

Tests/Standards

- DIBT approval Z-19.15-1906 to DIN 4102-9

Wall sleeve/ core drilled hole ID (mm)	Article code	Article number	GTIN
100	HSS100 KB FR HRD	5030010032	4052487233569
150	HSS150 KB FR HRD	5030010033	4052487233545
200	HSS200 KB FR HRD	2600010007	4052487063395



HSS - installation fire-stop pads in wall insert HSI150-K2, sealing with system cover or SEG-MENTO



HSS - installation in core drill hole with HRD press seals

Fire protection kit S90

for HSI150 system cover

HSS150 HSI150



Gas-tight and watertight fire protection seal in accordance with fire resistance class S90 to DIN 4102-9 for installation in the HSI150 system for walls. Sealing is provided using system covers. The barrier is approved for use with all types of cable in walls.

USP

- fire protection class S90 combined with system covers
- one-sided installation of fire-stop pads

Scope of delivery

- 1 set of HVS pads for full assignment without cable: 1x HVS-K-720, 1x HVS-K-400, 4x HVS-K-250/2, 4x HVS-KB-60
- Stainless steel clamping strap

- 1 piece of Identification sign

Dimensions

- Barrier thickness: min. 440 mm
- Wall thickness at and above: 240 mm
- Maximum package size: 430 x 1270 mm (2x6)

Tests/Standards

- DIBT approval Z-19.15-1906 to DIN 4102-9

Wall sleeve/ core drilled hole ID (mm)	Article code	Article number	GTIN
150	HSS150 HSI150	5030010030	4052487233606



Fire protection kit S90

for HSI150 press seal

HSS150 HSI150 HRD



Gas-tight and watertight fire protection seal in accordance with fire resistance class S90 to DIN 4102-9 for installation in the HSI150 system for walls. Sealing is performed using the HRD press seals. The barrier is approved for use with all types of cable in walls.

USP

- fire protection class S90 combined with HRD 150/160 press seal
- one-sided installation of fire-stop pads

Scope of delivery

- 1 set of HVS pads for full assignment (without cable): 2x HVS-K-400, 3x HVS-K-250, 3x HVS-KB-60
- Stainless steel clamping strap

- 1 piece of Identification sign

Dimensions

- Wall thickness at and above: 150 mm
- Barrier thickness: min. 280 mm
- Maximum package size: 430 x 1270 mm (2x6)

Tests/Standards

- DIBT approval Z-19.15-1906 to DIN 4102-9

Wall sleeve/ core drilled hole ID (mm)	Article code	Article number	GTIN
150	HSS150 HSI150 HRD	5030010031	4052487233583

Fire protection kit S90

For core drills and wall sleeves

HVS KK



Fire barrier in accordance with fire resistance class S90 to DIN 4102-9 for installation in core drill holes or plastic wall sleeves.

USP

- fire protection S90
- one-sided installation of fire-stop pads

Scope of delivery

- Wall openings up to Ø 100 mm: 3x HVS K250/2, 5x HVS KB60, 2x stainless steel belt, 1x identification sign
- Wall openings up to Ø 150 mm: 2x HVS K400, 5x HVS K250/2, 6x HVS KB60, 2x stainless steel belt, 1x identification sign

- Wall openings up to Ø 200 mm: 2x HVS K720, 2x HVS K400, 5x HVS K250/2, 8x HVS KB60, 4x stainless steel belt, 1x identification sign

Dimensions

- Barrier thickness: min. 280 mm
- Wall thickness at and above: 150 mm
- For core drill holes Øi: 70 - 200 mm
- For plastic wall sleeves Øi: 80 - 200 mm

Tests/Standards



- DIBT approval Z-19.15-1906 to DIN 4102-9
- General type certification Z-19.53-2563

Wall sleeve/ core drilled hole ID (mm)	Article code	Article number	GTIN
100	HVS KK100	5030010010	4052487233668
150	HVS KK150	5030010011	4052487233644
200	HVS KK200	5030010012	4052487233620



HSS - installation in core drill hole with HRD press seals

Earthings

Figure	Item	Bestellbezeichnung	Article number	GTIN
	Magnetic formwork disc for Earthings	HEA MGS M12	3030634845	4052487250795
	Connection lug	HEA ASL M12 A4	1700170010	4052487044950
		HEA ASL M16 A4	1700170020	4052487044967
	Hot-melt adhesive tape	Hatetherm	316010000	4052487006668
	Connection bolt	HEA ASB M12 St-tzn	1700110010	4052487044769
		HEA ASB M16 St-tzn	1700110020	4052487044776
		HEA ASB M12 A4	1700110040	4052487044790
		HEA ASB M16 A4	1700110050	4052487044806
	Cross-clamp	HEA KKL M12 St-tzn	1700120030	4052487044875
		HEA KKL M12 A4	3030300276	4052487216418
		HEA KKL M16 A4	1700120020	4052487044868
	Cross-clamp for perimeter insulation applications	HEA KKL DM M12 A4	1700130010	4052487044882
		HEA KKL DM M16 A4	1700130020	4052487044899
	Connection clamp	HEA AKL St-tzn	1700140010	4052487044905
		HEA AKL A4	1700140020	4052487044912



06 Building entries

Single building entries from Hauff-Technik can be relied upon for professional and reliable seals between buildings and supply lines for gas, water, power or telecommunications. Whether through basement walls or floor slabs, they can be installed quickly and safely in a matter of minutes and are gastight and watertight up to 1 bar.

The membrane injection system

The MIS (Membrane injection system) is a universal building entry for core drills in the most common wall types. It provides a gas- and watertight seal for house entries through the floor or the wall.

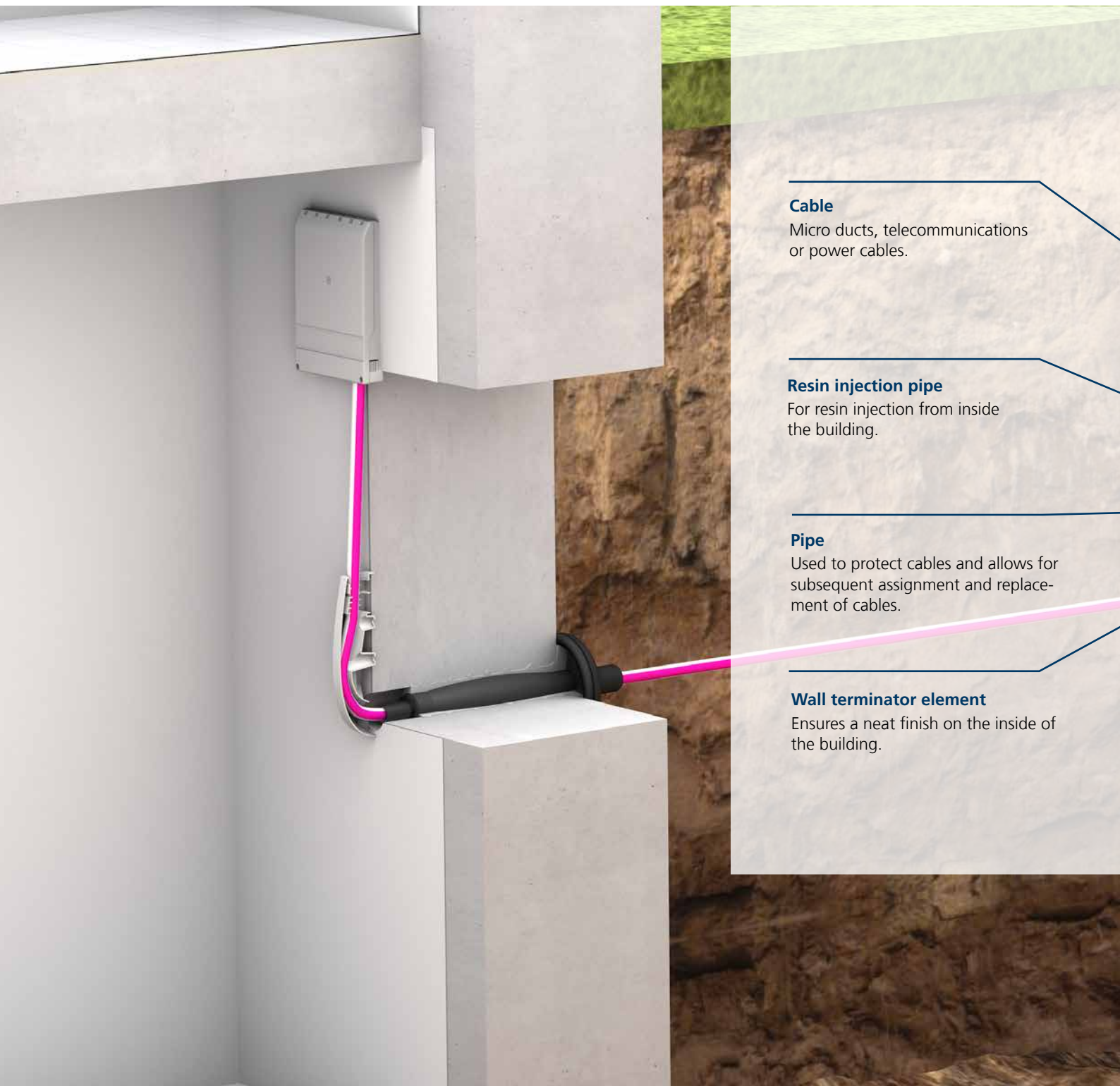

Cable

Micro ducts, telecommunications or power cables.

Resin injection pipe

For resin injection from inside the building.

Pipe

Used to protect cables and allows for subsequent assignment and replacement of cables.

Wall terminator element

Ensures a neat finish on the inside of the building.

The advantage

The MIS is a building entry with an integrated injection membrane which ensures controlled and precise resin injection and significantly reduces the installation time of a building entry.

The usage

The MIS is the perfect and reliable seal for electrical and telecommunication cables, providing gas- and watertight installation in core drill holes with diameters of 25, 40–50, 62–65 or 92–102 mm.

Structure

Waterproofing membrane or liquid applied
Waterproof sealing of the wall.

Perforated membrane
Enables controlled resin expansion through the perforation.

Flange
Covers wall breakouts and reinstates the integrity of the waterproofing.

Seal
Ensures water tight sealing of the media cable, telecommunications or power cables.

Butyl tape
Ensures a tight connection between the wall surface and the flange.

2-Component resin
Expands in the opening and creates a watertight sealing.

Above-ground building entry

for glass fibre duct OD 7 - 12 mm

2LINE OHE 1x7-12 SET10



For feeding and sealing of fibre optic cables through the wall above-ground.

Scope of delivery

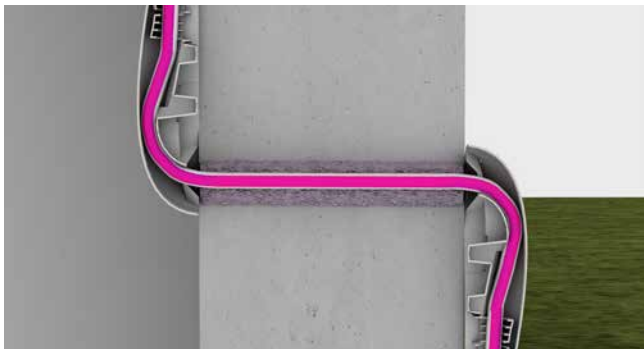

- SET10 consisting of:
 - 10 pieces of building entries
 - Wall plug and screws
- 1 piece of EGO FLOTT sealant
- 10 pieces of corrugated pipe Length: 500 mm (only for variant 2LINE OHE 1x7-12 SET10 WR)

suitable for medium pipe OD (mm)	Article code	Article number	GTIN
7-12	2LINE OHE 1x7-12 SET10	3030340562	4052487240512



Installation graphic - OHE

Accessories

Figure	Item	Article code	Article number	GTIN
	Cartridge gun for resin injection	MIS MW	5060050021	4052487236454
	EGO FLOTT sealant	EGO FLOTT	3030376512	4052487234351

Fibre optic building entry

for buildings with or without a basement



GFH20 PRO

For reliable sealing of fibre optic cables.

USP

- universal building entry with membrane injection system for core holes in the most common types of walls
- enables horizontal or angled installation up to an angle of 45°
- gentle sealing of fibre-optic cables using sealing lips

Scope of delivery

- 1 piece of GFH20
- 1 piece of Hauff Resinator 2-component resin, 80 ml
- 1 piece of mixing nozzle

- 1 piece of wall terminator element
- suitable number of pipe clamps, depending on variant

Dimensions

- Application range: 2 fibre-optic cables with \varnothing 7-10 mm or 1 fibre-optic cable with \varnothing 6 - 13 mm or 1 fibre-optic cable with \varnothing 12 - 16 mm
- for drill holes \varnothing i: 20 mm
- for wall thicknesses starting from 100 mm

Tightness

- gastight and watertight to 1.0 bar

Number of cables/medium	suitable for medium pipe OD (mm)	Article code	Article number	GTIN
2	7 - 10	GFH20 2x7-10 PRO¹⁾	2900001311	4052487209823
1	6 - 13	GFH20 1x6-13 PRO	2900001313	4052487209847
1	12 - 16	GFH20 1x12-16 PRO	2900001315	4052487209861

¹⁾ for 2x10 mm: \varnothing = 22 mm

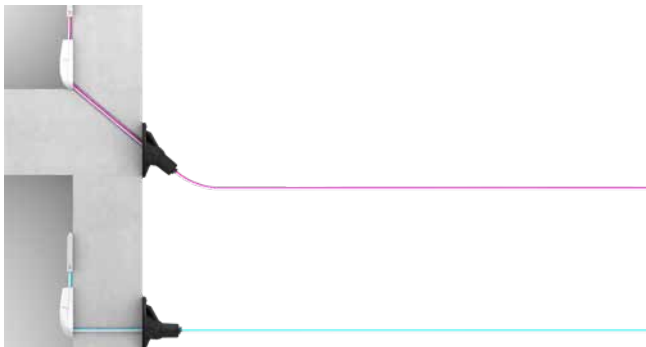

GFH20 PRO - Inclined and horizontal installation



Built-in graphics - GFH20 PRO

Membrane injection system

for buildings with or without a basement



2LINE MIS25 PRO

For reliable sealing of fibre optic cables. For installation in all standard wall types to DIN 18533 W1.1-E, W1.2-E, W2.1-E and waterproof concrete according to DIN 1045. Includes 2-component resin Resinator.

USP

- controlled resin expansion thanks to the perforated membrane
- toolless assembly with Resinator double syringe
- horizontal or angled installation, up to an angle of 45°

- 1 piece of Resinator dual syringe, 25 ml
- 1 piece of wall terminator element

Dimensions

- for drill holes Øi: 25 mm
- for wall thicknesses starting from 150 mm

Scope of delivery

- 1 piece of 2LINE MIS25

Tightness

- gastight and watertight to 1.0 bar

Number of cables/medium	suitable for medium pipe OD (mm)	Article code	Article number	GTIN
1	6-13	2LINE MIS25 1x6-13 PRO	3030477964	4052487242905

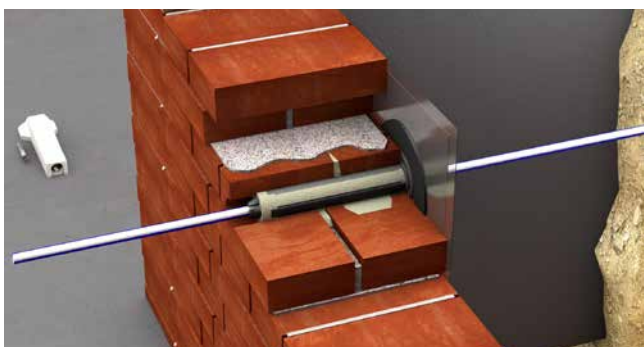
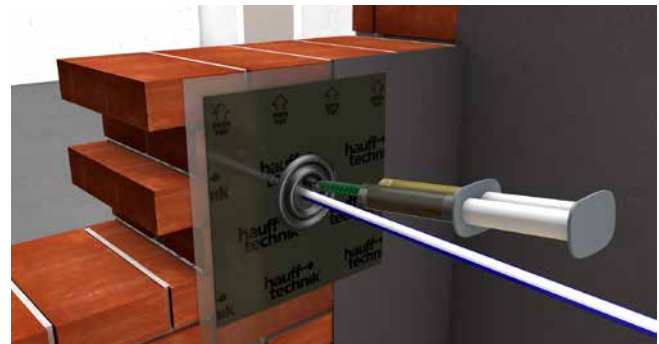
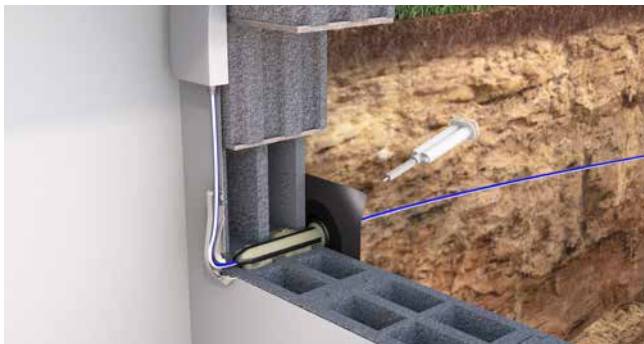

Accessories

Figure	Item	Article code	Article number	GTIN
	2-component resin Resinator expansion resin	EH Resinator 25	3030506759	4052487244114

Membrane injection system

for buildings with a basement

MIS40D



For reliable sealing of fibre optic and telecommunications cables.

USP

- universal building entry with membrane injection system for core holes in the most common types of walls
- controlled resin discharge through perforated membrane
- sealing lips ensure gentle seal for cables/pipes

- 10 pieces of MIS40
- 10 pieces of wall terminator element
- 10 pieces 2-component resin Resinator, 150 ml
- 1 piece of quick tensioning device MIS40 SVS

Dimensions

- For core drills ID: 40 - 50 mm

Tightness

- gastight and watertight to 1.0 bar

Scope of delivery

- 1 packing unit:

Number of cables/medium	suitable for medium pipe OD (mm)	Overall length (mm)	Wall thickness (mm)	Article code	Article number	GTIN
2	5 - 7	1000	200 - 900	MIS40D 2x5-7 BL1000 Set10	3030380163	4052487229920
1	9 - 12			MIS40D 1x9-12 BL1000 Set10	3030380164	4052487229913
2	5 - 7	1300	900 - 1.200	MIS40D 2x5-7 BL1300 Set10	3030391736	4052487230681
1	9 - 12			MIS40D 1x9-12 BL1300 Set10	3030391737	4052487230698

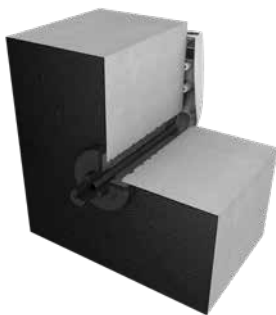

Built-in graphics - MIS40D



Built-in MIS40D

Membrane injection system

for buildings with or without a basement

MIS40S

Suitable for angled installation through the wall or floor slab.



USP

- universal building entry with membrane injection system for core holes in the most common types of walls
- controlled resin discharge through perforated membrane
- sealing lips ensure gentle seal for cables/pipes

Scope of delivery

- 1 packing unit:

- 10 pieces of MIS 40S
- 10 pieces of wall terminator element
- 10 pieces 2-component resin Resinator, 150 ml
- 1 piece of quick tensioning device MIS40 SVS

Dimensions

- For core drills ID: 40 - 50 mm
- Overall length: 1300 mm

Tightness

- gastight and watertight to 1.0 bar

Number of cables/medium	suitable for medium pipe OD (mm)	Overall length (mm)	Wall thickness (mm)	Article code	Article number	GTIN
2	5 - 7	1300	200 - 1.200	MIS40S 2x5-7 Set10	3030380167	4052487229883
1	9 - 12			MIS40S 1x9-12 Set10	3030380168	4052487229876

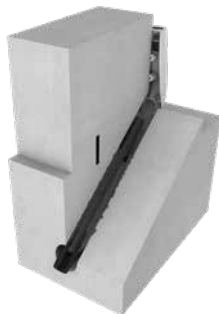

Built-in graphics - MIS40S

Accessories MIS40

Figure	Item	Bestellbezeichnung	VPE	Article number	GTIN
	Quick tensioning device for MIS 40	MIS40 SVS	1	5060020031	4052487236515
	Wall rosette for MIS building entries	WAR40	1	3030300268	4052487216333
	Wall terminator element For fibre-optic building entry	GFH WAE	1	3030315305	4052487226417
	Tubular guide elbow for MIS 40	MIS40 RB	1	5060020011	4052487236539

Membrane injection system

for buildings with a basement

MIS60D

For existing buildings with a basement for reliable sealing of standard water pipes.



USP

- universal building entry with membrane injection system for core holes in the most common types of walls
- controlled resin discharge through perforated membrane
- sealing lips ensure gentle seal for cables/pipes

Scope of delivery

- 1 packing unit:
- 10 pieces of MIS 60D including pre-mounted seal insert
- 10 pieces of wall terminator element (only for communication variant)

- 10 pieces of wall rosette (only with electricity variant)
- 10 pieces 2-component resin Resinator, 150 ml
- 1 piece of quick tensioning device MIS60 SVS



Dimensions

- For core drills Ø: 62 - 65 mm
- For wall thicknesses: from 200 to 1200 mm

Tightness

- gastight and watertight to 1.0 bar
- radon-proof

Number of cables/medium	suitable for medium pipe OD (mm)	Overall length (mm)	Wall thickness (mm)	Article code	Article number	GTIN
4	5 - 7	1000	200 - 900	MIS60D 4x5-7 BL1000 Set10	3030380170	4052487229852
3	10			MIS60D 3x10 BL1000 Set10	3030380171	4052487229845
1	6 - 12			MIS60D 1x6-12 BL1000 Set10	3030380172	4052487229838
1	12 - 18			MIS60D 1x12-18 BL1000 Set10	3030380174	4052487229814
1	18 - 24			MIS60D 1x18-24 BL1000 Set10	3030380175	4052487229807
1	24 - 30			MIS60D 1x24-30 BL1000 Set10	3030380176	4052487229791
1	30 - 34			MIS60D 1x30-34 BL1000 Set10	3030382134	4052487230124
4	5 - 7	1300	900 - 1.200	MIS60D 4x5-7 BL1300 Set10	3030391738	4052487230704
3	10			MIS60D 3x10 BL1300 Set10	3030391739	4052487230711
1	6 - 12			MIS60D 1x6-12 BL1300 Set10	3030391740	4052487230728
1	12 - 18			MIS60D 1x12-18 BL1300 Set10	3030391741	4052487230735
1	18 - 24			MIS60D 1x18-24 BL1300 Set10	3030391742	4052487230742
1	24 - 30			MIS60D 1x24-30 BL1300 Set10	3030391743	4052487230759
1	30 - 34			MIS60D 1x30-34 BL1300 Set10	3030391744	4052487230766

Membrane injection system

for buildings with or without a basement

MIS60S



Suitable for angled installation through the wall or floor slab.

USP

- universal building entry with membrane injection system for angled drill holes through floor slabs or walls
- controlled resin discharge through perforated membrane
- sealing lips ensure gentle seal for cables/pipes

Scope of delivery

- 1 packing unit:
- 10 pieces of MIS 60S
- 10 pieces of wall terminator element (only for communication variant)

- 10 pieces of wall rosette (only with electricity variant)
- 10 pieces 2-component resin Resinator, 150 ml
- 1 piece of quick tensioning device MIS60 SVS

Dimensions

- For core drills Ø: 62 - 65 mm
- Overall length: 1300 mm

Tightness

- gastight and watertight to 1.0 bar

Number of cables/medium	suitable for medium pipe OD (mm)	Overall length (mm)	Wall thickness (mm)	Article code	Article number	GTIN
4	5 - 7	1300	200 - 1.200	MIS60S 4x5-7 BL1300 Set10	3030380178	4052487229777
3	10			MIS60S 3x10 BL1300 Set10	3030380179	4052487229760
1	6 - 12			MIS60S 1x6-12 BL1300 Set10	3030380180	4052487229753
1	12 - 18			MIS60S 1x12-18 BL1300 Set10	3030380182	4052487229739
1	18 - 24			MIS60S 1x18-24 BL1300 Set10	3030380183	4052487229722
1	24 - 30			MIS60S 1x24-30 BL1300 Set10	3030380184	4052487229715
1	30 - 34			MIS60S 1x30-34 BL1300 Set10	3030382135	4052487230131

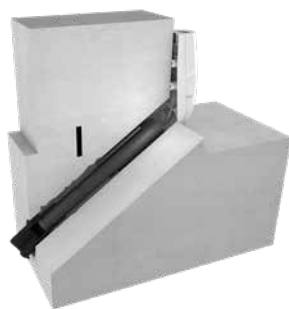

Built-in graphics - MIS60S

Accessories MIS60

Figure	Item	Bestellbezeichnung	VPE	Article number	GTIN
	Quick tensioning device for MIS 60	MIS60 SVS	1	5060020032	4052487236508
	Wall rosette for MIS building entries	WAR60	1	3030300269	4052487216340
	Tubular guide elbow with adapter for MIS 60	MIS60 RB	1	3030300108	4052487113533
	Core drilling cleaning brush for trenchless building connection	MIS REB	1	5060050028	4052487236423
	Wall terminator element For fibre-optic building entry	GFH WAE	1	3030315305	4052487226417

Membrane injection system

for buildings with a basement



MIS90D

For reliable sealing of all electricity and telecommunications lines without additional shrinking using a sealing sleeve.

USP

- universal building entry with membrane injection system for core holes in the most common types of walls
- controlled resin discharge through perforated membrane
- parallel sealing of power, water and communication services

Scope of delivery

- 1 packing unit:
- 6 pieces of MIS 90 including pre-mounted sleeve cap
- 6 pieces of wall collars

Dimensions

- For core drills ID: 92 - 102 mm

Tightness

- gastight and watertight to 1.0 bar

Number of cables/medium overall	Number of cables/medium	suitable for medium pipe OD (mm)	Overall length (mm)	Wall thickness (mm)	Article code	Article number	GTIN
3	1	24-52	1000	200 - 900	MIS90D 1x24-52+2x7 K SET	3030300140	4052487113977
	2	7					
	1	24-52	1300	900 - 1.200			
	2	7					
8	1	24-40	1000	200 - 900	MIS90D 1x24-40+3x7-13+2x5-8+2x7 K SET	3030300143	4052487113960
	3	7-13					
	2	5-8					
	2	7					
	1	24-40	1300	900 - 1.200			
	3	7-13					
	2	5-8					
	2	7					
7	1	13-21	1000	200 - 900	MIS90D 1x13-21+3x7-13-1x5-13+2x7 K SET	3030300144	4052487126670
	3	7-13					
	1	5-13					
	2	7					
	1	13-21	1300	900 - 1.200			
	3	7-13					
	1	5-13					
	2	7					

Penetration of the speedpipe through the flange and outside of the sleeve pipe



Built-in graphics - MIS90D



Built-in MIS90D

Membrane injection system

for buildings with or without a basement



MIS90S

Suitable for angled installation through the wall or floor slab. For reliable sealing of all water and telecommunications lines without additional shrinking using a sealing sleeve.

USP

- universal building entry with membrane injection system for angled drill holes through floor slabs or walls
- parallel sealing of power, water and communication services
- controlled resin discharge through perforated membrane

Scope of delivery

- 1 piece of MIS90S including pre-mounted sleeve cap
- 1 piece of end cap

Dimensions

- For core drills ID: 92 - 102 mm
- Overall length: 1300 mm

Tightness

- gastight and watertight to 1.0 bar

Number of cables/medium	suitable for medium pipe OD (mm)	Overall length (mm)	Wall thickness (mm)	Article code	Article number	GTIN
1	24 - 52	1300	200 - 1.200	MIS90S 1x24-52 SET	2900200510	4052487130905
1	24 - 40			MIS90S 1x24-40+3x7-13+2x5-8 SET	2900200520	4052487130912
3	7 - 13			MIS90S 1x13-21+3x7-13+1x5-13 SET	2900200530	4052487133159
2	5 - 8					
1	13 - 21					
3	7 - 13					
1	5 - 13					



Installation graphics - MIS90S

Accessories MIS90

Figure	Item	Bestellbezeichnung	VPE	Article number	GTIN
	Quick tensioning device for MIS 90	MIS90 SVS	1	5060020034	4052487236492
	Wall rosette for MIS building entries	420 90/100 SG 1x25-63+2x7 EPDM50	1	5060110602	4052487236270
		WAR 90/100 1x63+2x7 EPDM50	1	5060110603	4052487236263

Single building entry MIS

with membrane injection system



MIS200

Universal house entry with membrane injection system for drill holes in the most common wall types for inserting and sealing smooth or corrugated pipes. For direct installation in holes with \varnothing_i 199 - 203 mm, in all common wall types with wall thicknesses from 120 mm.

USP

- universal building entry with membrane injection system for core holes in the most common types of walls
- controlled resin discharge through perforated membrane

Scope of delivery

- 1 piece of Building entry MIS200
- 1 piece of wall terminator element
- 1 piece of 2-Komponentenharz Resinator, 300 ml

- 1 piece of interchangeable insert (for variants smaller than DN 160)
- Stainless steel clip rings (for variants for corrugated pipes)

Dimensions

- For core drills \varnothing : 199 - 203 mm
- for wall thicknesses starting from 120 mm

Tightness

- gastight and watertight to 1.0 bar

For corrugated pipes

Wall sleeve/core drilled hole ID (mm)	Nominal width (mm)	Manufacturer	Type	Article code	Article number	GTIN
200	110	Hegler	HEKAPLAST	MIS200 1x110 WR	3030662669	4052487251839
200	125	Hegler	HEKAPLAST	MIS200 1x125 WR	3030662673	4052487251846
200	160	Hegler	HEKAPLAST	MIS200 1x160 WR	3030662674	4052487251853
200	75	Hegler	HEKAPLAST	MIS200 1x75 WR	3030662659	4052487251815
200	90	Hegler	HEKAPLAST	MIS200 1x90 WR	3030662665	4052487251822
200	125	Austroflex	AUSTROPEX	MIS200 1x125 WR	3030642968	4052487251662
200	145	Austroflex	AUSTROPEX	MIS200 1x145 WR	3030642967	4052487251679
200	160	Austroflex	AUSTROPEX	MIS200 1x160 WR	3030642966	4052487251686
200	125	Thermafex	FLEXALEN	MIS200 1x125 WR	3030642973	4052487251693
200	160	Thermafex	FLEXALEN	MIS200 1x160 WR	3030642972	4052487251709
200	125	Watts Industries Deutschland GmbH	MICROFLEX	MIS200 1x125 WR	3030614538	4052487251716
200	160	Watts Industries Deutschland GmbH	MICROFLEX	MIS200 1x160 WR	3030614536	4052487251723

Other variants on request.

For smooth pipes

Wall sleeve/core drilled hole ID (mm)	Nominal width (mm)	Manufacturer	Type	Article code	Article number	GTIN
200	75	-	-	MIS200 1x75	3030662065	4052487251730
200	90	-	-	MIS200 1x90	3030662058	4052487251747
200	110	-	-	MIS200 1x110	3030662056	4052487251754
200	125	-	-	MIS200 1x125	3030662055	4052487251761
200	140	-	-	MIS200 1x140	3030662051	4052487251778
200	145	-	-	MIS200 1x145	3030661984	4052487251785
200	160	-	-	MIS200 1x160	3030661972	4052487251792



Single building package

for buildings without a basement

ESH Basic FUBO BHPxm

Single building entry suitable for utilities gas, water or power.



USP

- suitable for use with all common gas building entry combinations
- tested pressure-tight duct system
- easy integration of the vapour barrier using the adhesive flange

Scope of delivery

- 1 piece of basic unit, including adhesive flange
- 1 piece of height-adjustable installation fixture with flanges as water barrier

- 1 piece of spiral duct 14078, including sleeve pipe and mounted 3-ribbed seal
- 1 piece of ESH Basic MBK SR1 seal insert
- 1 piece of sealing element for drinking water SDW 1x32/40/50
- 1 piece of sealing element for electricity SDE 1x26-29/36-39/43-46/48-51
- 1 piece of sleeve cap MS78U 1x24-52 for electricity or water
- 1 piece of GMT35 lubricant



Tightness









- gastight and watertight to 1.0 bar

Total system length (m)	Article code	Article number	GTIN
3.0	ESH Basic FUBO BHP3m	3030474697	4052487240710
6.0	ESH Basic FUBO BHP6m	3030474698	4052487240734
10.0	ESH Basic FUBO BHP10m	3030474699	4052487240741
15.0	ESH Basic FUBO BHP15m	3030474700	4052487240758
25.0	ESH Basic FUBO BHP25m	3030474701	4052487240765



Built-in single-line service entry ESH Basic FUBO SR1 EBT with sealing insert ESH Basic MBK SR1, empty pipe system Hateflex14078 MRD/x and the water division

Accessories MIS and GFH

Figure	Item	Bestellbezeichnung	VPE	Article number	GTIN
	Lubricant	GML	1	5020050010	4052487238564
	Cartridge gun for resin injection	MIS MW	1	5060050021	4052487236454
	Cartridge gun for side-by-side cartridges	GFH MW Side-by-Side	1	3030326996	4052487224932
	2-component resin iM3000 expansion resin	EH150/700	1	5060050023	4052487234047
	2-component resin M3000 expansion resin	EH300/1400	1	5060050022	4052487236447
	2-component resin Resinator expansion resin	EH Resinator 80	1	2900001354	4052487216517
		EH Resinator 25	1	3030506759	4052487244114
		EH Resinator 150	1	2900001355	4052487216524
	2-component resin Resinator	EH Resinator 300	1	3030546943	4052487248631

07 Building services outlets

For the planning and distribution of electricity and telecommunications in the garden of the building, our ETGAR builder's packages offer the optimal foundation.

ETGAR is installed in the technical room, near the electrical (main) or sub-distribution, and is already poured into the concrete with when creating the floor slab of the building.

Flexible empty pipes lead from this house design under the floor slab in all directions of the future garden plot.

Thereby the ETGAR building owner package covers naturally all important technical requirements such as the dampness and radon protection of buildings. From this point on, one is completely flexible as to how to proceed with the garden planning.

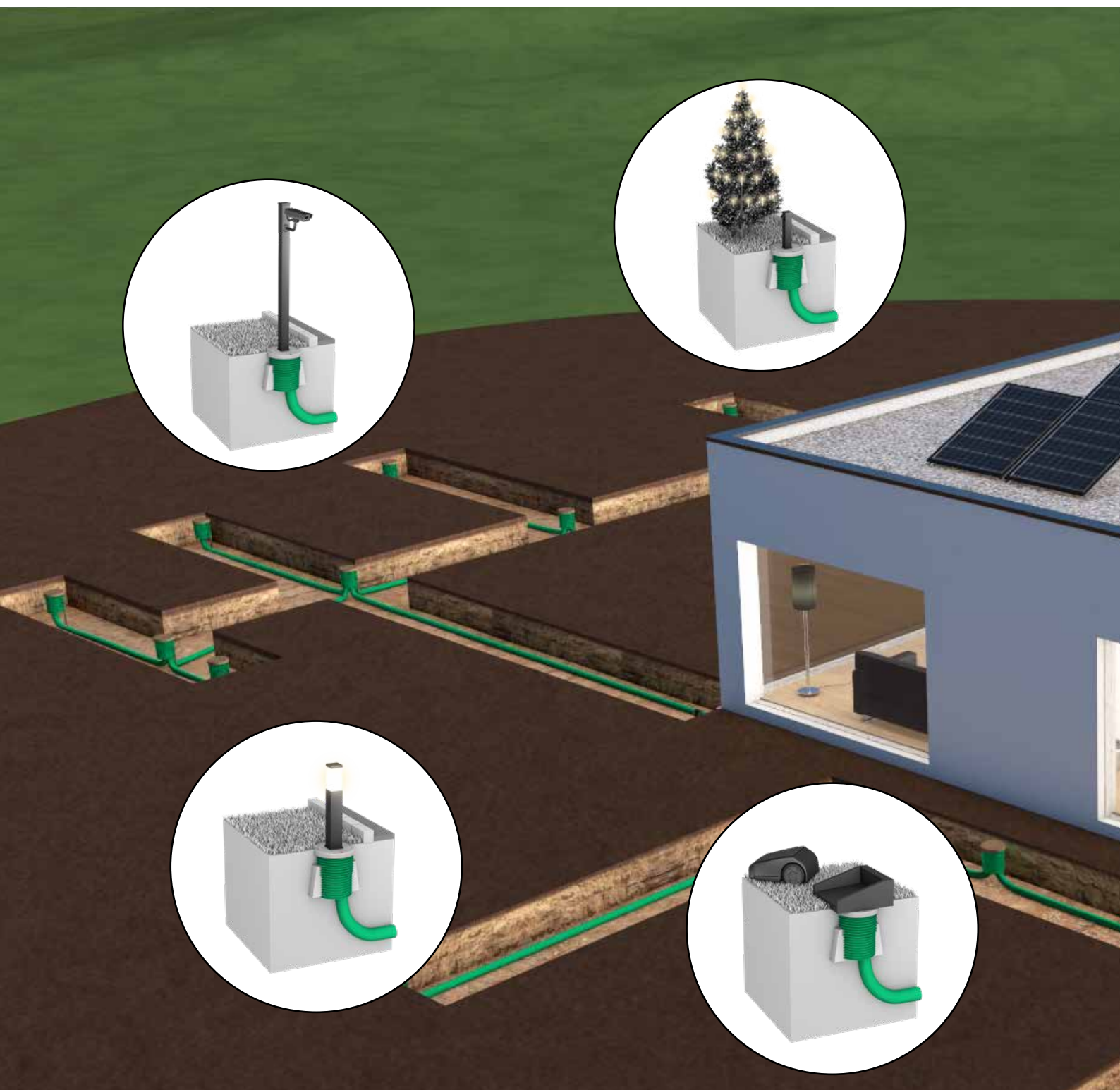

The ETGAR extension and extension sets are the extension sets for the ETGAR builder's package. Once the house is completed, at some point it is time to move on to the exterior landscaping of the property.

Now you can simply extend the access points already set during the construction phase and guide them to the desired location, branch off again, or simply leave them blind closed to be able to use the access at some later date.

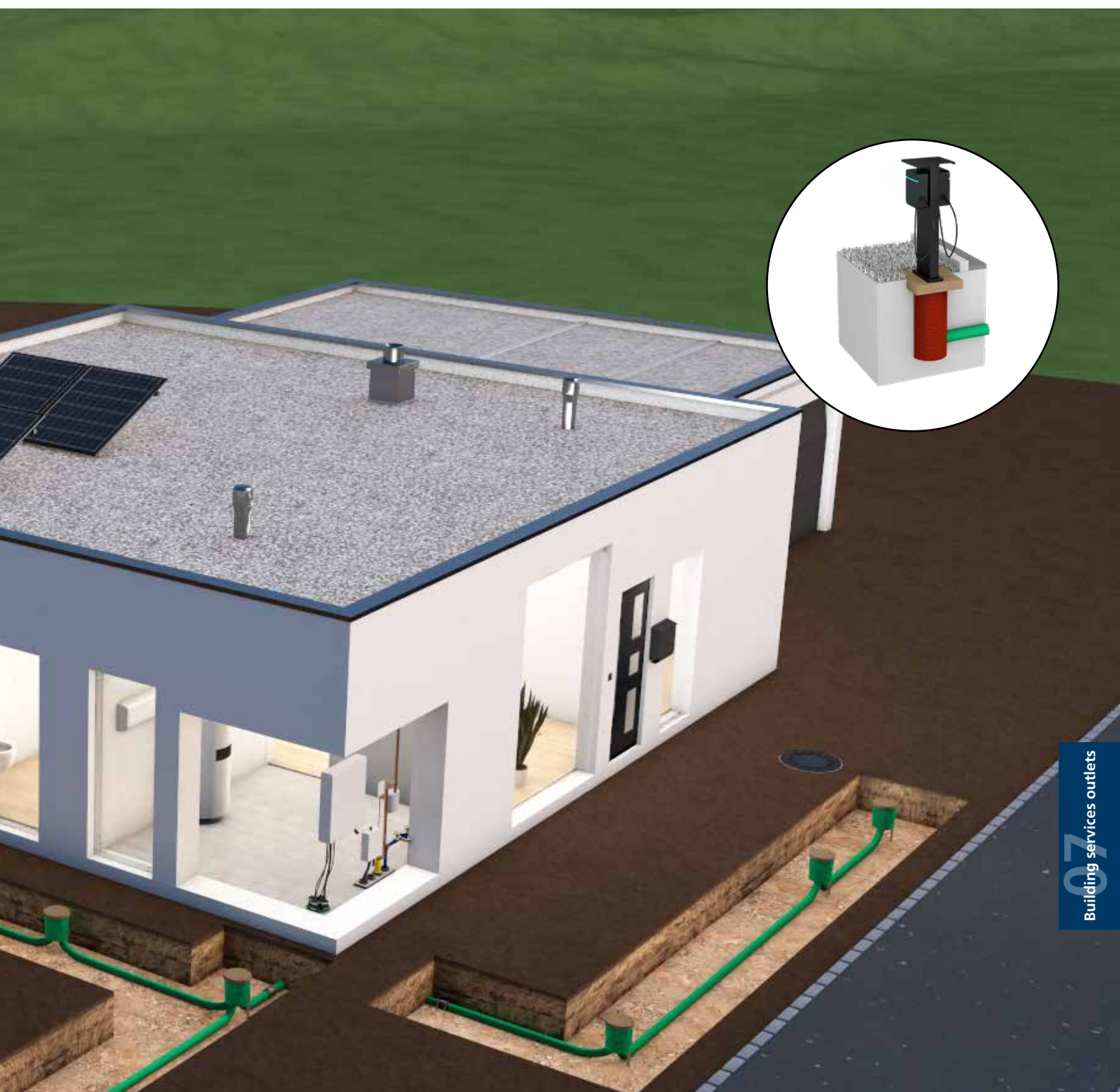

ETGAR building package for building services outlets

for buildings without a basement



HAB ETGAR BHP

For routing and distributing electric power and communication lines from the building to the property's surrounding grounds.

USP

- complete system for distributing the power to the entire property

Scope of delivery

- 1 piece of basic unit for setting in concrete with 4 outlets and a blind cover
- 1 piece of height-adjustable installation fixture
- 1 roll of 30 m corrugated pipe DN 75 incl. pulling aid
- 4 pieces of Interlocking sleeves for corrugated pipe, pre-assembled

- 8 pieces of profile sealing rings for connection of corrugated pipes
- 4 pieces of sealing caps for corrugated pipe
- 1 piece of seal insert, gas- and watertight
- 2 pieces sealing element HAB ETGAR DB 1x24-40+3x7-13 with pipe section
- 2 pieces sealing element HAB ETGAR DB 1x13-21+3x7-13+1x5-13 with pipe section
- 1 piece of GMT lubricant

Tightness

- gastight and watertight

Article code	Article number	GTIN
HAB ETGAR BHP	3030404422	4052487231626



Building services outlets ETGAR MIS

for buildings without a basement



HA ETGAR MIS100S

For routing and distributing electric power and communication lines from the building to the surrounding property.

USP

- flexible building services outlet for distribution of cables or pipes on the property, for retrofit installation
- provision for electrical applications such as lights, sockets and charging points

Scope of delivery

- 1 piece of HA ETGAR MIS100S
- 1 piece of 2-component resin Resinator, 300 ml

- 1 piece of sleeve cap MS75K 1x13-21+3x7-13+1x5-13
- 1 piece of ETGAR connection sleeves
- 1 double sleeve DN 75 + 4 profile seals DN 75

Dimensions

- For core drills ID: 99 - 102 mm
- Overall length: 1.150 mm
- Minimum wall thickness: 200 mm

Tightness

- gastight and watertight to 0.5 bar

Article code	Article number	GTIN
HA ETGAR MIS100S	3030576095	4052487247238

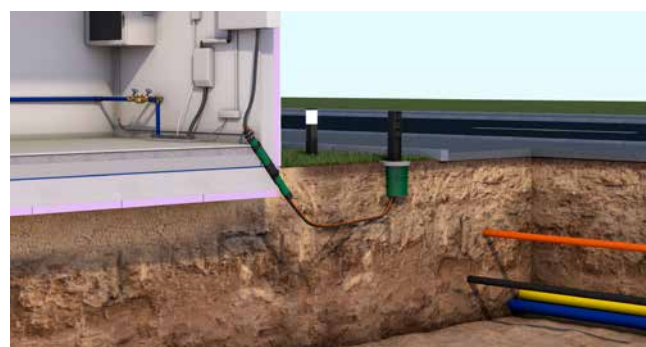
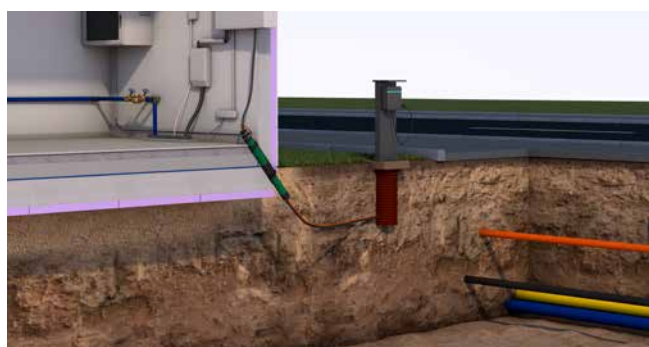

Accessories

Figure	Item	Article code	Article number	GTIN
	Cartridge gun for resin injection	MIS MW	5060050021	4052487236454

ETGAR building package for single building service outlets

for buildings without a basement



HAB-E ETGAR BHP

For routing and distributing electric power and communication lines from the building to the surrounding property.

USP

- complete system for distributing the power to the entire property

Scope of delivery

- 1 piece of ETGAR basic unit including MS75K 1x13-21+3x7-13+1x5-132

- 6-m ETGAR corrugated pipe DN 90
- 1 piece of MS78K 1x13-21+3x7-13+1x5-13
- 1 piece of GMT35 lubricant

Tightness

- gastight and watertight



Accessories

Figure	Item	Article code	Article number	GTIN
	Foil sleeve for entries through the floor slab	HFM 1x72-90	3030370211	4052487228046

ETGAR building package for multi-line building service outlets

for buildings with a basement



HAW-M ETGAR BHP

For routing and distributing electric power and communication lines from the building to the property's surrounding grounds.

USP

- complete system for distributing the power to the entire property
- integrated test valve

Scope of delivery

- Basic component for installation in ETGAR wall sleeve
- Insulating plate for integrating the building insulation in the area of the building services outlet
- 2 pieces of ETGAR sealing elements 1x13-21+3x7-13+1x5-13

- 2 pieces of ETGAR sealing elements 1x26-30+3x5-8+2x7-13
- 16-piece corrugated pipe connection set (4 double sleeves DN75 + 12 profile seals DN75) RAS16
- 1 piece of GMT lubricant

Dimensions

- Compatible with ETGAR wall sleeve, ID: 200 mm
- maximum wall thickness: 500 mm

Tightness

- gastight and watertight to 1.0 bar

Article code	Article number	GTIN
HAW-M ETGAR BHP	3030458211	4052487239936



Accessories

Figure	Item	Article code	Article number	GTIN
	ETGAR wall sleeve for building services outlet for ETGAR BHP	HAW-M ETGAR FR	3030458206	4052487239912
	Multiple building services outlet ETGAR external sealing element for multiple house design ETGAR builder-owner package	HAW-M ETGAR AD	3030490272	4052487241939

ETGAR building package for single building service outlets

for buildings with a basement



HAW-E ETGAR BHP

For routing and distributing electric power and communication lines from the building to the property's surrounding grounds. For installation in a universal MSH Basic-FUBO-E wall sleeve.

USP

- complete system for distributing the power to the entire property

Scope of delivery

- Basic component for installation in universal wall sleeve UFR100/x
- Outer sealing element for installation in wall sleeve.
- Insulating plate for integrating the building insulation in the area of the building services outlet

- 1 piece of ETGAR sealing element 1x26-30+3x5-8+2x7-13
- 4-piece corrugated pipe connection set (1 double sleeve DN 75 + 3 profile seals DN 75) RAS4
- 1 piece of GMT lubricant

Dimensions



- Compatible with UFR wall sleeve, ID: 100 mm
- maximum wall thickness: 500 mm

Tightness

- gastight and watertight to 1.0 bar

Article code	Article number	GTIN
HAW-E ETGAR BHP	3030458216	4052487239967

Accessories

Figure	Item	Article code	Article number	GTIN
	Universal wall sleeve for any type of wall	UFR100/200	3030300244	4052487216098
	ETGAR exterior sealing element for single-line building service outlet for ETGAR building package for single-line building service outlet	HAW-E ETGAR AD	3030491405	4052487242028

ETGAR extension set

for ETGAR BHP

HAB ETGAR VLS

Suitable for extending the duct system of the ETGAR building package for building services outlets.



Scope of delivery

- 30-m corrugated pipe DN 75 green
- 4 pieces of extension sleeves
- 2 pieces of sleeve caps MS75EW 1x24-40+3x7-12

- 2 pieces of sleeve caps MS75K 1x13-21+3x7-13+1x5-13

Tightness

- gastight and watertight

Article code	Article number	GTIN
HAB ETGAR VLS	3030404455	4052487231657

ETGAR foundation box set

for ETGAR BHP

ETGAR FB SET

For routing and distributing electric power and communication lines in the garden, for the safe installation of garden lights, energy charging stations etc. and the connection of ETGAR building services outlet duct systems.



USP

- ready-to-connect foundation system for installation of electrical terminal devices

Scope of delivery

- 1 piece ETGAR foundation boxes
- 1 ETGAR carrier plate contains four attachment screws
- 2 pieces of ETGAR connection sleeves

Article code	Packing unit	Article number	GTIN
ETGAR FB SET	1	3030482075	4052487242202
	4		4052487241908

ETGAR foundation box

for ETGAR BHP

ETGAR FB

For routing and distributing electric power and communication lines in the garden, for the safe installation of garden lights, energy charging stations etc. and the connection of ETGAR building services outlet duct systems. Accessory for the ETGAR building services outlet and for the extension set.



USP

- ready-to-connect foundation system for installation of electrical terminal devices

Scope of delivery

- 1 piece of ETGAR foundation box main unit, incl. closing covers, top and bottom
- 1 piece of height-adjustable installation fixture
- 1 piece of ETGAR connection sleeves
- 1 packing unit: 32 items

Article code	Packing unit	Article number	GTIN
ETGAR FB	1	3030454134	4052487239851
	32		4052487239868



ETGAR foundation box for installing electrical applications

ETGAR carrier plate

for ETGAR foundation box

ETGAR FB TPL



For mounting on the ETGAR foundation box and for versatile, safe and reliable installation of outdoor garden lighting, multi-socket power-outlet strips, and electric power charging stations, etc.

USP

- ready-to-connect foundation system for installation of electrical terminal devices

Dimensions

- Diameter: 270 mm
- Height: 50 / 30 mm
- Diameter of predetermined breaking point: 40 mm

Scope of delivery

- 1 ETGAR carrier plate contains four attachment screws

Article code	Packing unit	Article number	GTIN
ETGAR FB TPL	1	3030454138	4052487239875
	32		4052487239882

ETGAR connection sleeve

for ETGAR foundation box

ETGAR ANS 4x5-25

For ETGAR building services outlets and for sealing cables/pipes at the end of the duct OD 75 mm.



USP

- with segments for maximized application range

Dimensions

- Area of application: 4 cables/pipes OD 5 - 25 mm

Scope of delivery

- 1 packing unit: 12 pieces of sleeve caps

Article code	Packing unit	Article number	GTIN
ETGAR ANS 4x5-25	1	3030449206	4052487239899
	10		4052487239905

Accessories

Figure	Item	Article code	Article number	GTIN
	Connection sleeve for ETGAR building services outlet	ETGAR MA70-84/70-84	3030403633	4052487232302
	Sleeve caps blind sealing for power and communication	ETGAR MS75 K 1x13-21+3x7-13+1x5-13	5060150705	4052487232319
	Sleeve caps for electricity and communication	ETGAR MS75 EW 1x24-40+3x7-12	3030403632	4052487232296
	PE corrugated duct for ETGAR BHP	ETGAR WR75 GR30000	3030401995	4052487231374
	ETGAR insert for building services outlet for buildings without a basement	HAB ETGAR EBT	3030404403	4052487231817
	Seal insert for ETGAR building services outlet	HAB ETGAR ENS	3030401104	4052487231824
	Sealing element for ETGAR building services outlet	HAB ETGAR DB 1x13-21+3x7-13+1x5-13	3030401107	4052487231831
		HAB ETGAR DB 1x24-40+3x7-13	3030403850	4052487231848
	ETGAR accessory set for building services outlet for ETGAR BHP	HAB ETGAR ZBS	3030403681	4052487231855
	Corrugated pipe for ETGAR extension set	WR32 GU25000	3030368195	4052487232081

08 Infrastructure

The network infrastructure forms the elementary basis for the entire basic supply.

Whether electricity, water, gas or telecommunications – only with a well-developed network infrastructure can the various services get to where they are needed.

EV Charging

As a manufacturer of building entries, Hauff-Technik ensures that wherever cables are routed through buildings, the building shell is reliably sealed again and the cables are routed safely into the building.

In addition to building entries, Hauff-Technik offers innovative solutions for underground power distribution in outdoor areas, as well as various foundation systems for e-charging stations, streetlamps and other applications.



Street Lighting

HFR foundation pipes from Hauff-Technik enable groundwork and mast installation to be carried out independently of one another. The foundation pipe with cable entry is installed during the groundwork, while the lighting mast can be brought in at a later point, enabling potential damage during construction work to be effectively avoided. Lighting masts can even be replaced easily and without the need for groundwork.

Hauff-Technik foundation pipes are characterised by high mechanical stability which is achieved through a ribbed plastic design, low weight and consequential easy handling on site.

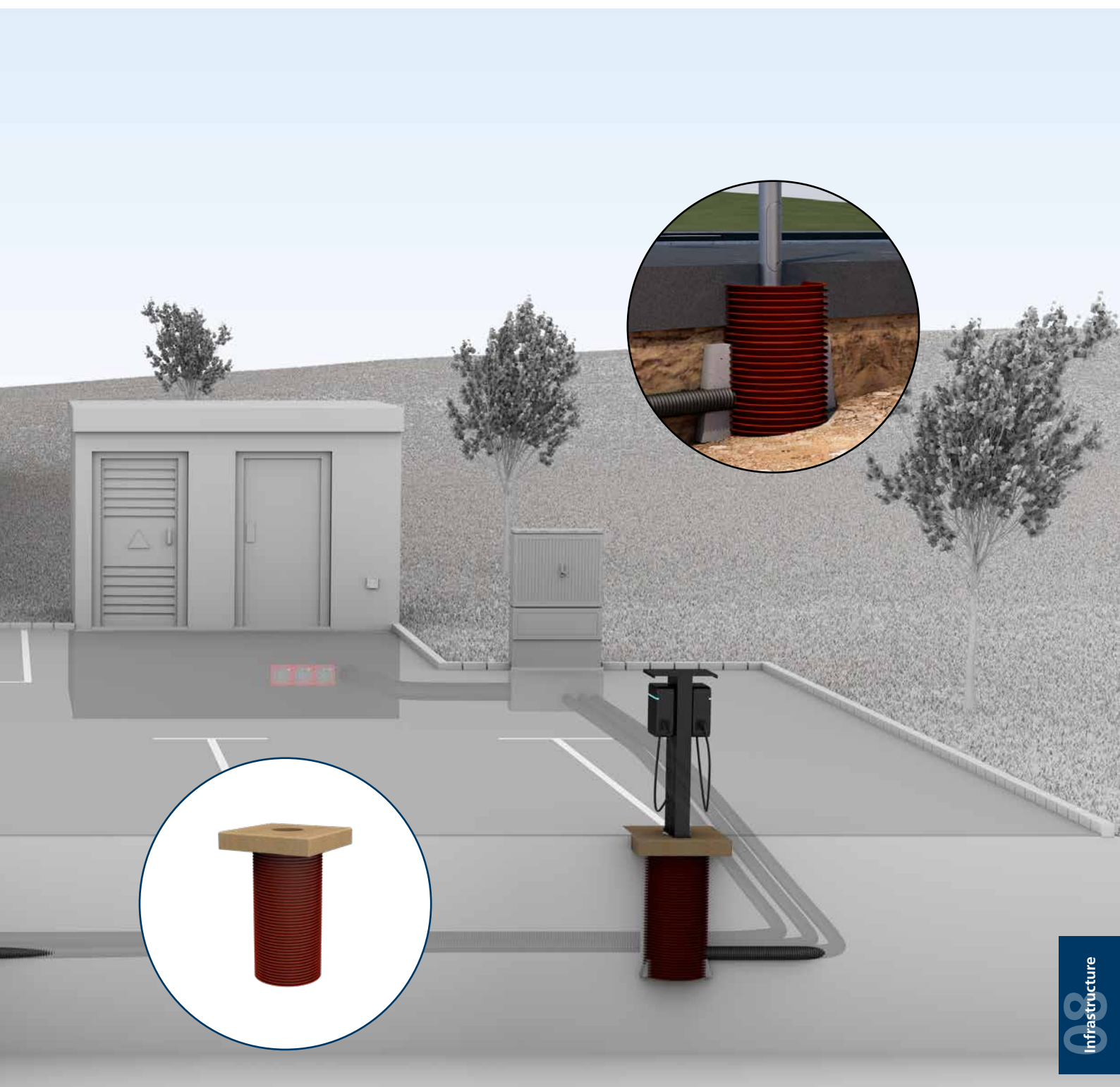

Universal charging station foundation

for the installation of charging stations and charging pedestals



ULF

Universal foundation solution for installing charging stations and charging pedestals. Option for mounting on polymer concrete slab. Connection of power and data cables using a duct connection.

USP

- universal foundation system for various EV charging stations and columns
- adaptation option for ducts
- replacement or exchange of the EV charging station possible without removing the foundation

Scope of delivery

- 1 piece of ULF with blind plate

Dimensions



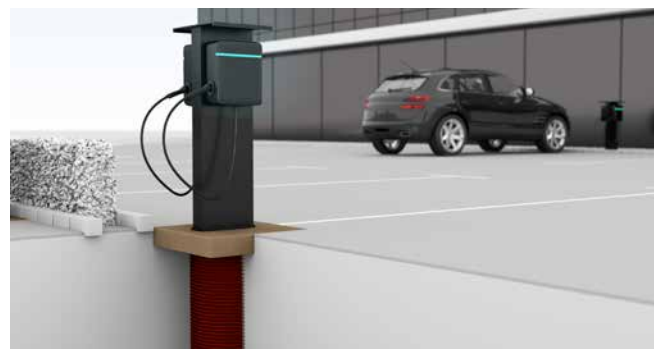

- Total length: 755 mm
- Foundation slab:
 - ULF300: 300 x 300 mm,
 - ULF380: 380 x 380 mm,
 - ULF470: 470 x 470 mm
- Height foundation slab: 80 mm
- Foundation slab opening:
 - ULF300/380: 110 mm,
 - ULF470: 110/150 mm
- Foundation pipe (Øi):
 - ULF300: DN 200, ULF380: DN 250,
 - ULF470: DN 300

Type	Size (mm)	Foundation pipe Øi (mm)	Article code	Article number	GTIN
ULF300	300 x 300	200	ULF300 1x110	3030512350	4052487243452
ULF380	380 x 380	250	ULF380 1x110	3030490218	4052487242851
ULF470	470 x 470	300	ULF470 1x110	3030540367	4052487245111
	470 x 470	300	ULF470 1x150	3030490219	4052487242875

The universal charging station base is compatible with charging stations and wallbox steels from different manufacturers. Find the solution that suits you on our website: www.hauff-technik.uk



Accessories

Figure	Item	Article code	Article number	GTIN
	Hole saw for the universal charging station foundation	LS 76 SET	3030505139	4052487245418
		LS 114 SET	3030505140	4052487245425
	Concrete screw for the universal charging station foundation	BTS 6x60 A2K SW13	3030515187	4052487245456
		BTS 6x60 A4 SW13	3030504407	4052487245449
	ULF Closing cover for permanently closing the opening in the foundation plate of the universal charging station foundation	ULF VD110	3030563712	4052487248235
		ULF VD150	3030563708	4052487248242
	ETGAR connection sleeve for ETGAR foundation box	ETGAR ANS 4x5-25	3030449206	4052487239899

Foundation pipe

for street lighting poles

HFR

Ideal for street lighting poles and a cost-effective alternative to conventional formwork.



USP

- the length of the foundation pipe and the position of the drill hole/cable entry can be freely selected

Foundation pipe Øi (mm)	Foundation pipe Øa (mm)	Pipe length (mm)	Article code	Article number	GTIN
290	335	600	HFR300 I600 1x85/400	915000100	4052487023658
		800	HFR300 I800 1x85/600	915000200	4052487023672
		1000	HFR300 I1000 1x85/600	915000250	4052487023702
		1200	HFR300 I1200 1x85/600	915000300	4052487023740
390	450	800	HFR400 I800 1x85/600	916000200	4052487023870
		1000	HFR400 I1000 1x85/600	916000250	4052487023894
		1200	HFR400 I1200 1x85/600	916000300	4052487023931
		1400	HFR400 I1400 1x85/600	916000400	4052487023962
490	560	800	HFR500 I800 1x85/600	918000200	4052487024068
		1000	HFR500 I1000 1x85/600	918000250	4052487024082
		1200	HFR500 I1200 1x85/600	918000300	4052487024105
		1400	HFR500 I1400 1x85/600	918000400	4052487024129
		1600	HFR500 I1600 1x85/600	918000500	4052487024150

Article code, e.g.:
HFR300 I1200 1x85/750

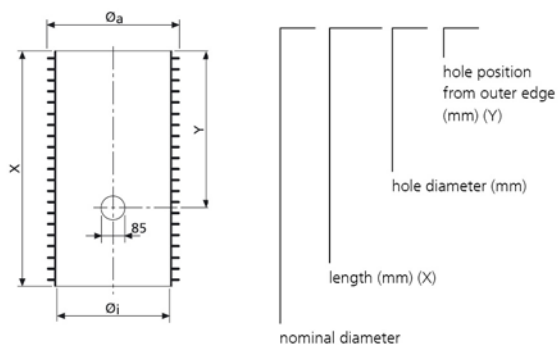

Technical details



Built-in graphics - HFR

Accessories

Figure	Item	Article code	Article number	GTIN
	PE cover for foundation pipe	HFR300 VD	5190020013	4052487233361
		HFR400 VD	5190113980	4052487233354
		HFR500 VD	5199990020	4052487233521

Water exposure classes



Water exposure class W1.1-E

- **W1.1-E soil moisture**
- very water-permeable soil/
fill material very water-permeable

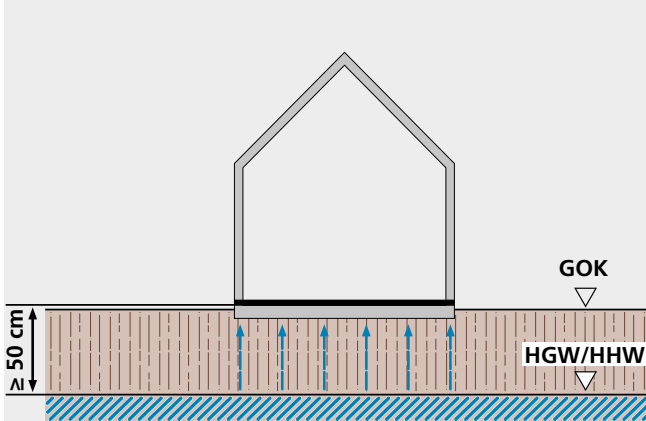

- **W1.1-E soil moisture, non-pressing water**
- very water-permeable soil/
fill material very water-permeable

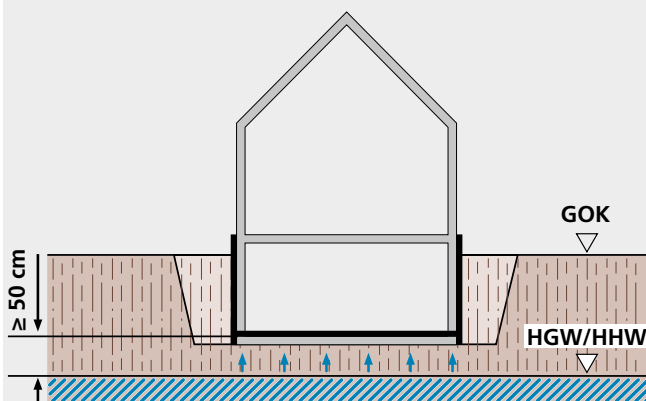

Water exposure class W1.2-E

- **W1.2-E seepage**
- less permeable foundation soil/fill material less permeable $k \leq 10^{-4}$ m/s with drainage

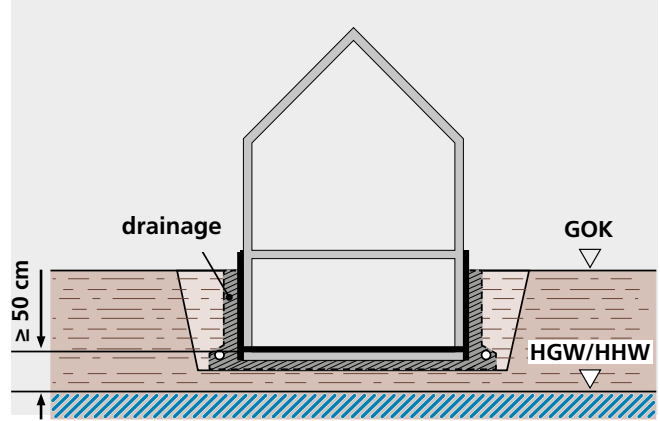



Water exposure class W2.1-E, immersion depth ≤ 3 m

- W2.1-E pressing water up to 3 m
- less permeable foundation soil/ fill material less permeable without drainage

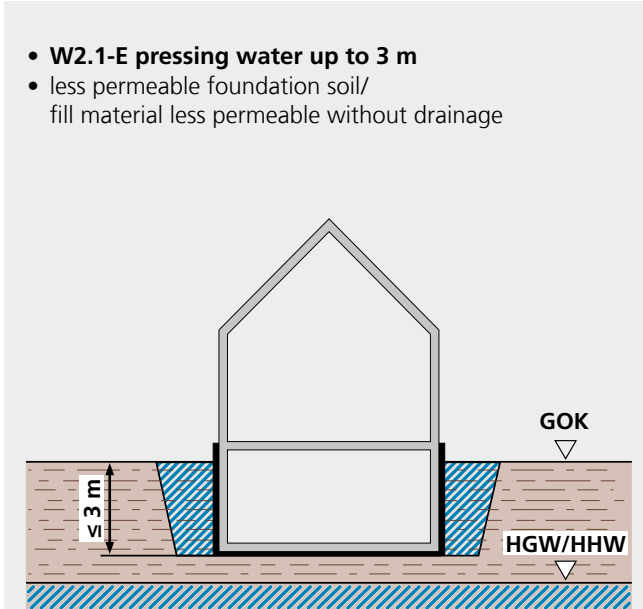

Water exposure class W2.2-E, immersion depth > 3 m

- W2.2-E pressing water more than 3 m
- less permeable foundation soil/ fill material not very water-permeable without drainage

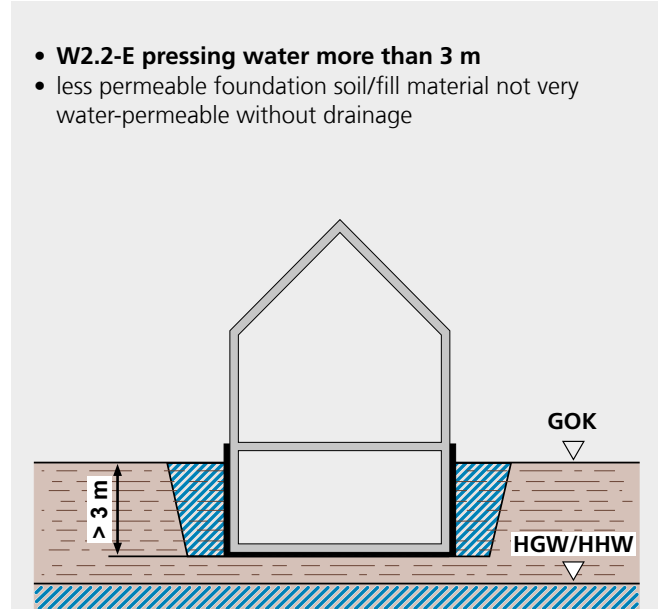

- W2.1-E groundwater up to 3 m, pressing water
- a = foundation depth

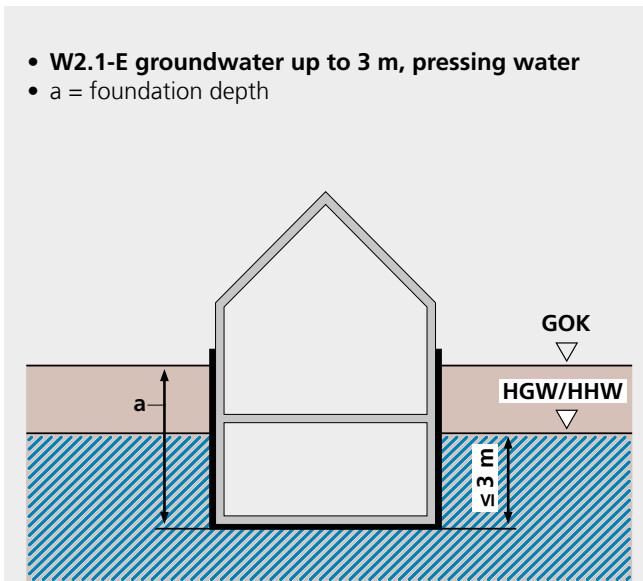

- W2.2-E groundwater/flood level more than 3 m, pressing water
- a = foundation depth

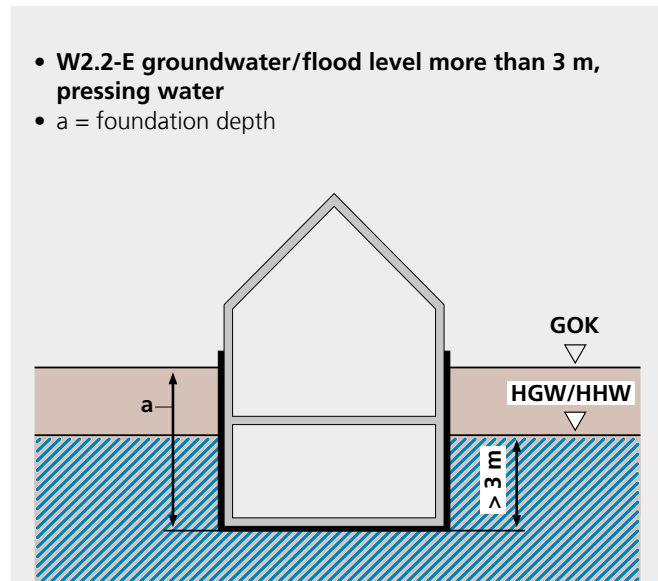

W2.1-E flood level up to 3 m pressing water

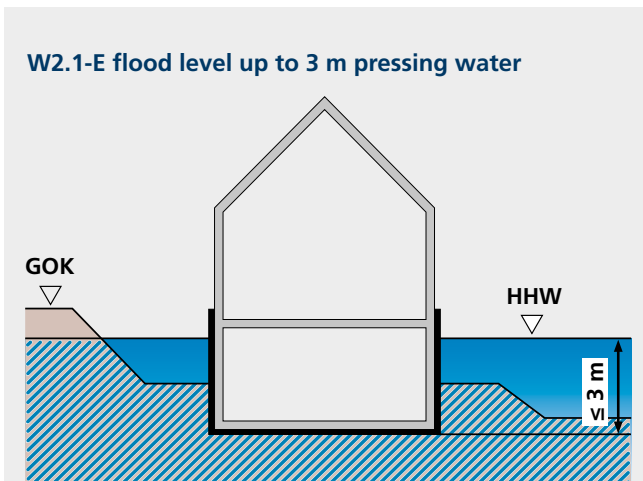

GOK: ground surface
 HGW: highest measured groundwater level
 HHW: highest measured flood level

General Terms and Conditions of Sale and Delivery

I. Scope of Application

1. The following Terms and Conditions of Sale and Delivery shall apply to all contracts concluded between the buyer and us concerning the sale and delivery of goods. They shall also apply to all future business relationships, even if they are not expressly agreed on once again. Deviating terms and conditions of the buyer which are not expressly recognised by us shall not be binding on us, even if we do not expressly object to them. Our Terms and Conditions of Sale and Delivery shall apply even if we carry out the buyer's order unconditionally in the knowledge of contrary or deviating terms and conditions of the buyer.

1.2 The Terms and Conditions of Sale and Delivery shall only apply to entrepreneurs in the sense of Section 14 of the German Civil Code (BGB), legal persons under public law and special funds under public law; it shall not apply to consumers (Section 13 of the BGB).

1.3 Individual agreements made with the buyer in individual cases shall always take precedence over these Terms and Conditions of Sale and Delivery. A written contract or written confirmation on our part is required for the content of such agreements.

1.4 Legally relevant declarations and notifications that are to be submitted to us by the buyer after conclusion of the contract (e.g. notifications of defects, declaration of withdrawal or reduction as well as setting of deadlines) shall be in text form in accordance with Section 126 b of the BGB to be effective. This also applies to the waiver of this text form clause.

1.5 References to the validity of statutory regulations are for the purposes of clarification only. The statutory regulations shall therefore also apply without such clarification, unless they are directly modified or expressly excluded in these Terms and Conditions of Sale and Delivery.

II. Conclusion of Contract

2.1 We may accept any order from the buyer which can be qualified as an offer to conclude a purchase contract by sending an order confirmation within two weeks or by shipping the ordered products within the same period.

2.2 For the purpose of performing a credit check on the buyer, and provided that we have demonstrated a legitimate interest, we shall be entitled to retrieve any address and financial data relating to the buyer that has been stored, including such data that can be determined on the basis of mathematical and statistical methods, via the companies Bürgel Wirtschaftsinformationen GmbH & Co. KG, Postfach 500166, 22701 Hamburg, Germany; Creditreform, Stuttgarter Str. 35, 73430 Aalen, Germany; and Bisnode D&B Deutschland GmbH, Robert-Bosch-Str. 11, 64293 Darmstadt, Germany. To enable decisions concerning the establishment, execution or termination of the contractual relationship, we shall collect or use probability figures calculated using information including address data.

2.3 Our offers shall be non-binding and subject to change, unless we have expressly designated them as binding. This shall also apply if we have provided the buyer with catalogues, technical documentation - drawings, plans, calculations, references to DIN standards, other product descriptions or documents - including in electronic form.

2.4 Acceptance by us can be declared either in text form in accordance with Section 126 b of the BGB (e.g. by order confirmation) or by delivery of the goods to the buyer.

2.5 To the best of our knowledge and experience, we are willing to provide any advice requested by the buyer, that the buyer may require in addition to product descriptions and installation instructions, but without obligation to do so. All details and information as well as applications of any kind shall not exempt the buyer from carrying out his/her own tests to determine the suitability of the products for the intended processes and purposes. Details and information provided by us are non-binding and shall not justify a separate contractual relationship or ancillary obligations from the concluded sale and delivery contract, unless otherwise expressly agreed in writing (text form in accordance with Section 126 b of the BGB is sufficient).

III. Terms and Conditions of Payment - Prices

3.1 Unless otherwise agreed in individual cases, our current prices at the time the contract is concluded apply on an ex-works basis (EXW in accordance with Incoterms 2020) ex-warehouse. Our prices do not include the statutory value added tax. We shall disclose the amount of value added tax applicable on the invoice date separately in our invoice. Unless a fixed price agreement has been made, we reserve the right to make reasonable price adjustments due to changes in wage, raw material, material and distribution costs for deliveries made three months or later after conclusion of the contract.

3.2 In the case of sale by dispatch, the buyer shall bear the transport costs ex-warehouse and the costs of any transport insurance requested by the buyer. Any customs duties, fees, taxes or other public charges shall be borne by the buyer. Should the shipment be made using reusable pallets, these shall only be loaned to the buyer; the buyer shall undertake to properly return or replace such pallets.

3.3 The purchase price shall be due and payable without deductions within 10 days of invoicing and delivery of the goods. Cash discounts are not permitted unless otherwise agreed in writing between us and the buyer. A payment shall not be deemed to have been made until we have the amount at our disposal.

3.4 Upon expiry of the above payment period, the buyer shall be in default without the need for a separate reminder. The purchase price shall bear interest at the applicable statutory rate during the period of default. We reserve the right to assert further compensation claims caused by delay.

3.5 The buyer shall only be entitled to set-off, even if complaints or counterclaims are being made, if the counter-claims have been determined in a final and legally binding manner, have been acknowledged by us or are undisputed. The buyer shall only be entitled to exercise a right of retention if his/her counter-claim is based on the same contractual relationship. We shall be entitled to exercise a right of retention on all receivables arising from the business relationship with the buyer.

3.6 Should our claim to the purchase price be jeopardized by the buyer's inability to pay after conclusion of the contract, we are entitled to refuse performance and, with a deadline set if necessary, to withdraw from the contract (Section 321 of the BGB).

IV. Delivery, Performance Time and Delivery Delays

4.1 Delivery dates or periods which have not expressly been agreed as binding are exclusively non-binding information. Unless otherwise agreed, delivery is made on an ex-works basis (EXW in accordance with Incoterms 2020) from the Hermaringen warehouse, which is also the place of performance. The delivery time quoted by us shall only commence when the technical issues have been clarified. Similarly, the buyer is obliged to fulfil all of the obligations to which he is subject, both properly and in a timely manner. We reserve the right to the defence of lack of performance of the contract.

4.2 In the event that a delivery delay for which we are responsible – and where a fault on the part of our representatives or vicarious agents is to be ascribed to us – is due to a grossly negligent or intentional breach of contract on our part or a slight breach of a fundamental contractual obligation on our part, we shall be liable in accordance with the statutory provisions, with the proviso that in such cases our compensation liability is limited to the foreseeable, typically occurring damage or loss.

4.3 A delivery delay for which we are responsible, which shall be based solely on the culpable breach of a non-fundamental contractual obligation, shall limit the buyer's compensation claim to 25% of the value.

4.4 Should we be completely or partially prevented from fulfilling our obligations due to a force majeure event, we shall be released from fulfilling our contractual obligations until cessation of the force majeure event. We shall however immediately inform the buyer thereof insofar as he/she is not also prevented from fulfilling the contract by a force majeure event. The impossibility of an adequate supply of utilities such as electricity, heating, etc., as well as strikes and lockouts, the outbreak of an epidemic or pandemic, as well as terrorist attacks, earthquakes and/or drought – unless they are of short duration or by our fault – shall be equated to a force majeure event. In the case of a force majeure event, we shall be entitled to postpone our delivery time. In this respect, the buyer shall not be entitled to withdraw from the contract or to claim damages; our liability shall be excluded. Should delivery not be possible within a reasonable period of time or if the buyer can credibly demonstrate that a later delivery is not reasonable for him/her, he/she shall have the right to withdraw from the contract. Any claims of the buyer over and above this, in particular compensation claims, are excluded.

V. Acceptance

5.1 The buyer shall undertake to carry out all actions required for acceptance of our delivery. In the event of a culpable breach of this obligation by the buyer, he/she shall be liable to us for any additional expenses. In such cases, we also reserve the right to assert further compensation claims.

5.2 Should the buyer's acceptance of the delivery be delayed by more than 14 days, we shall grant, in writing, a grace period of 14 days for the acceptance; at the same time, we shall issue a notification that acceptance will be rejected if this defined period expires without the action having been carried out. Should the buyer allow the defined grace period to elapse without the action having been carried out, we shall be entitled to withdraw from the purchase contract by means of a written declaration, or to demand compensation for non-performance. Should the buyer continue to refuse acceptance, or if he/she is clearly unable to pay the purchase price even if a grace period is granted, there shall be no requirement to grant a grace period.

5.3 In such cases, we shall be entitled to claim our loss of profits amounting to 10 % of the agreed purchase price, unless the buyer proves that we incurred a lower loss. Irrespective of this, we shall be entitled to prove and claim higher damages.

VI. Warranty

6.1 The buyer's claims due to defects only exist if the buyer has duly complied with his/her inspection and complaint obligations in accordance with Section 377 of the German Commercial Code (HGB). If the buyer makes changes to our products, fails to follow our operation, installation and maintenance specifications or safety instructions, or does not follow them sufficiently, or uses parts or consumables that have not been approved by us, our warranty obligation shall no longer apply, unless the buyer can prove that the defect concerned is not the result of one of these circumstances. Otherwise, our installation instructions and warranty conditions shall apply.

6.2 If there is a defect in the goods for which we are responsible, we shall undertake to effect subsequent performance – excluding the rights of the buyer to withdraw from the contract or to reduce the purchase price (reduction) – unless we are entitled to refuse to effect subsequent performance due to the statutory regulations.

6.3 The buyer must grant us a reasonable period of time for the subsequent performance. The subsequent performance may be effected either by removal of the defect (subsequent improvement) or by delivery of new goods. In the case of the removal of a defect, we shall bear the necessary costs provided that these do not increase because the goods of the contract are at a location other than the place of performance. We shall not accept claims for reimbursement of expenses if our defective product is combined with another item in such a way that a new functional purpose is created. At our reasonable discretion, we shall be entitled to determine the type of subsequent performance. Any subsequent performance by us shall take place without recognition of a legal obligation, unless the defect has been recognised by us. If the subsequent performance fails, the buyer may, at his/her discretion, demand a reduction in the purchase price (reduction) or declare his/her withdrawal from the contract. The subsequent improvement shall be deemed to have failed after the second unsuccessful attempt, unless further attempts to achieve an improvement are appropriate and reasonable for the buyer in view of the nature of the contractual item.

General Terms and Conditions of Sale and Delivery

6.4 Compensation claims according to statutory provisions due to a defect may only be asserted by the buyer if the supplementary performance fails. The buyer shall not be entitled to demand compensation claims or a reduction in the purchase price in the case of insignificant defects.

6.5 The claims of the buyer due to defects in the purchased item shall lapse 5 years after delivery of the goods to the buyer if they were used for construction work in accordance with their normal method of utilisation and this has caused their defectiveness. This shall also apply to claims of the buyer for compensation or compensation instead of service, and due to all other damage to the buyer's rights arising from the defect; it shall not, however, apply to damage to the life, limb or health of the buyer, or to cases in which we are responsible for the defect as a result of wilful intent or gross negligence, including on the part of our vicarious agents.

6.6 Claims due to defects shall not exist in the case of natural wear and/or damage occurring after the transfer of risk as a result of faulty and/or negligent handling of unsuitable equipment and/or inadequate water quality or incorrect installation. Moreover, claims for defects shall not exist in the case of chemical and/or electrochemical influences on our products, unless we are responsible for them. Our warranty and/or liability shall particularly be void if accessories that have not been approved by us are installed with our products. The contrary shall only apply if the warranty case and/or liability is demonstrably not due to one of the aforementioned reasons for exclusion.

VII. Liability

7.1 Unless otherwise stated in these Terms and Conditions of Sale and Delivery, including the following provisions, or in a separate written agreement between us and the buyer, we shall be liable – for whatever legal reason – in the event of a violation according to the applicable statutory regulations.

7.2 Insofar as we intentionally or through gross negligence violate a contractual obligation or an essential contractual obligation through simple negligence, our obligation to pay compensation shall be restricted to foreseeable damage that is typical for the contract. Essential contractual obligations are such obligations whose fulfilment is essential for the proper execution of the contract and on whose observance the buyer can regularly rely. In all cases of other slightly negligent breaches of obligations – except for those in Section 4.3 – our liability shall be excluded.

7.3 The regulations of the previous paragraphs shall apply to all compensation claims (and particularly to compensation in addition to service and compensation instead of service), regardless of the legal basis, particularly when arising as a result of defects, a breach of obligations from the obligatory relationship, or tortious acts. They shall also apply to claims for compensation of wasted expenditure. However, liability for delivery delays shall be determined exclusively in accordance with Section 4. of these Terms and Conditions of Sale and Delivery. Our unlimited liability as a result of intent, gross negligence, according to the regulations of the German Product Liability Act, any warranty or injury to life, limb or health shall remain unaffected by this limitation of liability.

7.4 A change in the burden of proof that is to the disadvantage of the buyer is not connected to the previous regulations.

VIII. Retention of Title, Use of Our Intellectual Property

8.1 We hereby reserve the title, copyright and all other rights of use to all pictures, calculations, drawings and other documents. The buyer may only pass these on to third parties with our prior written consent.

8.2 The delivery item shall remain our property up to the point at which all our claims against the buyer arising from the business relationship have been satisfied.

8.3 The buyer shall be permitted to process or remodel the delivery item ("processing"). Processing shall be carried out for us. The retention of title shall extend to the products resulting from the processing, mixing or combination of our products at their full value, whereby we shall be considered to be the manufacturer. In case of processing, mixing or combining our goods with products of a third party, the title of which is retained, we shall acquire co-ownership in such processed, mixed or combined goods in proportion to the invoice values. Otherwise, the same shall apply to the resulting product as to the goods delivered under retention of title. To the extent that we acquire ownership or co-ownership, we shall keep the goods safe for the buyer with the due care and diligence of a prudent businessman.

8.4 In the event that the delivery item or the new goods are sold, the buyer hereby assigns to us by way of security his/her claims arising from the resale against his/her customer, plus all ancillary rights, without the need for any additional special declarations. We expressly accept this assignment. The assignment shall apply inclusive of any balance receivables. However, the assignment shall only apply to the amount that corresponds to the price of the delivery item invoiced by us. The share of the receivable assigned to us must be satisfied as a matter of priority.

8.5 If the buyer combines the delivery item or the new goods with property, he/she shall – without the need for any additional special declarations – also assign his/her receivables to which he/she is entitled as remuneration for the combination, at the amount that corresponds to the price of the delivery item invoiced by us. We also expressly accept this assignment.

8.6 Until further notice, the buyer shall be entitled to collect receivables assigned to us. The buyer shall immediately forward payments made towards the receivables assigned to us, up to the amount of the secured receivable. If there is a legitimate interest, and particularly in the case of default of payments, suspension of payments, opening of insolvency proceedings, protest of a bill, or substantiated evidence of over-indebtedness or impending insolvency of the buyer, we shall be authorised to withdraw the buyer's right of collection. Additionally, following prior warning and with a reasonable deadline adhered to, we may disclose the security assignment, make use of the assigned receivables, and demand disclosure of the security assignment by the buyer to his/her customers. If a justified interest is substantiated, the buyer must provide us with the information necessary to assert his/her rights in respect of his/her customers, and surrender the necessary documents.

8.7 For the duration that the retention of title is in place, the buyer shall be prohibited from pledging or assignment as security. In the event of seizure, confiscation or other official orders or acts of intervention by third parties, the buyer must notify us immediately. The resale of the delivery item or the new goods is only permitted for resellers in the ordinary course of business, and only under the condition that the proceeds from the delivery item are paid to the buyer. The buyer must also agree with the customer that the customer shall only acquire ownership once this payment is made.

8.8 If the realisable value of all security rights to which we are entitled exceeds the amount of the secured claims by more than 10%, we shall release a corresponding part of the security rights at the buyer's request. It shall be assumed that the conditions of the previous sentence have been met if the estimated value of the securities to which we are entitled reaches or exceeds 150% of the value of the secured claims. We shall be entitled to choose between the various security rights for release.

8.9 If the buyer breaches obligations – particularly in respect of default of payment – we shall be authorized, without setting a deadline, to demand surrender of the delivery item or the new goods and/or, with a deadline set if necessary, to withdraw from the contract. The buyer shall undertake to surrender possession. A demand for the surrender of the delivery item/of the new goods shall not constitute a declaration of withdrawal on our part, unless expressly stated.

IX. Data Protection, Confidentiality

9.1 The execution of contracts concluded between us and the buyer shall take place in compliance with legal provisions such as the German Federal Data Protection Act (BDSG), the German Telecommunications-Telemedia Data Protection Act (TTDSG) and the European General Data Protection Regulation (GDPR). We give our assurance that the stored data will only be stored for internal use. Otherwise, data will only be transferred to external service providers in compliance with data protection regulations. If necessary, we will conclude separate agreements in which the external service providers undertake to comply with the applicable statutory regulations. Within the scope of our legitimate interest, we exchange creditworthiness information within INDUS Holding AG, Kölner Straße 32, 51429 Bergisch Gladbach and the companies affiliated with us there, as well as with credit agencies. In this context, we refer to the latest version of the data protection statement published on our homepage at www.hauff-technik.de/datenschutz.html.

9.2 Both contracting parties undertake to treat information and data from their mutual business relationship confidentially. In the event of an infringement, we reserve the right to claim damages and take action under criminal law.

9.3 The obligation of confidentiality towards the buyer does not apply to companies affiliated with us within the meaning of Section 15 of the German Stock Corporation Act (AktG) or in the event that the content of the contract/information is already known or generally accessible.

X. Legal Venue, Choice of Law

10.1 Our registered office shall be the place of performance and jurisdiction for deliveries and payments and for all disputes arising between us and the buyer based on the contracts concluded between us and the buyer. The same shall apply to cross-border deliveries resulting from contractual relationships. We shall also be entitled, however, to sue the buyer at the court where he/she has his/her general place of jurisdiction.

10.2 The relations between the contracting parties shall be determined exclusively in accordance with the law of the Federal Republic of Germany. The application of international conventions concerning the sale of movable goods and the UN Convention on Contracts for the International Sale of Goods (CISG) are excluded.

10.3 The German version of the contents of our General Terms and Conditions of Sale and Delivery shall apply exclusively, even if there are versions in other languages.

XI. Miscellaneous

11.1 Should individual provisions of these General Terms and Conditions of Sale and Delivery be or become wholly or partially invalid, void or unenforceable, this shall not affect the validity of the remaining General Terms and Conditions of Sale and Delivery.

11.2 The parties agree that in place of the invalid, void or unenforceable provision, a valid and enforceable provision should be created, the effect of which comes as close as possible to the economic objective that the contracting parties were pursuing with the invalid, void or unenforceable provision.

Version: June 2023

**Hauff-Technik GmbH & Co. KG
Site Hermaringen**

Robert-Bosch-Straße 9
89568 Hermaringen, GERMANY

Tel. +49 7322 1333-0
Fax +49 7322 1333-999

ht.international@hauff-technik.de

**Hauff-Technik GmbH & Co. KG
Site Heidenheim**

Zoeppritzstraße 73
89522 Heidenheim, GERMANY

Tel. +49 7321 94690-0