



CATALOGUE INTERNATIONAL

CABLE SEALS, PIPE SEALS BUILDING ENTRIES & EXTRA

SOLUTION WORLD



Electricity, telecommunication, water, waste water, gas or district heating – whenever a perfectly safe sealing of building entries is required, Hauff-Technik offers the best possible solution.

Innovative cable and pipe entries, building entries and trenchless building connections in professional quality. All from one source.

From stock or customised products. For highest efficiency, user-friendliness and longevity in all buildings.

From single-family homes to complex major projects. Always Hauff. Always reliable. Always tight.

SYMBOLS



This product is radon proof.

In Europe the Directive for protection against the dangers arising from ionising radiation (COUNCIL DIRECTIVE 2013/59/EURATOM OF 5 DECEMBER 2013), obliges the member states to ensure that appropriate measures are in place to prevent radon ingress into new buildings. The statutory reference value in workplaces and dwellings is 300 Bq/m³. Many of our Hauff products have already been tested for radon tightness.



This product has been awarded the „FHRK Quality“ seal in accordance with the FHRK testing guidelines.

Given the huge number of suppliers and manufacturers of sealing solutions, it is easy to quickly feel overwhelmed.

What seals will meet my needs?

Do they meet quality standards?

And what do these standards look like anyway?

Because up to now there have been no standards or guidelines for pipe and cable seals.

The Fachverband für Rohre und Kabel e.V. (Association for House Entries for Cables and Pipes) has addressed precisely this topic and come up with uniform standards. The result is comprehensive and uniform testing guidelines devised in cooperation with expert representatives and the manufacturing industry. This synergy effect has made it possible to cover all needs and requirements for sealing solutions.

What does this mean for you? Quite simply, greater safety, higher quality and better comparability for products that you can trust in.

Catalogue International

CONTENTS

- **CABLE ENTRIES 150**
 - Wall inserts and polymer flange.....4 – 17
 - System covers and system seals for cables ..18 – 27
 - System covers for connecting cable ducts ...28 – 29
 - Cable entry system30 – 33
 - Accessories.....34 – 37
- **CABLE ENTRIES 90**
 - Wall inserts and polymer flange.....38 – 45
 - System covers for cables46 – 47
 - System covers for connecting cable ducts...48 – 49
 - Cable entry system50 – 53
 - Accessories.....54 – 55
 - Cable entry and press seal58 – 59
- **WALL SLEEVES**
 - Standard wall sleeves60 – 75
 - Flange wall sleeves76 – 83
 - Flange wall sleeves/press seals84 – 85
- **PRESS SEALS FOR CABLES**
 - Standard press seals86 – 89
 - Individual press seals90 – 95
- **PRESS SEALS FOR PIPES**
 - Standard press seals96 – 123
 - Corrugated pipe seal.....124 – 125
 - Attachable duct collar126 – 127
- **WASTE WATER ENTRIES**
 - Floor entries128 – 131
 - Wall entries132 – 137
- **EXTRA**
 - Earthing entries138 – 149
 - Earthing fixed points150 – 153
 - Gas-tight and watertight fire barrier S90 154 – 157
 - Roof entries.....158 – 159
 - Foundation pipes.....160 – 161
 - Accessories162 – 163
- **SINGLE BUILDING ENTRIES – OPEN CONSTRUCTION**
 - Wall entry, resin injection system164 – 175
 - Floor entry, resin injection system176 – 181
- **SINGLE BUILDING ENTRIES – TRENCHLESS CONSTRUCTION**
 - Wall entry, resin injection system182 – 183
 - Accessories.....184 – 185
- **BUILDING SEALS AND WALL TYPES.... 186 – 189**
- **GENERAL TERMS AND CONDITIONS OF SALE AND DELIVERY 190 – 191**

Cable entries

Wall sleeves

Press seals

Waste water entries

Extra

Building entries

WALL INSERTS AND POLYMER FLANGE

DOUBLE WALL INSERT, ADJUSTABLE LENGTH FOR SETTING IN CONCRETE

Features and technical data:

- waterproof concrete stress class 1, stress class 2
- continuously adjustable to the required wall thickness on site
- push fit socket frame system for block assembly on site
- connection of system seals possible on both sides
- attachment of system covers for sealing of cables and for connecting smooth and corrugated ducts
- available for double walls/element walls

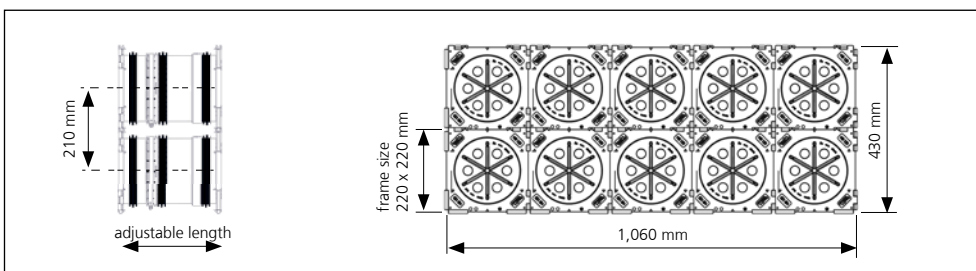

SINGLE WALL INSERT WITH RUBBER PUSH FIT SOCKET SEALS, ADJUSTABLE LENGTH FOR SETTING IN CONCRETE AND CONNECTING SMOOTH CABLE DUCTS

Features and technical data:

- waterproof concrete stress class 1, stress class 2
- continuously adjustable to the required wall thickness on site
- push fit socket frame system for block assembly on site
- connection of system seal possible on one side and integrated push fit socket for connection of smooth cable ducts on the other side

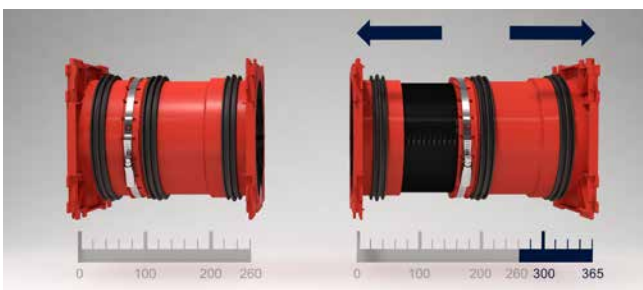

continuously adjustable to the required wall thickness, example HSI150 1x1 K2 Varia 260-365



connection of the cable entry system KES MA150 D



HSI150 GSM Varia applied as a block





sealing with system cover HSI150 DG

Cable entries 150

WALL INSERTS AND POLYMER FLANGE

HSI150 K2 VARIA – CABLE ENTRY				
Figure	Suitable for wall thickness (mm)	Article code	Article number	GTIN
Double wall insert				
	200 – 260	HSI150 1x1 K2 Varia 200-260	3030300084	4052487135009
	260 – 365	HSI150 1x1 K2 Varia 260-365	3030300085	4052487134231
	365 – 470	HSI150 1x1 K2 Varia 365-470	3030300086	4052487140430
	470 – 575	HSI150 1x1 K2 Varia 470-575	3030300087	4052487140454

Including hex key for adjusting the installation length.

HSI150 GSM VARIA – CABLE ENTRY				
Figure	Suitable for wall thickness (mm)	Article code	Article number	GTIN
Single wall insert with integrated push fit socket for cable duct OD 110 mm				
	200 – 260	HSI150 1x1 GSM110 Varia/200-260	2120206120	4052487153577
	260 – 365	HSI150 1x1 GSM110 Varia/260-365	2120206126	4052487153584
	365 – 470	HSI150 1x1 GSM110 Varia/365-470	2120206136	4052487153591
	470 – 575	HSI150 1x1 GSM110 Varia/470-575	2120206147	4052487153607
Single wall insert with integrated push fit socket for cable duct OD 125 mm				
	200 – 260	HSI150 1x1 GSM125-Varia/200-260	2120206220	4052487153614
	260 – 365	HSI150 1x1 GSM125-Varia 260-365	2120206226	4052487153621
	365 – 470	HSI150 1x1 GSM125-Varia 365-470	2120206236	4052487153638
	470 – 575	HSI150 1x1 GSM125-Varia 470-575	2120206247	4052487153645
Single wall insert with integrated push fit socket for cable duct OD 160 mm				
	260 – 320	HSI150 1x1 GSM160 Varia 260-320	2120206326	4052487153652
	320 – 425	HSI150 1x1 GSM160 Varia 320-425	2120206332	4052487153669
	425 – 530	HSI150 1x1 GSM160 Varia 425-530	2120206342	4052487153676
	530 – 635	HSI150 1x1 GSM160 Varia 530-635	2120206353	4052487153683

Including hex key for adjusting the installation length.

When installing packages of HSI150 wall insert, we recommend the use of spacer HSI AH40 for increasing the axial spacing.

In case of GSM160 it is mandatory to use the spacer.



For matching accessories, such as spacer to enlarge the axial spacing to 250 mm, please see from page 34 onwards.



SINGLE WALL INSERT FOR SETTING IN CONCRETE

Features and technical data:

- waterproof concrete stress class 1, stress class 2
- system covers and seals can be connected on one side
- minimum wall thickness 70 mm
- blind cover and blind plate (to be knocked out) guarantee double safety for wall thicknesses 70 – 150 mm (in 10 mm steps)
- available in individual wall thicknesses > 150 mm
- push fit socket frame system for block assembly
- pressure-tight up to 2.5 bar, after concreting

DOUBLE WALL INSERT FOR SETTING IN CONCRETE

Features and technical data:

- waterproof concrete stress class 1, stress class 2
- system covers and seals can be connected on both sides
- minimum wall thickness 100 mm
- available in individual wall thicknesses > 100 mm
- push fit socket frame system for block assembly, available ex stock
- closed on both sides with blind system cover
- special designs for double wall/element walls available
- pressure-tight up to 2.5 bar, after concreting



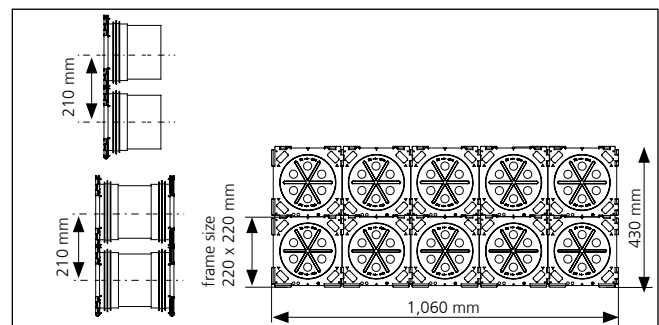

double wall insert HSI150 as block assembly



example 2x5 block for 200 mm wall thickness: article code: HSI150 2x5 K2/250

Cable entries 150

WALL INSERTS AND POLYMER FLANGE

HSI150 – WALL INSERT	
Figure	Article code
Single wall insert minimum wall thickness 70 mm	
	HSI150 1x1 K/X*1
Double wall insert minimum wall thickness 100 mm	
	HSI150 1x1 K2/X*1

*1 The article numbers for the exact wall thicknesses can be found at: www.hauff-technik.com
Standard wall thickness: max. up to 500 mm (gradation in 10 mm)

*2 Restrictions regarding number and size of cables may apply.



Matching accessories such as spacers to enlarge axial spacing to 250 mm or the flexible socket wrench to install and uninstall the system cover are to be found from page 34 onwards.



WALL INSERTS AND POLYMER FLANGE

SINGLE WALL INSERT WITH RUBBER PUSH FIT SOCKET FOR SETTING IN CONCRETE AND CONNECTING SMOOTH CABLE DUCTS

Features and technical data:

- waterproof concrete stress class 1, stress class 2
- system covers and seals can be connected on one side
- integrated push fit socket for connecting smooth cable ducts on one side;
- no additional pipe components required
- minimum wall thickness with pipe connection diameter 110 mm and diameter 125 mm: 120 mm
- minimum wall thickness for pipe connection diameter 160 mm: 180 mm
- maximum wall thickness 500 mm
- pressure-tight up to 0.5 bar, depending on the cable duct used



HSI150 GSM installed

SINGLE WALL INSERT WITH FOLDABLE RUBBER SLEEVE

Features and technical data:

- waterproof concrete stress class 1, stress class 2
- for setting in concrete and connecting corrugated cable ducts
- thanks to the folding sleeve method, no additional pipe components are required
- gas-tight and watertight to 0.5 bar





HSI150 KMA installed





Cable entries 150

WALL INSERTS AND POLYMER FLANGE

HSI150 – WALL INSERT	
Figure	Article code
Single wall insert with integrated push fit socket diameter ID 110 mm, minimum wall thickness 120 mm	
	HSI150 1x1 GSM110/X*1*2
Single wall insert with integrated push fit socket diameter ID 125 mm, minimum wall thickness 120 mm	
	HSI150 1x1 GSM125/X*1*2
Single wall insert with integrated push fit socket diameter ID 160 mm, minimum wall thickness 180 mm, block assembly only in conjunction with spacer	
	HSI150 1x1 GSM160/X*1

*1 The article numbers for the exact wall thicknesses can be found at: www.hauff-technik.com
Standard wall thickness: max. up to 500 mm (gradation in 10 mm)

*2 Restrictions regarding number and size of cables may apply.

HSI150 KMA – WALL INSERT			
Figure	min. carrier pipe \varnothing_o (mm)	max. carrier pipe \varnothing_o (mm)	Article code
Single wall insert with foldable rubber sleeve for setting in concrete and connecting corrugated *cable ducts and direct connection of the spiral conduit hose Hateflex14150, minimum wall thickness 120 mm			
	160	172	HSI150 1x1 KMA172/X**
	106	116	HSI150 1x1 KMA116/X

NEW
by hauff-technik

NEW
coming soon
by hauff-technik

X = wall thickness (mm)

* When connecting corrugated cable ducts, clip rings must be ordered separately. When ordering, please specify tube type and producer.

** The article numbers for the exact wall thicknesses can be found at: www.hauff-technik.com
Standard wall thickness: 120 to 500 mm (gradation in 10 mm)

Spacers HSI150 AH40 are necessary, 2 each already included!

SLANTED SINGLE WALL INSERT FOR SETTING IN CONCRETE

Features and technical data:

- waterproof concrete stress class 1, waterproof concrete stress class 2
- for inclined building entry in all directions for an optimum bend radius
- can be customised for individual wall thickness
- system covers and seals can be connected on one side
- packages can be created ex works (single row)
- 2.5 bar pressure-tight right after concreting

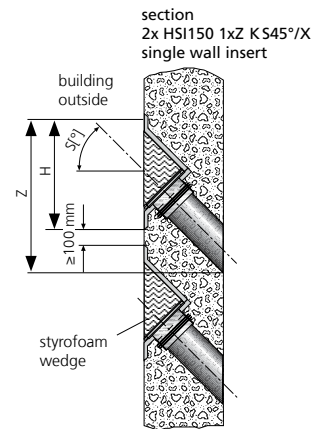

SLANTED DOUBLE WALL INSERT FOR SETTING IN CONCRETE

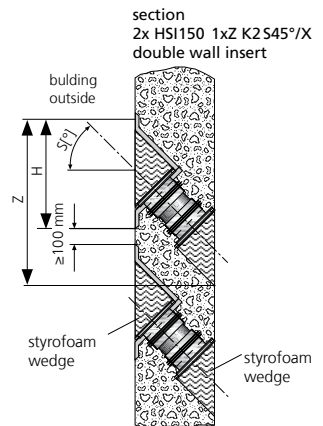

Features and technical data:

- waterproof concrete stress class 1, waterproof concrete stress class 2
- for inclined building entry in all directions for an optimum bend radius
- can be customised for individual wall thickness
- system covers and seals can be connected on both sides
- packages can be created ex works (single row)
- 2.5 bar pressure-tight right after concreting





Cable entries 150

WALL INSERTS AND POLYMER FLANGE

HSI150 1xz K S_°/X			
Figure	Installation angle	Minimum wall thickness (mm)	Article code
Slanted single wall insert S30°, z = number of columns			
	30°	180	HSI150 1xz K S30°/X
Slanted single wall insert S45°, z = number of columns			
	45°	210	HSI150 1xz K S45°/X

Minimum thickness of 200 mm of concrete cover as per WU-Richtlinie (Merkblatt H10) is met in case of wall inserts HSI150 K S30° only by a minimum wall thickness of 350 mm (S45° – 400 mm).

HSI150 1xz K2 S_°/X			
Figure	Installation angle	Minimum wall thickness (mm)	Article code
Slanted double wall insert S30°, z = number of columns			
	30°	240	HSI150 1xz K2 S30°/X
Slanted double wall insert S45° z = number of columns			
	45°	250	HSI150 1xz K2 S45°/X
Slanted double wall insert S45°z = number of columns			
	60°	300	HSI150 1xz K2 S60°/X

Minimum thickness of 200 mm of concrete cover as per WU-Richtlinie (Merkblatt H10) is met in case of wall inserts HSI150 K2 S30 only by a minimum wall thickness of 342 mm (S45° – 385 mm; S60° – 420 mm).

Article number, price and GTIN on request..

WALL INSERTS AND POLYMER FLANGE

SINGLE WALL INSERT FOR SETTING IN CONCRETE, WITH INTEGRATED SEALING FLANGE

Features and technical data:

- waterproof concrete stress class 1, stress class 2
- DIN 18533 W1.1-E, W1.2-E, W2.1-E
- with integrated sealing flange for the processing of polymer modified bituminous thick coatings
- system covers and seals can be connected on one side
- closed ready for installation

DOUBLE WALL INSERT FOR SETTING IN CONCRETE; WITH INTEGRATED SEALING FLANGE

Features and technical data:





- waterproof concrete stress class 1, stress class 2
- DIN 18533 W1.1-E, W1.2-E, W2.1-E
- with integrated sealing flange for the processing of polymer modified bituminous thick coatings
- system covers and seals can be connected on both sides
- closed ready for installation
- closed on both sides with blind system cover



HSI150 1x4 K AF/X

Cable entries 150

WALL INSERTS AND POLYMER FLANGE

HSI150 – WALL INSERT	
Figure	Article code
Single wall insert with integrated sealing flange HSI150 1x1 K AF/X 1 = number of rows, 1 = number of columns, X = wall thickness (mm)	
	HSI150 1x1 K AF/X*
Single wall insert with integrated sealing flange HSI150 1x4 K AF/X 1 = number of rows, 4 = number of columns, X = wall thickness (mm)	
	HSI150 1x4 K AF/X*
Double wall insert with integrated sealing flange HSI150 1x1 K2 AF/X 1 = number of rows, 1 = number of columns, X = wall thickness (mm)	
	HSI150 1x1 K2 AF/X*
Double wall insert with integrated sealing flange HSI150 1x4 K2 AF/X 1 = number of rows, 4 = number of columns, X = wall thickness (mm)	
	HSI150 1x4 K2 AF/X*

* The article numbers for the exact wall thicknesses can be found at: www.hauff-technik.com

WALL INSERTS AND POLYMER FLANGE

DOUBLE WALL INSERT FOR SETTING IN CONCRETE, FOR BLACK TANK WITH FIXED/LOOSE FLANGE

Features and technical data:

- DIN 18533 W2.1-E, W2.2-E
- fixed/loose flange and attachment elements made of stainless steel A2 (AISI 304L) or A4 (AISI 316L)
- sealing flange made of polymer as a connection for system seal
- available as a package with multiple entries arranged horizontally or vertically
- axial spacing in package configuration 250 mm per additional duct

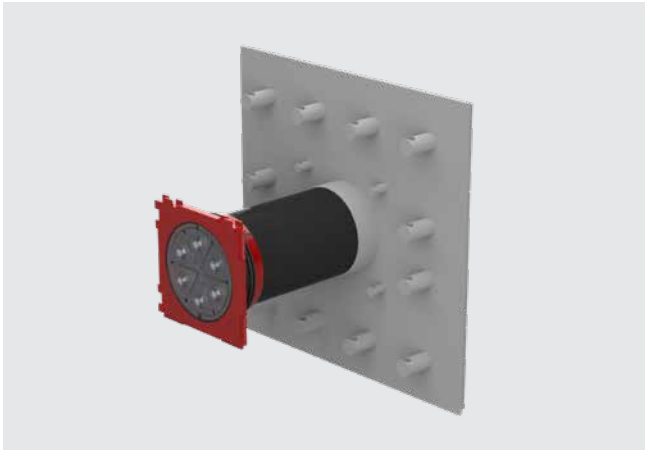

double wall insert HSI150 1x1 FLFE/X for setting in concrete (back)

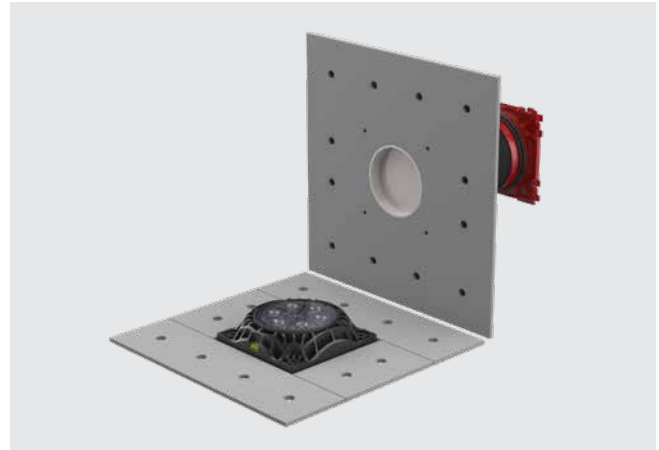



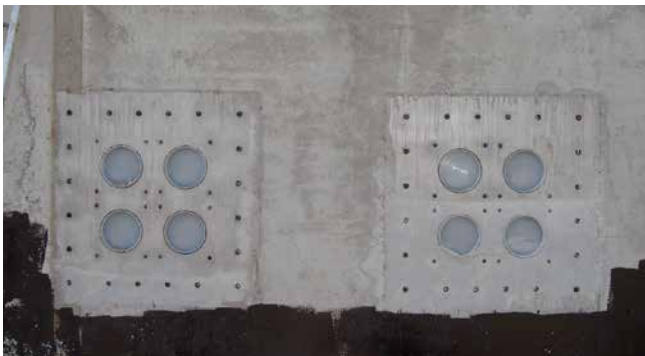

double wall insert HSI150 1x1 FLFE/X (front view). Fixed/loose flange for setting in concrete with sealing flange for connecting system seal.

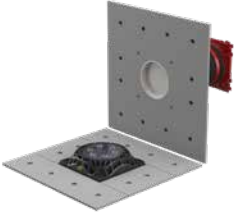

concreted fixed flange of the double wall insert HSI150 2x2 FLFE/X

Cable entries 150

WALL INSERTS AND POLYMER FLANGE

HSI150 FLFE/X – DOUBLE WALL INSERT	
Figure	Article code
Fixed/loose flange wall sleeve, galvanized for setting in concrete for black tank HSI150 Yxz FLFE/X Y = number of rows, z = number of columns, X = wall thickness (mm)	
	Individual**
HSI150 1x1 FLFE/X, Y = 1, z = 1, X = individual	
	HSI150 1x1 FLFE/X*
HSI150 1x2 FLFE/X, Y = 1, z = 2, X = individual	
	HSI150 1x2 FLFE/X*
HSI150 1x3 FLFE/X, Y = 1, z = 3, X = individual	
	HSI150 1x3 FLFE/X*

* Article number, price and GTIN on request.

**Available as a package with multiple entries arranged horizontally or vertically, on request.

WALL INSERTS AND POLYMER FLANGE

POLYMER FLANGE FOR RETROFIT DOWELLING

Features and technical data:

- waterproof concrete stress class 1, stress class 2
- DIN 18533 W1.1-E, W1.2-E, W2.1-E
- flange in glass fibre reinforced polyamide with integrated spirit level
- form-closed surface seal made of EPDM
- high force absorption due to high-performance polymer, resistant to sea water
- core drill max. diameter 150 mm
- attachment elements made of stainless steel A4 (AISI 316L) including sealing rings against water ingress
- can be installed in container walls
- connection to system seal possible

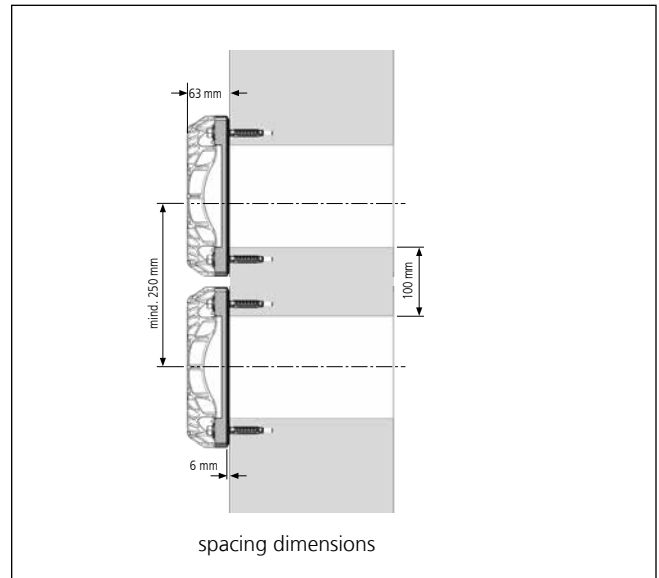
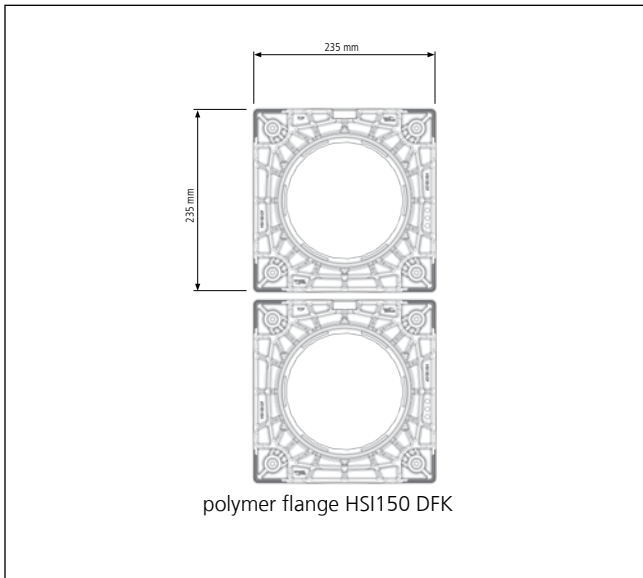

multiple configuration HSI150 DFK



core drill and dowel holes prepared for installation of HSI150 DFK



HSI150 DFK polymer flange with blind cover HSI150 DT

Cable entries 150

WALL INSERTS AND POLYMER FLANGE

HSI150 – POLYMER FLANGE			
Figure	Article code	Article number	GTIN
Polymer flange including attachment elements made of stainless steel A4 (AISI 316L) and sealing rings for concrete walls			
	HSI150 DFK	2118010020	4052487156264

ACCESSORIES			
Figure	Article code	Article number	GTIN
290 ml cartridge, colour grey, elastic sealant to optimize wall surface in combination with sealing flanges			
	EGO SMP805	5020050084	4052487238533

CLOSING COVER FOR EMPTY WALL INSERTS AND POLYMER FLANGES

Features and technical data:

- for pressure-tight closing of empty Wall inserts and polymer flanges HSI150
- cover made of ABS with TPE seal
- easy installation with bayonet catch
- gas-tight and watertight up to 2.5 bar

SYSTEM COVERS CABLE SEAL WITH HEAT SHRINK-FIT SLEEVE

Features and technical data:

- wide application range
- easy installation with bayonet catch
- including centring tape with HSI150 D1x80 WS and HSI150 D3x58 WS
- unused opening can be closed with blind plugs VS 32/34 or VS 58/60
- also available with cold shrink sleeves
- UV and ozone resistant
- transformer oil resistant



station entry: low-voltage cable sealed with HSI150 D1x80 WS



centring tape in system cover plugs of HSI150 D3x58 WS

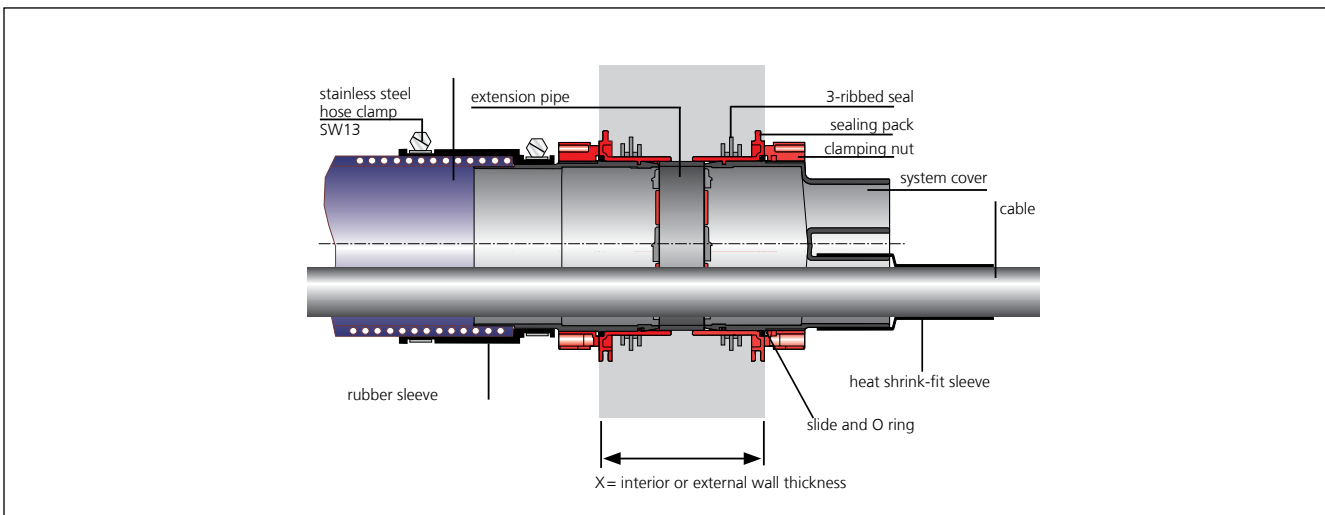

cross-section through wall

Cable entries 150

SYSTEM COVERS AND SYSTEM SEALS FOR CABLES

HSI150 – CLOSING COVER				
Figure	Item	Article code	Article number	GTIN
Transparent closing cover				
	Blind cover	HSI150 DT	2126010172	4052487193566

HSI150 – SYSTEM COVERS, HEAT SHRINK-FIT SLEEVE				
Figure	Application range cable/pipe diameter (mm)	Article code	Article number	GTIN
System cover with 1 socket, included 1 x hot shrink sleeve 1 x centring tape				
	25 – 78	HSI150 D1x80 WS	2101100010	4052487054966
System cover with 3 sockets, included 3 x hot shrink sleeve 1 x centring tape				
	22 – 56	HSI150 D3x58 WS	3030300082	4052487054997
System cover with 7 sockets, included 7x hot shrink sleeve				
	12 – 31	HSI150 D7x33 WS	3030300083	4052487197632

Designs with cold shrink sleeves, available on request.



Matching accessories such as blind plug for unused openings, centring tapes and repair sleeves are to be found from page 34 onwards.



SYSTEM COVERS AND SYSTEM SEALS FOR CABLES

SPLIT SYSTEM COVER FOR RETROFIT SEALING

Features and technical data:

- split seal for retrofit installation
- individual adjustment to to the diameter of the installed cable diameters on site
- labelled segment rings
- blind plugs are included with DG 3x24-54 and HSI150 DG 6x10-36
- transformer oil leak-tightness, tested over 90 days – KIWA Institute
- press plates made of polyamide 6.6 with 30% glass-fibre reinforcement
- screws and nuts made of stainless steel A4 (AISI 316L)
- pressure-tight up to 2.5 bar



low-voltage cables sealed with HSI150 DG 6x10-36



various installation stages for HSI150 DG 3x24-54



HSI150 DG: labelling of segments with the application range

Cable entries 150

SYSTEM COVERS AND SYSTEM SEALS FOR CABLES

HSI150 DG – SYSTEM COVER FOR RETROFIT INSTALLATION				
Figure	Application range cable/pipe OD (mm)	Article code	Article number	GTIN
Split system cover with 1 opening including split adapter ring				
	36 – 70	HSI150 DG 1x36-70	2102200020	4052487121064
Split system cover with 1 opening including split adapter ring				
	70 – 112	HSI150 DG 1x70-112	2102200030	4052487121071
Split system cover with 3 openings including split adapter ring and 3x blind plugs				
	24 – 54	HSI150 DG 3x24-54	2102200000	4052487055444
Split system cover with 6 openings including split adapter ring and 6x blind plugs				
	10 – 36	HSI150 DG 6x10-36	2102200010	4052487055451

Included per system cover HSI150 DG: GM lubricant stick, cutter knife, cleaning cloth.



Matching accessories such as installation toolkit are to be found from page 34 onwards.



SYSTEM COVERS AND SYSTEM SEALS FOR CABLES

SEGMENTO SEGMENTS FOR INSERTION IN SYSTEM COVERS HSI150 S3

Features and technical data:

- particularly flexible, gentle sealing
- for cables from diameter 5 to 31 mm
- individual clamping of segments
- easy and quick installation of segments that can be combined as necessary
- integrated torque control system
- simple to re-use and re-install
- all segment openings closed with blind plugs
- gas-tight and watertight up to 0.5 bar when installed on outside of the building



HSI150 – wall inserts fitted with SEGMENTO sealing for control cables in a transformer house



HSI150 SEGMENTO with integrated torque control system and blind plug



sealing of cables for street lighting with SEGMENTO

Cable entries 150

SYSTEM COVERS AND SYSTEM SEALS FOR CABLES

HSI150 – SEGMENTO			
Figure	Article code	Article number	GTIN
System cover for holding segments			
	HSI150 S3	3030300088	4052487062046
The violet segment application range for 2 cables, diameter 20 – 31 mm including 2 blind plugs			
	SEG 2x31	3030300180	4052487215442
The yellow segment application range for 3 cables, diameter 20 – 26 mm including 3 blind plugs			
	SEG 3x26	3030300181	4052487215459
The blue segment application range for 6 cables, diameter 15 – 21 mm including 6 blind plugs			
	SEG 6x21	3030300182	4052487215466
The orange segment application range for 8 cables, diameter 5 – 15 mm including 8 blind plugs			
	SEG 8x15	3030300183	4052487215473



Matching accessories such as the lubricant, assignment template and screwdriver for installation are to be found from page 34 onwards.





STANDARD PRESS SEAL WITH SEGMENTED RING TECHNOLOGY

Features and technical data:

- gas-tight and watertight up to 2.5 bar
- sealing width 40 mm
- split seal for retrofit installation
- segmented ring technology – individually adjustable to installed cable diameters on site
- EPDM rubber
- press plate made of stainless steel A2 (AISI 304L)
- stable 5 mm press plates



HRD150 SG 6x8-36 5 – individually adjustable to cable diameters

Cable entries 150

SYSTEM COVERS AND SYSTEM SEALS FOR CABLES

HRD SG – STANDARD PRESS SEAL WITH SEGMENTED RING TECHNOLOGY				
Figure	Cable diameter OD (mm)	Article code	Article number	GTIN
Standard press seal with 1 openings				
	12 – 75	HRD150 SG 1x12-75 b40 A2/EPDM55	2700103996	4052487063951
	75 – 110	HRD150 SG 1x75-110 b40 A2/EPDM55	2700103998	4052487063968
Standard press seal with 3 openings				
	22 – 54	HRD150 SG 3x22-54 b40 A2/EPDM55	2700104000	4052487000185
Standard press seal with 6 openings				
	8 – 35	HRD150 SG 6x8-35 b40 A2/EPDM55	2700105000	4052487000192
Standard press seal with 9 openings				
	6 – 25	HRD150 SG 9x6-25 b40 A2/EPDM55	2700106000	4052487000208
Standard press seal with 10 openings				
	4 x 8 – 30	HRD150 SG 4x8-30+6x4-16,5 b40 A2/EPDM55	2700106500	4052487000215
	6 x 4 – 16,5			

ACCESSORIES					
Figure	Width (mm)	Article code	Piece	Article number	GTIN
Split adapter ring for retrofit installation in HSI150 wall insert and HSI150 DFK					
	40	HRD150 SG/ARG	1	5060120155	4052487233330



You can find the suitable core drill hole sealant on page 87.





INDIVIDUAL PRESS SEAL FOR MICRO PIPES AND EMPTY CONDUITS

Features and technical data:

- gas-tight and watertight up to 2.5 bar
- sealing width: 60 mm
- in a closed design to seal micro pipes or empty conduits
- for core drillings/wall sleeves ID 150 mm
- in conjunction with adapter ring for use in the wall insert HSI150
- press plates, screws, nuts and washers made of stainless steel V2A (AISI 304L), optional V4A (AISI 316L)
- stable 5 mm press plates
- EPDM rubber

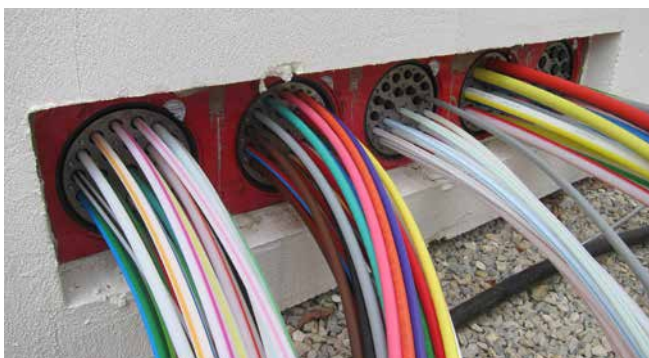

HSI150 wall insert fitted with HRD150 21x14 b60 A2/EPDM55 to seal micro pipes









You can find the suitable core drill hole sealant on page 87.



Cable entries 150

SYSTEM COVERS AND SYSTEM SEALS FOR CABLES

HRD 150 – INDIVIDUAL PRESS SEAL FOR MICRO PIPES						
Figure	Number of pipes	Arrangement (mm)	Micropipe diameter OD (mm)	Article code	Article number	GTIN
Core drill hole/wall sleeve ID 150 mm						
	24	2x 12/10	10	HRD150 24x10 b60 A2/EPDM55	2703270012	4052487185318
	15	3x 5/14	14	HRD150 15x14 b60 A2/EPDM55	2703270013	4052487193795
	21	3x 7/14	14	HRD150 21x14 b60 A2/EPDM55	2703270014	4052487194150
	14	2x 7/16	16	HRD150 14x16 b60 A2/EPDM55	2703270011	4052487185301
	12	3x 4/20	20	HRD150 12x20 b60 A2/EPDM55	2703270010	4052487185295
	4	4x 1/50	50	HRD150 4x50 b60 A2/ EPDM55	2703270009	4052487185288

* without optional plug for unconfigured openings
Other variants on request

BLINDPLUG B60 FOR PRESS SEALS					
Plug Ø (mm)	Article code	Piece	Article number	GTIN	
Plug for unconfigured openings					
10	GS10 b60 EPDM55	1	3030394586	4052487240031	
14	GS14 b60 EPDM55	1	3030410221	4052487240048	
16	GS16 b60 EPDM55	1	3030416685	4052487239844	
20	GS20 b60 EPDM55	1	3030314913	4052487240055	
50	GS50 b60 EPDM55	1	3030394582	4052487240062	

ACCESSORIES					
Figure	Width (mm)	Article code	Piece	Article number	GTIN
Split adapter ring for retrofit installation in HSI150 wall insert and HSI150 DFK					
	40	HRD150 SG/ARG	1	5060120155	4052487233330

SYSTEM COVERS WITH PUSH FIT SOCKET FOR SMOOTH CABLE DUCTS

Features and technical data:

- for smooth pipes and ducts
- easy and quick installation, no additional connecting components necessary
- economical solution
- compact design
- pressure-tight up to 0.5 bar depending on the cable duct used

SYSTEM COVERS WITH SLEEVE METHOD FOR SMOOTH AND CORRUGATED CABLE DUCTS

Features and technical data:

- can be used with for smooth and corrugated pipes and ducts
- patented clip ring technology for sealing corrugated pipes (please indicate pipe type and pipe manufacturer)
- mechanically stable, elastic connection using special sleeves and jubilee clips made of stainless steel A4 (AISI 316L)
- pressure-tight up to 0.5 bar depending on the cable duct used

SYSTEM COVER WITH COLD SHRINK-FIT METHOD FOR CORRUGATED CABLE DUCTS

Features and technical data:

- for corrugated pipes and ducts
- cold shrink-fit method, no tools necessary
- stress-free sealing for pressure-sensitive pipes
- pressure-tight up to 0.5 bar depending on the cable duct used



connection of a rigid cable duct DN 125 with HSI150 D 1x125 GSM





connection of corrugated pipes with sleeve method HSI150 MA168 WR





connection of corrugated pipes with cold shrink sleeves HSI150 D1x110 KS WR

Cable entries 150

SYSTEM COVERS FOR CONNECTING CABLE DUCTS

HSI150 – PUSH FIT SOCKET SYSTEM FOR SMOOTH DUCTS				
Figure	Duct OD (mm)	Article code	Article number	GTIN
System cover for duct connection				
	110	HSI150 D1x110 GSM	2101100105	4052487119443
	125	HSI150 D1x125 GSM	2101100115	4052487119450

HSI150 – SLEEVE METHOD FOR SMOOTH AND CORRUGATED DUCTS				
Figure	Duct OD (mm)	Article code	Article number	GTIN
System cover for smooth ducts				
	110	HSI150 MA110 GR	2126010110	4052487058346
	125	HSI150 MA125 GR	2126010125	4052487058360
	140	HSI150 MA145 GR	2126010140	4052487058377
	160	HSI150 MA168 GR	2126010000	4052487058292
System cover for corrugated ducts* including clip rings for Kabuflex				
	110	HSI150 MA110 WR	2126010113	4052487124980
	125	HSI150 MA125 WR	2126010007	4052487124973
	160	HSI150 MA168 WR	2126010001	4052487058308

* For corrugated duct connections, clip rings CR are additionally required (please specify duct type and manufacturer in your order). In addition 2 x profile sleeves from the corrugated duct manufacturer are required for each duct connection.

HSI150 – COLD SHRINK SLEEVES FOR CORRUGATED DUCTS				
Figure	Duct OD (mm)	Article code	Article number	GTIN
System cover for corrugated ducts				
	110	HSI150 D1x110 KS WR	2102100060	4052487055338
	125	HSI150 D1x125 KS WR	2102100070	4052487055352



Matching accessories such as replacement shrink sleeve are to be found from page 34 onwards.



SYSTEM COVERS FOR CONNECTION TO WALL INSERT HSI150

Features and technical data:

- for connecting the spiral hose Hateflex14150 to wall insert HSI150
- mechanically stable, elastic connection with system sleeve
- gas-tight and watertight up to 2.5 bar



pressure-tight connection to HSI150 wall inserts

CEMENT-COATED PIPE WITH SLEEVE FOR FLOOR ENTRY OF THE HATEFLEX SPIRAL HOSE

Features and technical data:

- waterproof concrete stress class 1, stress class 2
- for floor entry of the spiral hose Hateflex14150
- homogeneous bond with concrete due to special coating
- lightweight, break-resistant, inherently stable polymer pipe
- can be cut to floor level after completion of floor
- gas-tight and watertight up to 2.5 bar



side by side arrangement
2x KES150 MA ZVR150/500 on the installation fixture
KES FUBO-FIX AV

WALL INSERT

Features and technical data:

- waterproof concrete stress class 1, stress class 2
- for floor entry of spiral hose Hateflex14150
- mechanically stable, flexible connection with system sleeve
- system seal HSI150 can be connected on one side
- gas-tight and watertight up to 2.5 bar



SPIRAL HOSE

Features and technical data:



- pressure-tight flexible empty conduit system up to 2.5 bar (external pressure)
- empty conduit system can be built over
- high mechanical load capacity, compressive stress type 450 (DIN EN 61386-24)
- high flexibility, minimum bending radius 900 mm
- smooth inner surface for gentle cable feed
- empty conduit without sleeve available in lengths of up to 25 m; can be extended with adaptation with common cable ducts possible
- $\varnothing_i = 151 \text{ mm} \pm 1 \text{ mm}$
- $\varnothing_a = 166 \text{ mm} \pm 1 \text{ mm}$
- material: hard PVC/soft PVC



KES MA150 D and spiral hose Hateflex14150

Cable entries 150

CABLE ENTRY SYSTEM

KES150 MA – CABLE ENTRY SYSTEM			
Figure	Article code	Article number	GTIN
System cover for pressure-tight connection of spiral hose Hateflex14150 to wall insert HSI150			
	KES MA150 D	2125810000	4052487058070
Cement-coated wall sleeve (length 500 mm) with sleeve for floor entry of spiral hose Hateflex14150			
	KES MA150 ZVR150/500	2125502000	4052487139991
Wall insert including closing cover for connecting the system cover HSI150* to the end of spiral hose Hateflex14150			
	HSI150 1x1 KVB150	2125811000	4052487058087

* Other variants available, see www.hauff-technik.com



Matching accessories such as installation fixture and attachment for installation of floor entry are to be found from page 34 onwards.



SPIRAL HOSE (STANDARD LENGTHS)				
Figure	Length (m)	Article code	Article number	GTIN
	2	Hateflex14150/2000B	3030366925	4052487233163
	3	Hateflex14150/3000B	3030366901	4052487233118
	4	Hateflex14150/4000B	3030366902	4052487233101
	5	Hateflex14150/5000B	3030366904	4052487233095
	6	Hateflex14150/6000B	3030366909	4052487233057
	8	Hateflex14150/8000B	3030366912	4052487233033
	10	Hateflex14150/10000B	3030366915	4052487233231
	12	Hateflex14150/12000B	3030366918	4052487233217
	15	Hateflex14150/15000B	3030366921	4052487233194
	18	Hateflex14150/18000B	3030366923	4052487233187
	20	Hateflex14150/20000B	3030366924	4052487233170
	25	Hateflex14150/25000B	3030366893	4052487232869

Other Variants on demand.



Matching accessories such as pipe connection and connection collars or the installation toolset are to be found from page 34 onwards.



CABLE ENTRY SYSTEM

CONNECTION SET FOR CORE DRILLS/WALL SLEEVES

Features and technical data:

- waterproof concrete stress class 1, stress class 2
- for connecting the spiral hose Hateflex14150 to core drills or wall sleeves
- mechanically stable, elastic connection with system sleeve
- thick-walled, stable sleeve pipe
- gas-tight and watertight up to 2.5 bar

END STOP CABLE DUCT

Features and technical data:

- for cable seal at the end of the spiral hose Hateflex14150
- segmented ring technology for individual adjustment to the installed cable diameters on site
- interchangeable insert is installed after the cables have been laid
- entire cross-section of the empty conduit system is used when cables are laid



pressure-tight connection of spiral hose Hateflex14150 to wall insert HSI150 and end stop for the cable duct



sealing in soil at the end of spiral hose Hateflex14150 with the sealing set KES150 MA WE 160 SG 3x22-58 SET

Cable entries 150

CABLE ENTRY SYSTEM

KES150 MA – CABLE ENTRY SYSTEM

Figure	Article code	Article number	GTIN
Connection set for core drills/wall sleeve including two press seals to connect the spiral hose Hateflex14150 to core drills diameter 200 mm for max. wall thickness 500 mm *			
	KES150 MA KB SET	2125818500	4052487140409

* Other variants available, see www.hauff-technik.com.

KES150 MA – END STOP CABLE DUCT

Figure	Article code	Article number	GTIN
Sealing set KES150 MA WE including split interchangeable insert with segmented ring technology for the cable seal at the end of the spiral hose Hateflex14150: for 1 cable, diameter 48 – 83 mm or 3 cables, diameter 22 – 58 mm or 6 cables, diameter 8 – 36 mm (installation of sleeve prior to cable laying) including blind plug			
	KES150 MA WE160 SG 1x48-83 SET	2125817103	4052487164764
	KES150 MA WE160 SG 3x22-58 SET	2125817102	4052487164757
	KES150 MA WE160 SG 6x8-36 SET	2125817101	4052487164740

Sleeve for fitting with interchangeable insert WE 160-z/d for cable seal on spiral hose end of Hateflex14150 (installation prior to cable laying)

	KES150 MA160-172/140-163 WE	2125817100	4052487120937
---	-----------------------------	------------	---------------

Split interchangeable insert with segmented ring technology for installation in sleeve KES150 MA WE for sealing: of 1 cable, diameter 48 – 83 mm or 3 cables, diameter 22 – 58 mm or 6 cables, diameter 8 – 36 mm including blind plug

	WE160 SG 1x48-83	825817116	4052487164719
	WE160 SG 3x22-58	825817115	4052487164702
	WE160 SG 6x8-36	825817114	4052487164696

Split interchangeable insert for installation in sleeve KES150 MA WE production according to cable use
z = number of cables, d = cable diameter

	WE160 zxd	*	*
---	-----------	---	---

*Other variants available, see www.hauff-technik.com.











Matching accessories such as the toolset for installation are to be found from page 34 onwards.



Cable entries 150

ACCESSORIES

GENERAL ACCESSORIES			
Figure	Article code	Article number	GTIN
Flexible socket wrench (G); for buildings with perimeter insulation upto 100 mm (GD)			
	SLS 6G	5200010040	4052487233491
	SLS 6GD	5200010041	4052487233484
Lubricant 200g			
	GML	5020050010	4052487238564
Cable cleaner, content 1000 ml, fast and residue-free evaporation			
	KRMTX	5040020030	4052487238540
WALL INSERTS AND POLYMER FLANGE			
Figure	Article code	Article number	GTIN
Pressure discharge valve suitable for closing cover HSI150 DT for controlled release of accumulated water in a closed cable duct system			
	HSI150 DAE	2126010170	4052487193504
Hose extension for the pressure discharge valve HSI DAE (0,5 m)			
	HSI150 DAE SV	2126010171	4052487193559
Spacer set (2 x) to enlarge the axial spacing of the wall inserts to 250 mm. Enables block assembly HSI150 with HSI90			
	HSI AH40 SET2	3030300093	4052487220156
290 ml cartridge, colour grey, elastic sealant to optimize wall surface in combination with sealing flanges			
	EGO SMP805	5020050084	4052487238533
SYSTEM COVERS WITH SHRINK-FIT SLEEVE			
Figure	Article code	Article number	GTIN
To seal unused sockets Sealing plug for system cover HSI150 D7x33 and HSI150 D3x58			
	VS 32/34	3030300266	4052487216319
	VS 58/60	3030300267	4052487216326
For centering and fixing the cables into the system cover sockets for optimal shrinking. Centring tape set, comprising 3 x elastomer strips 30 x 430 mm			
	ZB EPDM50	5060120250	4052487233323

Cable entries 150



ACCESSORIES



SYSTEM COVERS WITH HEAT SHRINK-FIT SLEEVE			
Figure	Article code	Article number	GTIN
Replacement shrink sleeves for HSI150 D3x58 WS			
	WSM I200 2x75-22	5170030061	4052487233439
Replacement shrink sleeves for HSI150 D7x33 WS			
	WSM I150 2x43-12	5170030020	4052487232968
3-finger sleeve for system cover HSI150 D7x33 WS			
	3FM 1x44-13 3x16-4,2	5170060010	4052487233408
3-finger sleeve for system cover HSI150 D3x58 WS			
	3FM 1x71-22 3x26-9	5170060001	4052487233415
4-finger sleeve for system cover HSI150 D7x33 WS			
	4FM 1x55-21 4x20-7	5170060040	4052487233392
4-finger sleeve for system cover HSI150 D3x58 WS			
	4FM 1x80-25 4x27-9	5170060041	4052487233385
Repair sleeves for HSI150 D1x80 WS			
	WSMR I250 2x107-29	350070000	4052487010429
Repair sleeves for HSI150 D3x58 WS			
	WSMR I250 2x85-22	350040000	4052487010375
Repair sleeves for HSI150 D7x33 WS			
	WSMR I250 2x53-13	350030000	4052487010351

SYSTEM COVERS WITH COLD SHRINK-FIT SLEEVE			
Figure	Article code	Article number	GTIN
Replacement shrink sleeves for HSI150 D1x1110 KS WR			
	KSM I223 2x119-56	5170040004	4052487232982
Replacement shrink sleeves for HSI150 D1x1125 KS WR			
	KSM I240 2x154-76	5170040006	4052487232999
Hot-melt adhesive tape, cold-welding, length 3 m, width approx. 35 mm			
	Hatetherm Scapa 0485	316010000	4052487006668

Cable entries 150
ACCESSORIES

SPLIT SYSTEM COVER			
Figure	Article code	Article number	GTIN
Toolset for installation, comprising 1 torque wrench 4-20 Nm ¼-inch, 1 adapter for cordless screwdriver square end ¼ inch, 2 extensions 150 mm ¼ inch, 1 extension 100 mm ¼ inch, 1 wrench socket M6 SW 5 ¼ inch, 1 wrench socket M6 100 mm with ball head ¼ inch, 1 hexagon spanner M8 50 mm with ball head, ¼ inch			
	HSI150 DG/HRK SSG WKZ	5200010300	4052487233460

SYSTEM COVER SEGMENTO			
Figure	Article code	Article number	GTIN
SEGMENTO torque screwdriver (1.2 Nm) with acoustic signal generator			
	DSD	5200010236	4052487233477
SEGMENTO special lubricant 10 g			
	GMS	5020050021	4052487238557
SEGMENTO assignment template to determine the suitable segments according to the cable diameter			
	BSS	2300320000	4052487062244

CABLE ENTRY SYSTEME – FLOOR ENTRY			
Figure	Article code	Article number	GTIN
Installation fixture KES FUBO-FIX AV C-rack (length: 1100 mm) with 4 adjustable earth spikes			
	ES FUBO-FIX AV	1900500165	4052487165693
Fastening bow for diameter 160 mm suitable for fixing the KES150 MA ZVR150/500 at the installation fixture including attachment elements (side by side arrangement possible)			
	KES150 FUBO-FIX BB160	1900500167	4052487165716

Cable entries 150

ACCESSORIES

CABLE ENTRY SYSTEME			
Figure	Article code	Article number	GTIN
Connection sleeve for hose extension/connection Hateflex14150			
	KES150 MA150-172/150-172	2128020000	4052487058407
Connection sleeve to connect rigid cable ducts OD = 160 mm* to spiral hose Hateflex14150			
	KES150 MA160-172/140-163	2125812000	4052487058100
Connection sleeve to connect rigid cable ducts OD = 110 mm* to spiral hose Hateflex14150			
	KES150 MA160-172/140-163 AR111	2125814000	4052487058131
Connection sleeve to connect rigid cable ducts OD = 125 mm* to spiral hose Hateflex14150			
	KES150 MA160-172/140-163 AR126	2125813000	4052487058124
1 set of clip rings to stabilize the corrugated pipe* within the sleeve suitable for Kabulfex (please specify pipe type and manufacturer in your order)			
	CR110	1630500110	4052487134491
	CR125	1630500125	4052487134514
	CR160	1630500160	4052487134538
Rigid pipe section 440 mm projecting and OD = 160 mm with sleeve for connection to spiral hose Hateflex14150 (tight wall sealing in core drills in combination with an HRD press seal).			
	KES150 MA160-172/140-163 SET	2125818000	4052487058278
Spacer 1 x 2 to attach and position hose blocks with Hateflex14150 (can be combined with a simple connection system)			
	KES150 1x2 AH PP	3030361164	4052487233347
Toolset for pressure-tight strap assembly, comprising 1 torque 4-20 Nm, ¼ inch, 1 extension 150 mm, ¼ inch, 1 socket for hexagon spanner SW 13, ¼ inch, 1 socket for hexagon spanner SW 8, ¼ inch			
	KES MA WKZ SET	5200010302	4052487233453

* Additional clip rings CR are necessary to connect corrugated pipes.
In addition 2 x profile sleeves from the corrugated pipe manufacturer are required for each pipe connection.

WALL INSERTS AND POLYMER FLANGE

SINGLE WALL INSERT FOR SETTING IN CONCRETE

Features and technical data:

- waterproof concrete stress class 1, stress class 2
- system seal can be connected on one side
- minimum wall thickness 70 mm
- available in individual wall thicknesses ≥ 70 mm
- push fit socket frame system for block assembly on site
- pressure-tight cover
- pressure-tight up to 2 bar after concreting

DOUBLE WALL INSERT FOR SETTING IN CONCRETE

Features and technical data:

- waterproof concrete stress class 1, stress class 2
- connections to system seal possible on both sides
- minimum wall thickness 100 mm
- available for individual wall thicknesses ≥ 100 mm
- push fit socket frame system for block assembly, available ex stock
- pressure-tight cover on both sides
- pressure-tight up to 2 bar after concreting



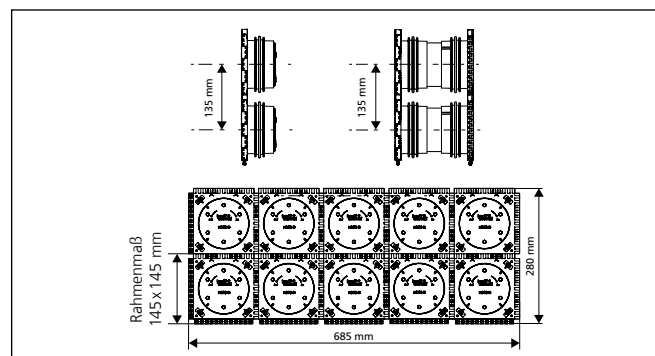

double wall insert HSI90 as block used in formwork



example 2x5 block for 200 mm wall thickness
article code HSI90 2x5 K2/200

Cable entries 90

WALL INSERTS AND POLYMER FLANGE

HSI90 – WALL INSERT	
Figure	Article code
Single wall insert, minimum wall thickness 70 mm	
	HSI90 1x1 K/X*
Double wall insert, minimum wall thickness 100 mm	
	HSI90 1x1 K2/X*

X = wall thickness (mm)

* You will find the article numbers and GTINs for the exact wall thickness at www.hauff-technik.com



Matching accessories such as the pin spanner to remove and install the system covers are to be found from page 54 onwards.



WALL INSERTS AND POLYMER FLANGE

SINGLE WALL INSERT WITH FOLDABLE RUBBER SLEEVE

Features and technical data:



- waterproof concrete stress class 1, stress class 2
- for setting in concrete and connecting corrugated cable ducts
- thanks to the folding sleeve method, no additional pipe components are required
- gas-tight and watertight to 0.5 bar

Cable entries 90

WALL INSERTS AND POLYMER FLANGE

NEW
coming soon

Cable entries

HSI90 KMA – WALL INSERT			
Figure	min. carrier pipe Ø_o (mm)	max. carrier pipe Ø_o (mm)	Article code
Single wall insert with foldable rubber sleeve for setting in concrete and connecting corrugated *cable ducts			
	55	65	HSI90 1x1 KMA65/X
	64	74	HSI90 1x1 KMA74/X
	84	94	HSI90 1x1 KMA94/X

X = wall thickness (mm)

* When connecting corrugated cable ducts, clip rings must be ordered separately. When ordering, please specify tube type and producer.

WALL INSERTS AND POLYMER FLANGE

SLANTED SINGLE WALL INSERT FOR SETTING IN CONCRETE

Features and technical data:

- waterproof concrete stress class 1, stress class 2
- for inclined building entry in all directions for an optimum bend radius
- can be customised for individual wall thickness
- system seal can be connected on one side
- packages can be created ex works (single row)
- 2.0 bar pressure-tight right after concreting

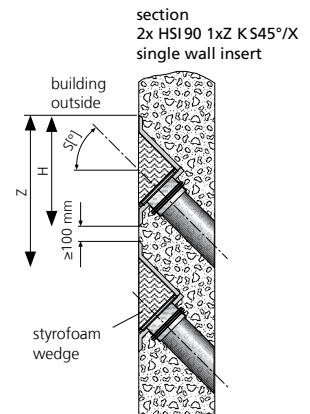

SLANTED DOUBLE WALL INSERT FOR SETTING IN CONCRETE

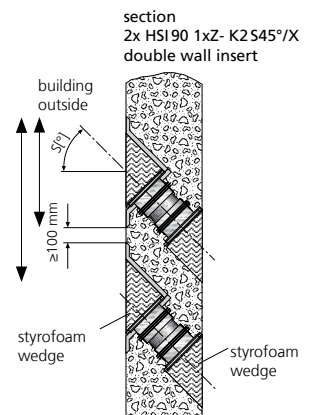

Features and technical data:

- waterproof concrete stress class 1, stress class 2
- for inclined building entry in all directions for an optimum bend radius
- can be customised for individual wall thickness
- system seal can be connected on both sides
- packages can be created ex works (single row)
- 2.0 bar pressure-tight right after concreting



Cable entries 90



WALL INSERTS AND POLYMER FLANGE

HSI90 1xz K S_°/X			
Figure	Installation angle	Minimum wall thickness (mm)	Article code
Slanted single wall insert S30°, z = number of columns			
	30°	190	HSI90 1xz K S30°/X
Slanted single wall insert S45°, z = number of columns			
	45°	200	HSI90 1xz K S45°/X

Article number, price and GTIN on request..

X = wall thickness (mm)

Minimum thickness of 200 mm of concrete cover as per WU-Richtlinie (Merkblatt H10) is met in case of wall inserts HSI90 K S30° only by a minimum wall thickness of 300 mm (S45° – 350 mm).

HSI90 1xz K2 S_°/X			
Figure	Installation angle	Minimum wall thickness (mm)	Article code
Slanted double wall insert S30°, z = number of columns			
	30°	200	HSI90 1xz K2 S30°/X
e.g. HSI90 1x3 K2 S45°			
Slanted double wall insert S45° z = number of columns			
	45°	210	HSI90 1xz K2 S45°/X
e.g. HSI90 1x3 K2 S45°			

X = wall thickness (mm)

Article number, price and GTIN on request..

Minimum thickness of 200 mm of concrete cover as per WU-Richtlinie (Merkblatt H10) is met in case of wall inserts HSI90 K2 S30° only by a minimum wall thickness of 298 mm (S45° – 335 mm; S60° – 360 mm).

WALL INSERTS AND POLYMER FLANGE

POLYMER FLANGE FOR SUBSEQUENT DOWELLING

Features and technical data:

- waterproof concrete stress class 1, stress class 2
- DIN 18533 W1.1-E, W1.2-E, W2.1-E
- with integrated spirit level
- tried and tested solution for use in fresh concrete composite systems
- one-sided connection option for system sealing (e.g. cable conduit connection or cable sealing)
- can be installed in container walls
- form-closed surface seal
- core drill max. diameter 100 mm
- gastight and watertight up to 2.5 bar

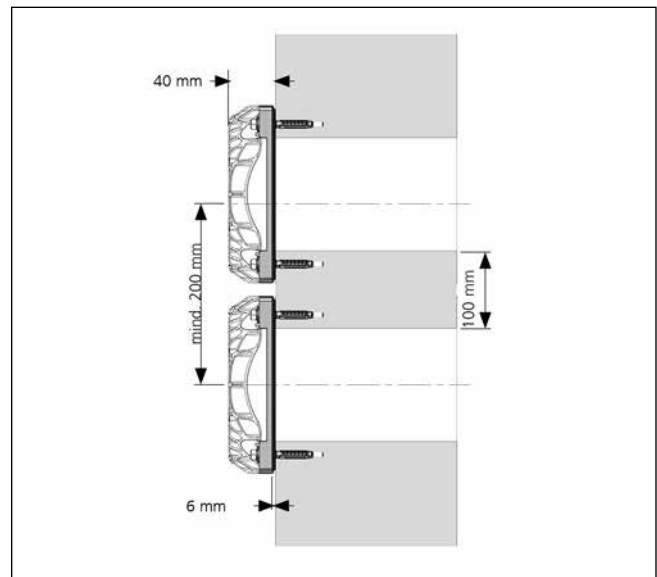
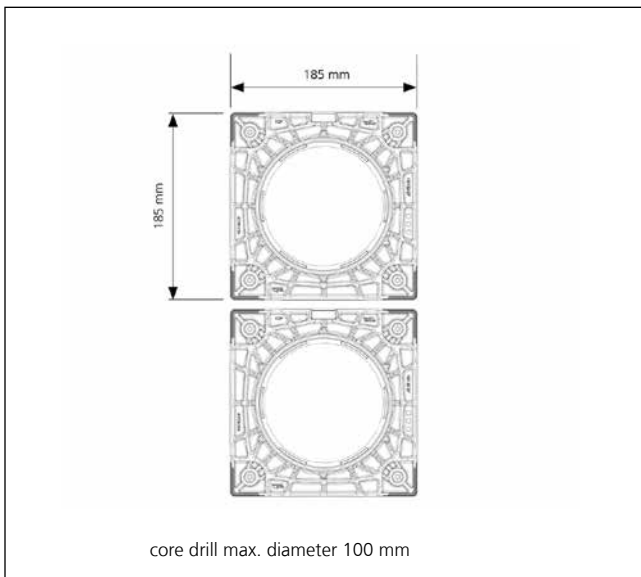



polymer flange HSI90 DFK

Cable entries 90

WALL INSERTS AND POLYMER FLANGE



HSI90 – POLYMER FLANGE			
Figure	Article code	Article number	GTIN
Polymer flange including attachment elements made of stainless steel A4 (AISI 316L) and sealing rings for concrete walls			
	HSI90 DFK	3030466887	4052487240529

ACCESSORIES			
Figure	Article code	Article number	GTIN
290 ml cartridge, colour grey, elastic sealant to optimize wall surface in combination with sealing flanges			
	EGO SMP805	5020050084	4052487238533

Cable entries

SYSTEM COVERS FOR CABLES

COVER FOR EMPTY WALL INSERTS AND ALUMINIUM FLANGE

Features and technical data:

- for pressure-tight sealing of wall inserts that are not in use and polymer flanges HSI90
- closing cover made of ABS with seal in TPE
- easy installation with bayonet catch
- gas-tight and watertight up to 2.0 bar

SYSTEM COVER CABLE SEAL WITH HEAT SHRINK-FIT SLEEVE

Features and technical data:

- wide application range
- easy installation with bayonet catch
- including centring tape at HSI90 D1x75 WS und KS
- unused opening can be closed off with blind plugs VS 20, VS 32/34 respectively
- also available in cold shrink sleeves
- UV and ozone resistant
- transformer oil resistant



station entry: low-voltage cable sealed
HSI90 D1x75 WS and HSI90
D3x32 WS

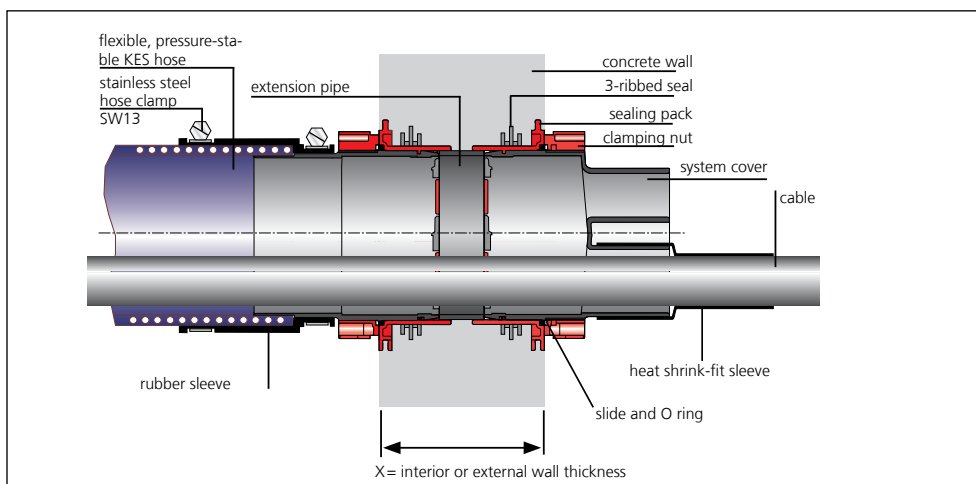

cross-section of wall

PRESS SEAL FOR RETROFIT SEALING



Features and technical data:

- Split seal for retrofit installation
- manufactured to the millimetre as appropriate for the prevailing installation conditions and in accordance with customer specifications
- suitable for one or more cables
- press seal with overlapping flange
- gas-tight and watertight up to 2,5 bar

Cable entries 90

SYSTEM COVERS FOR CABLES

HSI90 – CLOSING COVER				
Figure	Item	Article code	Article number	GTIN
Closing cover				
	Blind cover	HSI90 D	2205010000	4052487060851

HSI90 – SYSTEM COVER HEAT SHRINK-FIT SLEEVE				
Figure	Application range cable/pipe diameter (mm)	Article code	Article number	GTIN
System covers with 1 socket including 1 x thermal sleeve 1 x centring tape				
	25 – 72	HSI90 D1x75 WS	3030300089	4052487060936
System covers with 3 sockets including 7 x thermal sleeves				
	12 – 30	HSI90 D3x32 WS	3030300090	4052487060899
System covers with 6 sockets including 7 x thermal sleeves				
	8 – 18	HSI90 D6x20 WS	3030300091	4052487060912

Types with cold shrink sleeves available on request.

HRD – INDIVIDUAL PRESS SEAL			
Figure	Article code	Article number	GTIN
Seal width 60 mm, split, with overlapping flange, z = number of cables, d = cable diameter			
	HRD94/83 GF zxd b60 A2/EPDM55	*	*

* Article number, price and GTIN on request.

 Matching accessories such as blind plug for unused openings, centring tapes and repair sleeves are to be found from page 54 onwards.



SYSTEM COVERS FOR CONNECTING CABLE DUCTS

SYSTEM COVERS WITH SLEEVE METHOD FOR SMOOTH AND CORRUGATED CABLE DUCTS

Features and technical data:

- to be used with smooth and corrugated ducts
- patented clip ring technology for sealing corrugated ducts (please indicate duct type and duct manufacturer)
- mechanically stable, elastic connection using special sleeves and tightening straps made of stainless steel A4 (AISI 316L)
- with stainless steel jubilee clips
- pressure-tight up to 0.5 bar, depending on the cable duct used

SYSTEM COVER WITH COLD SHRINK-FIT METHOD FOR CORRUGATED CABLE DUCTS

Features and technical data:

- for corrugated ducts
- cold shrink-fit method without tools
- stress-free sealing for pressure-sensitive ducts
- pressure-tight up to 0.5 bar, depending on the cable duct used



assembly of double wall insert HSI90 before concreting





HSI90 after concreting: empty ducts are installed subsequently



connection of corrugated ducts HSI90 D1x75 KS WR

Cable entries 90

SYSTEM COVERS FOR CONNECTING CABLE DUCTS

HSI90 – SLEEVE METHOD FOR SMOOTH AND CORRUGATED DUCTS				
Figure	Duct OD (mm)	Article code	Article number	GTIN
System cover for smooth ducts				
	75	HSI90 M75 GR	2206040015	4052487129145
	90	HSI90 MA90 GR	2206040018	4052487060981
	110	HSI90 MA110 GR	2206040020	4052487060998
System cover for corrugated ducts* including clip rings for Kabuflex				
	90	HSI90 MA90 WR	2206040025	4052487124997
	110	HSI90 MA110 WR	2206040029	4052487125000

* For corrugated duct connections, clip rings CR are additionally required (please specify duct type and manufacturer in your order). In addition 2 x profile sleeves from the corrugated duct manufacturer are required for each duct connection.

HSI90 – COLD SHRINK SLEEVES FOR CORRUGATED DUCTS				
Figure	Duct OD (mm)	Article code	Article number	GTIN
System cover for corrugated ducts				
	75	HSI90 D1x75 KS WR	2206040001	4052487060943



Matching accessories such as replacement shrink-fit sleeves are to be found from page 54 onwards.



CABLE ENTRY SYSTEM

SYSTEM COVERS FOR CONNECTION TO WALL INSERT HSI90

Features and technical data:

- for connecting the spiral hose Hateflex14090 to wall insert HSI90
- mechanically stable, elastic connection with system sleeve
- gas-tight and watertight up to 2.0 bar



KES MA90 D – connection to the HSI90 wall insert

CEMENT-COATED PIPE WITH SLEEVE FOR FLOOR ENTRY OF THE HATEFLEX SPIRAL HOSE

Features and technical data:

- waterproof concrete stress class 1, stress class 2
- for floor entry of the spiral hose Hateflex14090
- homogeneous bond with concrete due to special coating
- lightweight, break-resistant, inherently stable polymer pipe
- can be cut to floor level after completion of floor
- gas-tight and watertight up to 2.5 bar



side by side arrangement
2x KES90 MA ZVR100/500 on
the installation fixture
KES FUBO-FIX AV

WALL INSERT

Features and technical data:

- waterproof concrete stress class 1, stress class 2
- for floor entry of spiral hose Hateflex14090
- mechanically stable, flexible connection with system sleeve
- system seal HSI90 can be connected on one side
- gas-tight and watertight up to 2.0 bar



HSI901x1 KVB90 as wall and
floor entry of Hateflex spiral hose
14090

SPIRAL HOSE

Features and technical data:



- pressure-tight flexible empty conduit system up to 2.5 bar (external pressure)
- empty conduit system can be built over
- high mechanical load capacity, compressive stress type 450 (DIN EN 61386-24)
- high flexibility, minimum bending radius 900 mm
- smooth inner surface for gentle cable feed
- empty conduit without sleeve available in lengths of up to 25 m;
can be extended with adaptation with common cable ducts possible
- $\varnothing_i = 91 \text{ mm} \pm 1 \text{ mm}$
- $\varnothing_a = 104 \text{ mm} \pm 1 \text{ mm}$
- material: hard PVC/soft PVC



KES MA90 D and
spiral hose Hateflex14090

Cable entries 90

CABLE ENTRY SYSTEM

KES MA90 – CABLE ENTRY SYSTEM			
Figure	Article code	Article number	GTIN
System cover for pressure-tight connection of spiral hose Hateflex 14090 to wall insert HSI90			
	KES MA90 D	2225810000	4052487061377
Cement-coated wall sleeve (length 500 mm) with sleeve for floor entry of Hateflex spiral hose 14090			
	KES MA90 ZVR100/500	2125502003	4052487164894
Wall insert including closing cover for connecting the system cover HSI90* to the end of spiral hose Hateflex14090			
	HSI90 1x1 KVB90	2225811000	4052487061384

* Other variants available, see www.hauff-technik.com



Matching accessories such as installation fixture and attachment for installation of floor entry are to be found from page 54 onwards.



SPIRAL HOSE (STANDARD LENGTHS)				
Figure	Length (m)	Article code	Article number	GTIN
	1,5	Hateflex14090/1500B	2230000150	4052487061513
	2	Hateflex14090/2000B	3030366927	4052487233156
	3	Hateflex14090/3000B	3030366899	4052487233125
	6	Hateflex14090/6000B	3030366907	4052487233064
	8	Hateflex14090/8000B	3030366910	4052487233040
	10	Hateflex14090/10000B	3030366913	4052487233248
	12	Hateflex14090/12000B	3030366916	4052487233224
	15	Hateflex14090/15000B	3030366919	4052487233200
	25	Hateflex14090/25000B	3030366890	4052487233132

Other variants on demand.



Matching accessories such as pipe connection and connection sleeves or the installation toolset are to be found from page 54 onwards.



CABLE ENTRY SYSTEM

CONNECTION SET FOR CORE DRILLS/WALL SLEEVES

Features and technical data:

- waterproof concrete stress class 1, stress class 2
- for connecting the spiral hose Hateflex14090 to core drills or wall sleeve
- mechanically stable, elastic connection with system sleeve
- thick-walled, stable sleeve pipe
- gas-tight and watertight up to 2.5 bar

END STOP CABLE DUCT

Features and technical data:

- for cable seal at the end of the spiral hose Hateflex14090
- segmented ring technology for individual adjustment to the installed cable diameters on site
- interchangeable insert is installed after the cables have been laid
- entire cross-section of the empty conduit system is used when cables are laid



pressure-tight connection of spiral hose Hateflex14090 to wall insert HSI90 and end stop for the cable duct







sealing set KES90 MA WE100 SG 1x18-65 SET for cable sealing at end of cable duct

Cable entries 90

CABLE ENTRY SYSTEM

KES MA90 – CABLE ENTRY SYSTEM			
Figure	Article code	Article number	GTIN
Connection set for core drill hole/wall sleeve including two press seals for connecting the Hateflex spiral hose 14090 to core drills diameter 150 mm for max. wall thickness 500 mm*			
	KES90 MA KB SET	2125818504	4052487164900

* Other variants available, see www.hauff-technik.com

KES90 MA – CABLE ENTRY SYSTEM			
Figure	Article code	Article number	GTIN
Sealing set KES90 MA WE including interchangeable insert WE 100 with segmented ring technology for sealing cables at the end of the spiral hose Hateflex14090 for: 1 cable, diameter 18 – 65 mm including blind plug			
	KES90 MA90-102/90-102 WE100 SG 1x18-65	2225817101	4052487164726
Sleeve to be used with interchangeable insert WE 100 zxd for sealing cables on end of spiral hose Hateflex14090 (installation before cables are pulled through)			
	KES90 MA90-102/90-102 WE	2225817100	4052487120951
Split interchangeable insert with segmented ring technology for installation in sleeve KES90 MA WE, 1 = number of cables, 18 – 65 = cable diameter, included blind plug			
	WE100 SG 1x18-65	825817112	4052487159166
Split interchangeable insert for installation in sleeve KES90 MA WE production acc. to cable use z = number of cables, d = cable diameter			
	WE100 zxd	*	*

* Article number, price and GTIN on request.







Matching accessories such as the toolset for installation are to be found from page 54 onwards.





Cable entries 90

ACCESSORIES

GENERAL ACCESSORIES			
Figure	Article code	Article number	GTIN
Flexible socket wrench (G); for buildings with perimeter insulation upto 100 mm (GD)			
	SLS 6G	5200010040	4052487233491
	SLS 6GD	5200010041	4052487233484
Lubricant 200g			
	GML	5020050010	4052487238564
Cable cleaner, content 1000 ml, fast and residue-free evaporation			
	KRMTX	5040020030	4052487238540

WALL INSERTS AND ALUMINIUM FLANGE			
Figure	Article code	Article number	GTIN
290 ml cartridge, colour grey, elastic sealant to optimize wall surface in combination with sealing flanges			
	EGO SMP805	5020050084	4052487238533



SYSTEM COVERS WITH SHRINK-FIT SLEEVE			
Figure	Article code	Article number	GTIN
To seal unused sockets, sealing plug for system cover HSI90 D6x20 and HSI90 D3x32			
	VS 20	3030300265	4052487216302
	VS 32/34	3030300266	4052487216319
For centering and fixing the cables into the system cover sockets for optimal shrinking. Centring tape set, comprising 3 x elastomer strips 30 x 430 mm			
	ZB EPDM50	5060120250	4052487233323

Cable entries 90
ACCESSORIES







SYSTEM COVERS WITH HEAT SHRINK-FIT SLEEVE			
Figure	Article code	Article number	GTIN
Replacement shrink sleeves for HSI90 D1x75 WS			
	WSM I200 2x92-25	5170030090	4052487233422
Replacement shrink sleeves for HSI90 D3x32 WS			
	WSM I150 2x43-12	5170030020	4052487232968
Replacement shrink sleeves for HSI90 D6x20 WS			
	WSM I150 2x25-8	5170030005	4052487233446
3-finger sleeve for HSI90 D3x32 WS			
	3FM 1x44-13 3x16-4,2	5170060010	4052487233408
4-finger sleeve for HSI90 D3x32 WS			
	4FM 1x55-21 4x20-7	5170060040	4052487233392
Repair sleeves for HSI90 D1x75 WS			
	WSMR I250 2x85-22	350040000	4052487010375
Repair sleeves for HSI90 D3x32 WS			
	WSMR I250 2x53-13	350030000	4052487010351
Repair sleeves for HSI90 D6x20 WS			
	WSMR I250 2x34-10	350010000	4052487010337

SYSTEM COVERS WITH COLD SHRINK-FIT SLEEVE			
Figure	Article code	Article number	GTIN
Replacement shrink sleeves for HSI90 D1x75 KS			
	KSM I235 2x93-38	5170040001	4052487232975
Hot-melt adhesive tape, cold-welding, length 3 m, width approx. 35 mm			
	Hatetherm Scapa 0485	316010000	4052487006668

Cable entries 90
ACCESSORIES

CABLE ENTRY SYSTEME – FLOOR ENTRY			
Figure	Article code	Article number	GTIN
Installation device KES FUBO-FIX AV C-rack (length 1100 mm) with adjustable earth spikes			
	ES FUBO-FIX AV	1900500165	4052487165693
Fastening bow for diameter 110 mm suitable for fixing the KES90 MA ZVR100/500 installation fixture including attachment elements (side by side arrangement possible)			
	KES90/110 FUBO-FIX BB110	1900500166	4052487165709

Cable entries 90
ACCESSORIES

CABLE ENTRY SYSTEME			
Figure	Article code	Article number	GTIN
Connection sleeve for hose extension of spiral hose Hateflex14090			
	KES90 MA90-102/90-102	2209060100	4052487061186
Connection sleeve for connecting rigid cable ducts OD = 90 mm* to spiral hose Hateflex14090			
	KES90 MA70-90/90-110	2225814000	4052487061414
Connection sleeve for connecting rigid cable ducts OD = 110 mm* to spiral hose Hateflex14090			
	KES110 MA110-125/90-113	0825814000	4052487015806
1 piece of clip ring to stabilize the corrugated pipe within the sleeve suitable for Kabuflex (please specify pipe type and manufacturer in your order)			
	CR90	1630500090	4052487134484
	CR110	1630500110	4052487134491
Rigid pipe section 440 mm projecting pipe* and OD = 90 mm with sleeve for connection to spiral hose Hateflex14090 (tight wall sealing in core drills in combination with a standard press seal).			
	KES90 MA110-125/90-113 SET	2225818000	4052487061452
Spacer e.g. 2 x 4 for fixing and positioning of hose packages with Hateflex14090 (other variants available)			
	KES90 2x4 AH	5010060046	4052487233699
Toolset for pressure-tight tension strap installation, comprising 1 torque 4 – 20 Nm, ¼ inch, 1 extension 150 mm, ¼ inch, 1 socket for hexagon spanner SW 13, ¼ inch, 1 socket for hexagon spanner SW 8, ¼ inch			
	KES MA WKZ SET	5200010302	4052487233453

* Additional clip rings CR are necessary to connect corrugated pipes.
In addition 2 x profile sleeves from the corrugated pipe manufacturer are required for each pipe connection.

CABLE ENTRY AND PRESS SEAL

CABLE ENTRY

Features and technical data

- for sealing of one or more cables/micropipes in the container floors and walls
- sealing of micropipes in combination with a suitable press seal*
- fast sealing of carrier pipe with cold or heat shrink method
- high flexibility on site due to large application range
- fast and easy installation
- high-grade polycarbonate material
- robust Pg Thread

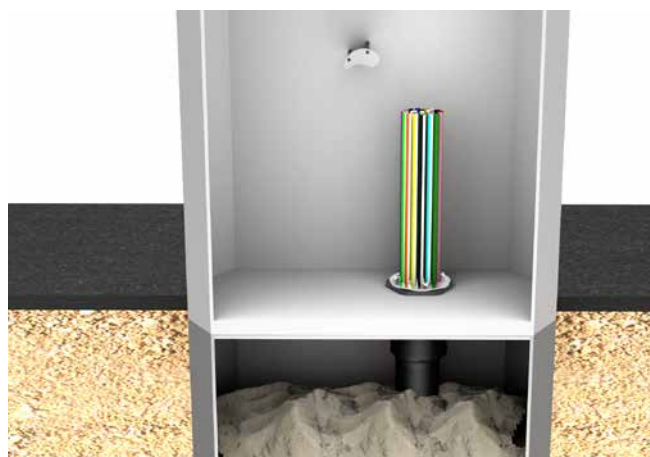
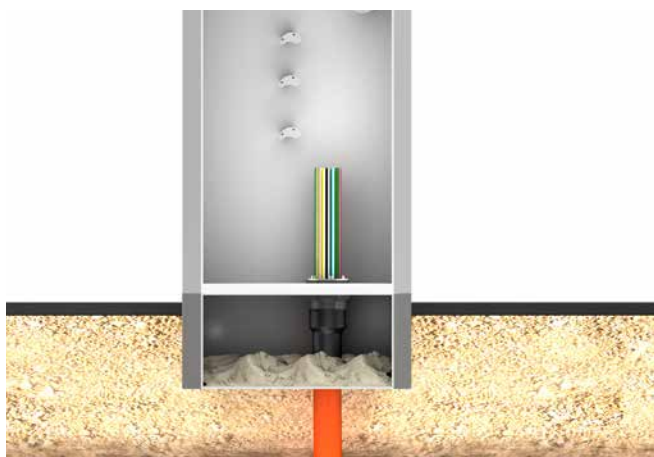

PRESS SEAL





Features and technical data

- for sealing micropipes and cables with OD 7 mm or 12mm
- sealing width 30 mm
- pressure tight up to 1 bar
- rust-free stainless steel V2A
- EPDM
- simple installation



Cable entries

CABLE ENTRY AND PRESS SEAL

KV PG – CABLE ENTRY INCLUDING SHRINK SLEEVE(S), MAXIMUM THICKNESS OF THE HOUSING WALL: 20 MM							
Figure	Housing bore hole ID (mm)	No of cables/ micropipes	Application range micropipe/cable diameter OD (mm)		Article code	Article number	GTIN
			min.	max.			
Cable screw connection Heat shrink method							
	60	1	16	56	KV PG48 WS	334020000	4052487009546
	76	1	22	75	KV PG68 WS*	334010000	4052487009515
	76	4	9	27	KV PG68 WS 4F	334010100	4052487009539
Cable screw connection Cold shrink method							
	60	1	24	56	KV PG48 KS	334020090	4052487009553
	76	1	38	93	KV PG68 KS	0334010090	4052487009522

*Micropipes can be sealed with a press seal HRD68 F b30.

HRD68 F zxd b30 A2/EPDM55 PRESS SEAL						
Figure	Opening diameter ID (mm)	No of cables/ micropipes	Micro-pipe/cable diameter OD (mm)	Article code	Article number	GTIN
Press seal for micropipes and/or cables						
	68	24	7	HRD68 F 24x7 b30 A2/ EPDM55	2702226860	4052487066167
	68	9	12	HRD68 F 9x12 b30 A2/ EPDM55	2702226810	4052487066112

Other layout options on request.

STANDARD WALL SLEEVES

BELLMOUTH WALL SLEEVE

Features and technical data:

- waterproof concrete stress class 1, stress class 2
- frame connection system for easy creation of packages on site – compatible with all three sizes
- easy adjustment to the wall thickness on site
- integrated bellmouth shape protects the cables from damage
- blind plate ensures pressure tightness up to 1 bar after concreting
- comfortable breaking through thanks to trisection division of the blind plate
- sealing flange for the processing of polymer modified bituminous thick coatings
- middle flange serves as water barrier
- suitable for standard press seals
- lugs for tie wire
- nail lugs with break protection for easy adjustment in the formwork

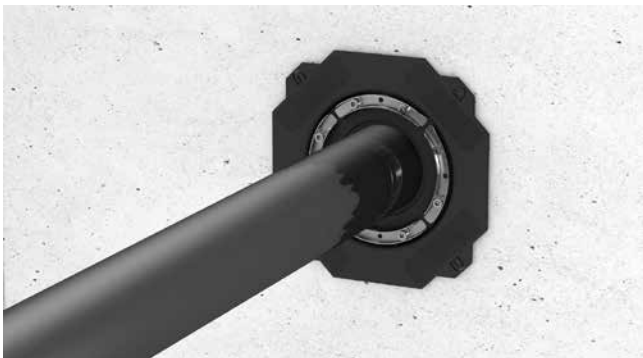

BWS 200/200 with HSD200 SSG 1x1 10-162 b40 A2/EPDM55

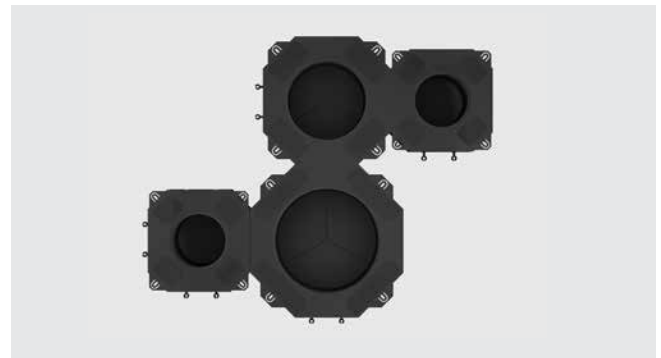

BWS as a package

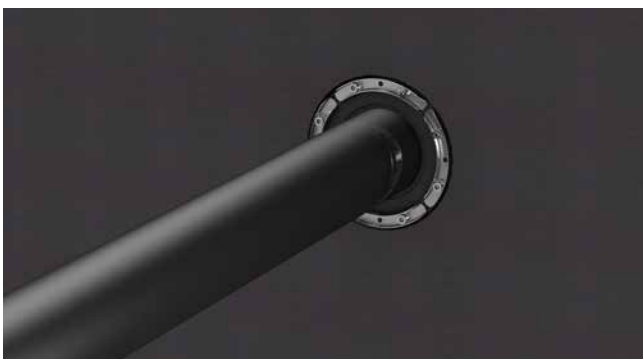



BWS with polymer modified bituminous thick coating



BWS as a package with standard press seals

Wall sleeves

STANDARD WALL SLEEVES

BWS							
Figure	Wall sleeve ID, d_1 (mm)	Wall sleeve ID, d_2 (mm)	Sealing flange OD, d_3 (mm)	Minimum wall thickness, d_4 (mm)	Article code	Article number	GTIN
	100	110	200x200	120	BWS100/110	827030100	4052487196024
	150	160	250x250	120	BWS150/160	827030150	4052487196031
	200	200	300x300	120	BWS200/200	827030200	4052487196048

Wall sleeves

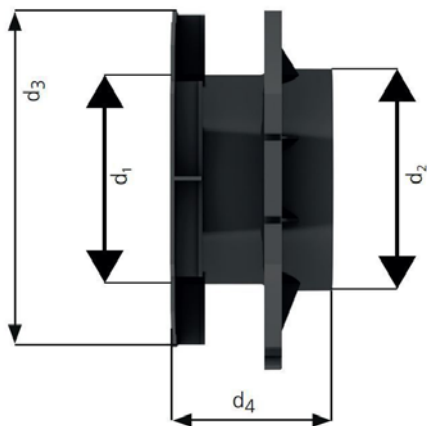

UNIVERSAL WALL SLEEVE FOR ALL WALL TYPES

Features and technical data:

- waterproof concrete stress class 1, stress class 2
- DIN 18533 W1.1-E, W1.2-E, W2.1-E
- with integrated sealing flange for the processing of polymer modified bituminous thick coatings
- can be used in all wall types including element constructions
- break-resistant
- for installation flush with the formwork
- closed ready for installation



concreted UFR with PMBC



UFR in formwork

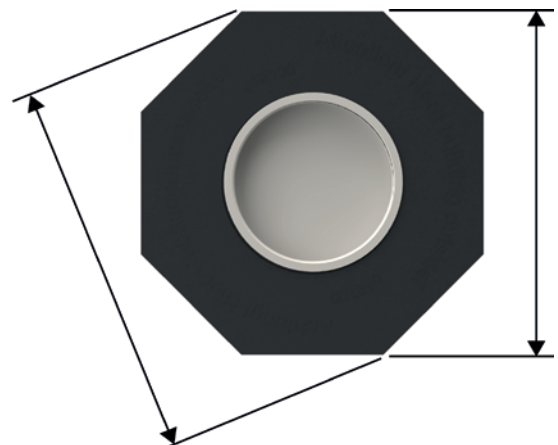
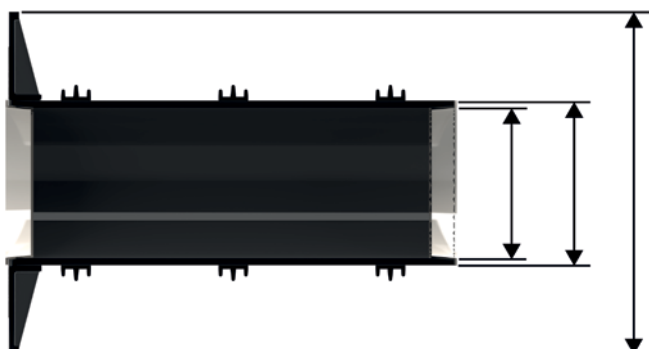

Wall sleeves

STANDARD WALL SLEEVES

UFR – UNIVERSAL WALL SLEEVE					
Figure	Length (mm)	Article code	Pieces in packing unit	Article number	GTIN
Universal wall sleeve 100, wall sleeve ID, D1 100mm, wall sleeve OD, D2 110mm, sealing flange OD, D4 210mm, sealing flange OD D3 227mm					
	200	UFR100/200	1	3030300244	4052487216098
			5		4052487221177
	240	UFR100/240	1	3030300245	4052487216104
			5		4052487221184
	250	UFR100/250	1	3030300246	4052487216111
			5		4052487221191
	300	UFR100/300	1	3030300247	4052487216128
			5		4052487221207
	365	UFR100/365	1	3030300248	4052487216135
			5		4052487221214
	400	UFR100/400	1	3030300249	4052487216142
			5		4052487221221
	500	UFR100/500	1	3030300250	4052487216159
			5		4052487221238
Universal wall sleeve 150, wall sleeve ID, D1 150mm, wall sleeve OD, D2 163mm, sealing flange OD, D4 260mm, sealing flange OD D3 282mm					
	200	UFR150/200	1	3030300251	4052487216166
			5		4052487221245
	240	UFR150/240	1	3030300252	4052487216173
			5		4052487221252
	250	UFR150/250	1	3030300253	4052487216180
			5		4052487221269
	300	UFR150/300	1	3030300254	4052487216197
			5		4052487221276
	365	UFR150/365	1	3030300255	4052487216203
			5		4052487221283
	400	UFR150/400	1	3030300256	4052487216210
			5		4052487221290
	500	UFR150/500	1	3030300257	4052487216227
			5		4052487221306

Customised lengths available.

Wall sleeves

STANDARD WALL SLEEVES

UFR – UNIVERSAL WALL SLEEVE					
Figure	Length (mm)	Article code	Pieces in packing unit	Article number	GTIN
Universal wall sleeve 200, wall sleeve ID, D1 200mm, wall sleeve OD, D2 214mm, sealing flange OD, D4 311mm, sealing flange OD D3 336mm					
	200	UFR200/200	1	3030300258	4052487216234
			5		4052487221313
	240	UFR200/240	1	3030300259	4052487216241
			5		4052487221320
	250	UFR200/250	1	3030300260	4052487216258
			5		4052487221337
	300	UFR200/300	1	3030300261	4052487216265
			5		4052487221535
	365	UFR200/365	1	3030300262	4052487216272
			5		4052487221344
	400	UFR200/400	1	3030300263	4052487216289
			5		4052487221351
	500	UFR200/500	1	3030300264	4052487216296
			5		4052487221368
Universal wall sleeve 250, wall sleeve ID, D1 250mm, wall sleeve OD, D2 264mm, sealing flange OD, D4 384mm, sealing flange OD D3 416mm					
	200	UFR250/200	1	2800250200	4052487155526
	240	UFR250/240		2800250240	4052487155540
	250	UFR250/250		2800250250	4052487155557
	300	UFR250/300		2800250300	4052487155564
	365	UFR250/365		2800250365	4052487155571
	400	UFR250/400		2800250400	4052487155588
	500	UFR250/500		2800250500	4052487155625

Customised lengths available.

Wall sleeves

STANDARD WALL SLEEVES

UFR – UNIVERSAL WALL SLEEVE					
Figure	Length (mm)	Article code	Pieces in packing unit	Article number	GTIN
Universal wall sleeve 300, wall sleeve ID, D1 300mm, wall sleeve OD, D2 316mm, sealing flange OD, D4 436mm, sealing flange OD D3 472mm					
	200	UFR300/200	1	2800030200	4052487154031
	240	UFR300/240		2800030240	4052487154048
	250	UFR300/250		2800030250	4052487154055
	300	UFR300/300		2800030300	4052487154062
	365	UFR300/365		2800030365	4052487154079
	400	UFR300/400		2800030400	4052487154086
	500	UFR300/500		2800030500	4052487154123

Customised lengths available.

Wall sleeves

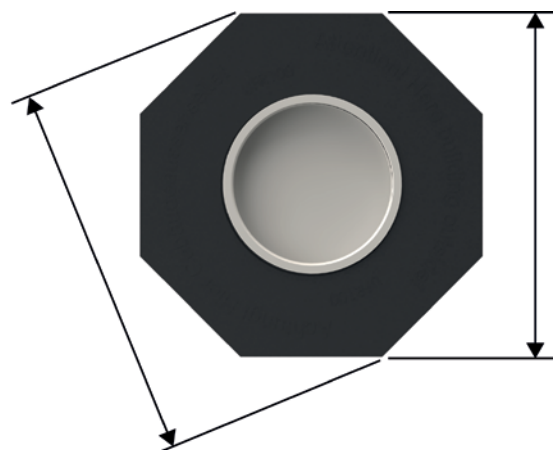
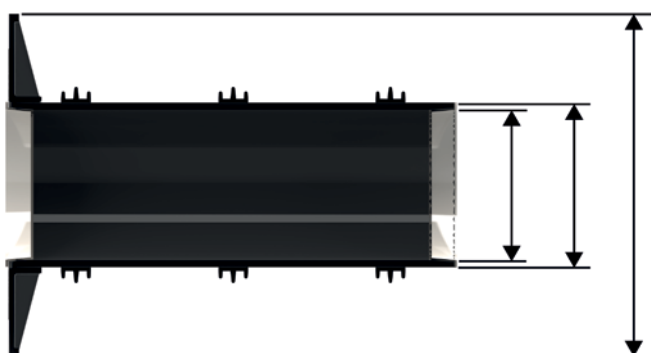

STANDARD WALL SLEEVES

CONNECTION WALL SLEEVE

Features and technical data:

- waterproof concrete stress class 1, stress class 2
- DIN 18533 W1.1-E, W1.2-E, W2.1-E
- blind seal ready for installation, watertight straight after concreting
- with integrated sealing flange for the processing of polymer modified bituminous thick coatings
- for cable duct connection
- pre-assembled according to wall thickness

CONNECTION WALL SLEEVE FOR INSTALLATION IN DOUBLE WALLS/ELEMENT WALLS

Features and technical data:

- waterproof concrete stress class 1, stress class 2
- DIN 18533 W1.1-E, W1.2-E, W2.1-E
- blind seal ready for installation, watertight straight after concreting
- with integrated sealing flange for the processing of polymer modified bituminous thick coatings
- for cable duct connection
- pre-assembled according to wall thickness
- including two additional 3-ribbed seals for installation in double walls/element walls

Wall sleeve for cable duct connection



The AFR allows direct connection of a cable duct to the wall sleeve by means of plug-in or gluing sleeve, e.g. for connecting a cistern.
For suitable press seals, please see **from page 102 onwards**.

Wall sleeves

STANDARD WALL SLEEVES

AFR – CONNECTION WALL SLEEVE							
Figure	Wall sleeve OD (mm)	Type	Wall thickness (mm)	Article code	Pieces in packing unit	Article number	GTIN
Connection wall sleeve							
	110	PVC	200	AFR100/200	1	3030300004	4052487143011
					5		4052487224352
			240	AFR100/240	1	3030300005	4052487143028
					5		4052487224369
			250	AFR100/250	1	3030300006	4052487143035
					5		4052487223874
			300	AFR100/300	1	3030300007	4052487143042
					5		4052487224376
			365	AFR100/365	1	3030300008	4052487143059
					5		4052487223430
			400	AFR100/400	1	3030300009	4052487143066
					5		4052487223881
			500	AFR100/500	1	3030300010	4052487143073
					5		4052487224383

Scope of delivery: rubber sleeve (EPDM), clamping strap, sealing flange with blind plate to be knocked out, closing cover, PVC pipe OD 110 (pre-assembled).

AFRE – CONNECTION WALL SLEEVE FOR DOUBLE WALLS/ELEMENT WALLS							
Figure	Wall sleeve OD (mm)	Type	Wall thickness (mm)	Article code	Pieces in packing unit	Article number	GTIN
Connection wall sleeve for double walls/element walls							
	110	PVC	240	AFRE 100/240	1	3030300011	4052487213653
					5		4052487224680
			250	AFRE 100/250	1	3030300012	4052487139618
					5		4052487224390
			300	AFRE 100/300	1	3030300013	4052487139625
					5		4052487224406
			365	AFRE 100/365	1	3030300014	4052487139632
					5		4052487224413
			400	AFRE 100/400	1	3030300015	4052487139649
					5		4052487223447
			500	AFRE 100/500	1	3030300016	4052487139656
					5		4052487224420

Scope of delivery: rubber sleeve (EPDM), clamping strap, sealing flange with blind plate to be knocked out, closing cover (PE), PVC pipe DN 110 OD 110 (pre-assembled).

Wall sleeves

CEMENT-COATED PIPE WITH SPECIAL COATING

Features and technical data:

- waterproof concrete stress class 1, stress class 2
- made of polymer, hence extremely light
- homogeneous connection with concrete due to special cement-bound coating
- suitable for subsequent installation in breaks and rectangular openings
- closed ready for installation
- break-resistant, dimensionally stable
- easy to adapt to required wall thickness on site
- certified based on KIWA construction test
- wall sleeve ID of 50 – 300 mm
- available in all wall thicknesses
- suitable for all wall types
- maximum delivery length 3000 mm



special cement-bound coating



ZVR200/300 fixed in formwork



ZVR150 and ZVR200 set in concrete next to HSI150

Wall sleeves

STANDARD WALL SLEEVES

ZVR – STANDARD WALL SLEEVE				
Figure	Wall sleeve ID (mm)	Wall sleeve OD (mm)	Article code	Article number
	50	56	ZVR50/X	1200050XXX*
	80	95	ZVR80/X	1200080XXX*
	100	115	ZVR100/X	1200100XXX*
	125	142	ZVR125/X	1200125XXX*
	150	167	ZVR150/X	1200150XXX*
	200	219	ZVR200/X	1200200XXX*
	250	269	ZVR250/X	1200250XXX*
	300	321	ZVR300/X	1200300XXX*

X = wall thickness (mm)

* The article numbers and GTINs for the exact wall thicknesses can be found at: www.hauff-technik.com

Standard lengths: 200, 240, 250, 300, 365, 400, 500 mm

Further wall sleeve ODs on request.

From a length of > 600 mm the cement-coated pipe has a 250 mm coating on each side.



Matching press seals can be found from page 96 onwards.



STANDARD WALL SLEEVES

FIBRE CEMENT WALL SLEEVE

Features and technical data:

- waterproof concrete stress class 1, stress class 2
- asbestos free
- corrosion proof
- non-flammable
- not electrically conductive
- optimum connection with the concrete
- wall sleeve ID of 80 – 1000 mm
- peripheral outer grooves for a sealed, frictional connection to the building
- available for wall thicknesses up to 1,200 mm
- suitable for all wall types



lengthwise watertight outer grooves



FZR400/300 – installation in water treatment plant



FZR100/240 – pipe section sealing

Wall sleeves

STANDARD WALL SLEEVES

FZR – STANDARD WALL SLEEVE				
Figure	Wall sleeve ID (mm)	Wall sleeve OD (mm)	Article code	Article number
	80	≤ 140	FZR80/X	1800080XXX*
	100	≤ 160	FZR100/X	1800100XXX*
	125	≤ 165	FZR125/X	1800125XXX*
	150	≤ 190	FZR150/X	1800150XXX*
	200	≤ 245	FZR200/X	1800200XXX*
	250	≤ 293	FZR250/X	1800250XXX*
	300	≤ 350	FZR300/X	1800300XXX*
	350	≤ 400	FZR350/X	1800350XXX*
	400	≤ 470	FZR400/X	1800400XXX*
	450	≤ 520	FZR450/X	1800450XXX*
	500	≤ 570	FZR500/X	1800500XXX*
	600	≤ 680	FZR600/X	1800600XXX*
	700	≤ 800	FZR700/X	1800700XXX*
	800	≤ 910	FZR800/X	1800800XXX*
900	≤ 1.020	FZR900/X	1800900XXX*	
1.000	≤ 1.130	FZR1000/X	1801000XXX*	

X = wall thickness (mm)

* The article numbers and GTINs for the exact wall thicknesses can be found at: www.hauff-technik.com
Standard lengths: 200, 240, 250, 300, 365, 400, 500 mm



Matching press seals can be found from page 96 onwards.



ACCESSORIES FOR FZR

Figure	Wall sleeve ID (mm)	Article code	Article number	GTIN
Formwork auxiliary for fibre cement wall sleeve 2 pieces				
	80	FZR SH 80 VE2	1803000080	4052487050081
	100	FZR SH 100 VE2	1803000100	4052487050098
	125	FZR SH 125 VE2	1803000125	4052487050104
	150	FZR SH 150 VE2	1803000150	4052487050111
	200	FZR SH 200 VE2	1803000200	4052487050128
	250	FZR SH 250 VE2	1803000250	4052487188234
	300	FZR SH 300 VE2	1803000300	4052487188241
	350	FZR SH 350 VE2	1803000350	4052487188258
400	FZR SH 400 VE2	1803000400	4052487188265	

STANDARD WALL SLEEVES

FIBRE CEMENT WALL SLEEVE, SPLIT

Features and technical data:

- waterproof concrete stress class 1, stress class 2
- split design, suitable for subsequent sealing of carrier pipes/cables to building
- asbestos free
- corrosion proof
- non-flammable
- not electrically conductive
- wall sleeve ID of 80 – 800 mm
- peripheral outer grooves for a sealed, frictional connection to the building
- available for wall thicknesses up to 1,200 mm



FZRG350/300 with levelling compound from installation set MSET FZRG



FZRG350/300 – installation



FZRG150/350 – refurbishment in masonry

Wall sleeves

STANDARD WALL SLEEVES

FZRG – STANDARD WALL SLEEVE				
Figure	Wall sleeve ID (mm)	Wall sleeve OD (mm)	Article code	Article number
	80	≤ 120	FZRG80/X	1802080XXX*
	100	≤ 140	FZRG100/X	1802100XXX*
	125	≤ 165	FZRG125/X	1802125XXX*
	150	≤ 190	FZRG150/X	1802150XXX*
	200	≤ 250	FZRG200/X	1802200XXX*
	250	≤ 300	FZRG250/X	1802250XXX*
	300	≤ 350	FZRG300/X	1802300XXX*
	350	≤ 400	FZRG350/X	1802350XXX*
	400	≤ 460	FZRG400/X	1802400XXX*
	450	≤ 510	FZRG450/X	1802450XXX*
	500	≤ 570	FZRG500/X	1802500XXX*
	600	≤ 670	FZRG600/X	1802600XXX*
	700	≤ 780	FZRG700/X	1802700XXX*
	800	≤ 880	FZRG800/X	1802800XXX*
	900	≤ 980	FZRG900/X	1802900XXX*

Wall sleeves

* The article numbers and GTINs for the exact wall thicknesses can be found at: www.hauff-technik.com X = wall thickness (mm)
 Standard lengths: 200, 240, 250, 300, 365, 400, 500 mm



Matching press seals can be found from page 96 onwards.



REQUIRED ACCESSORY FOR FZRG

Item	Article code	Article number	GTIN
------	--------------	----------------	------

Installation set for FZRG
 Content: 1kg levelling compound on epoxy resin basis, spacer and latex gloves, amount of levelling compound required: approx. 65 g per 100 mm of cross-section space

	MSET FZRG	1803000000	4052487050074
---	------------------	------------	---------------

STANDARD WALL SLEEVES

RENOVATION WALL SLEEVE

Features and technical data:

- DIN 18533 W2.1-E, W2.2-E
- for retrofit installation in wall penetrations or openings, core drills hole or rectangular openings
- break-resistant, inherently stable
- can easily be shortened to required length
- suitable for all wall types except waterproof concrete
- roughened surface will homogeneously connect to mortar
- compact design accommodates smallest possible drill holes/openings
- dimensions:
SFR100: ID = 100 mm, OD = 110 mm
SFR150: ID = 150 mm, OD = 162 mm
SFR200: ID = 200 mm, OD = 214 mm

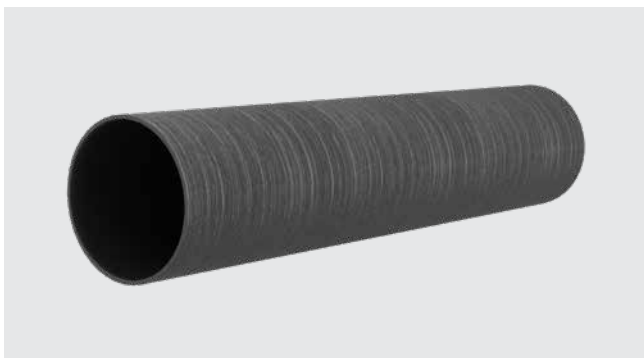

roughened surface

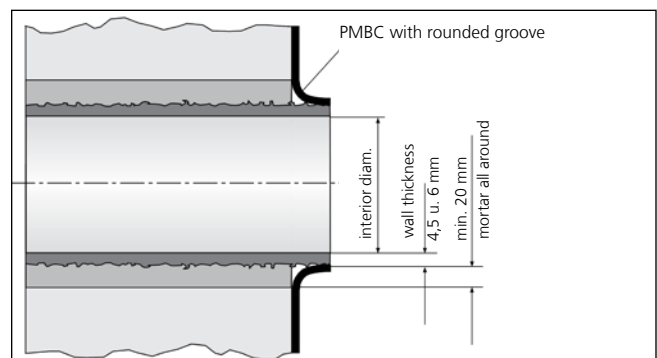

SFR – for chamfer connection with PMBC thick coating – installation according to DIN 18533

Wall sleeves

STANDARD WALL SLEEVES

SFR – RENOVATION WALL SLEEVE							
Figure	Wall sleeve ID (mm)	Wall sleeve OD (mm)	Min. drill hole diameter ID (mm)	Length (mm)	Article code	Article number	GTIN
	100	110	150	300	SFR100/300	930000050	4052487025263
	100	110	150	500	SFR100/500	930000080	4052487025294
	100	110	150	1000	SFR100/1000	930000110	4052487025324
	150	162	200	300	SFR150/300	930000140	4052487025362
	150	162	200	500	SFR150/500	930000160	4052487025386
	150	162	200	1000	SFR150/1000	930000180	4052487025409
	200	214	250	300	SFR200/300	930000220	4052487025447
	200	214	250	500	SFR200/500	930000240	4052487025461
	200	214	250	1000	SFR200/1000	930000260	4052487025485

Wall sleeves

For maximum cable configuration please refer to table **from page 92 onwards**.

Other wall thicknesses on request.



Matching press seals can be found **from page 96 onwards**.



FLANGE WALL SLEEVES

STAINLESS STEEL FLANGE

Features and technical data:

- waterproof concrete stress class 1, stress class 2
- DIN 18533 W1.1-E, DIN 18533 W1.2-E, DIN 18533 W2.1-E
- tailor-made designs can also be produced
- also available with multiple entries and in a variety of diameters
- pressure-tight sealing for core drill holes
- suitable for non-pressing and pressing water
- stainless steel A2 (AISI 304L) or A4 (AISI 316L)
- delivery inclusive rubber seal and fasteners
- for retrofit installation

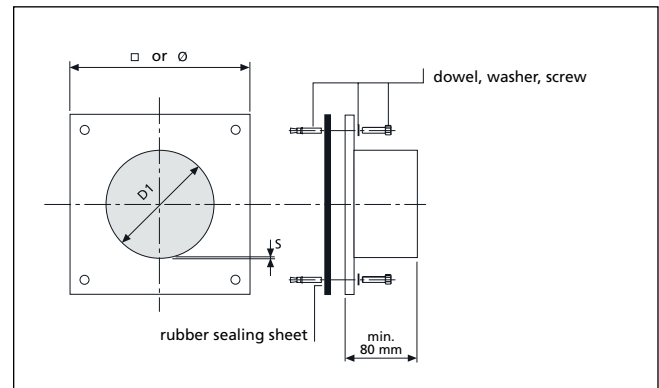
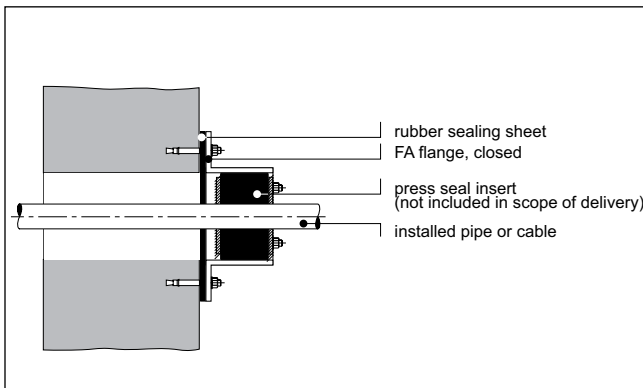

Wall sleeves

FLANGE WALL SLEEVES

FA					
Figure	Wall sleeve ID (mm)	Wall sleeve wall thickness S (mm)	Flange standard dimensions or OD (mm)	Article code	Article number
	80	2	□170	FA1x80/80 A2	910820000
	100	2	□185	FA1x100/80 A2	910830000
	125	2	□205	FA1x125/80 A2	910840000
	150	2	□225	FA1x150/80 A2	910850000
	200	3	Ø 350	FA1x200/80 A2	910870000
	250	2,5	Ø 400	FA1x250/80 A2	910880000
	300	3	Ø 450	FA1x300/80 A2	910890000
	350	3	Ø 500	FA1x350/80 A2	910893500
	400	3	Ø 550	FA1x400/80 A2	910900000
	450	4	Ø 600	FA1x450/80 A2	910900002
	500	4	Ø 650	FA1x500/80 A2	910900003

Wall sleeves

Customized dimensions available on request.
Fixing elements are included in scope of delivery!



Matching press seals can be found from page 96 onwards.



ACCESSORIES			
Figure	Article code	Article number	GTIN
290 ml cartridge, colour grey, elastic sealant to optimize wall surface in combination with sealing flanges			
	EGO SMP805	5020050084	4052487238533

FLANGE WALL SLEEVES

STAINLESS STEEL FLANGE SPLIT

Features and technical data:

- waterproof concrete stress class 1, stress class 2
- DIN 18533 W1.1-E, DIN 18533 W1.2-E, DIN 18533 W2.1-E
- pressure-tight sealing for core drill holes
- suitable for non-pressing and pressing water
- stainless steel A2 (AISI 304L) or A4 (AISI 316L)
- delivery inclusive rubber seal and fasteners
- for retrofit installation
- split design for carrier lines that have already been laid
- tailor-made designs can also be produced
- also available with multiple entries and in a variety of diameters



existing rectangular recess – has to be subsequently sealed



split rectangular flange with multiple cables

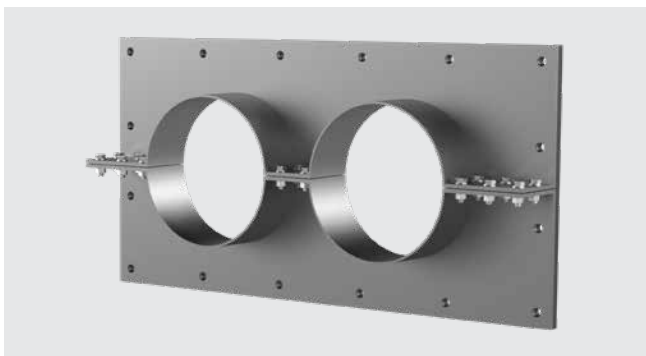

multiple flange, split
FAG 2xd

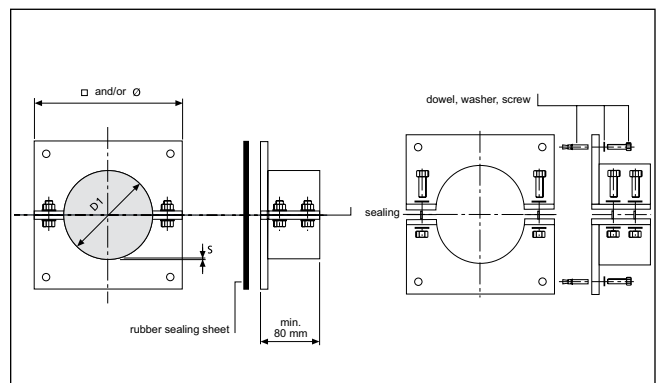
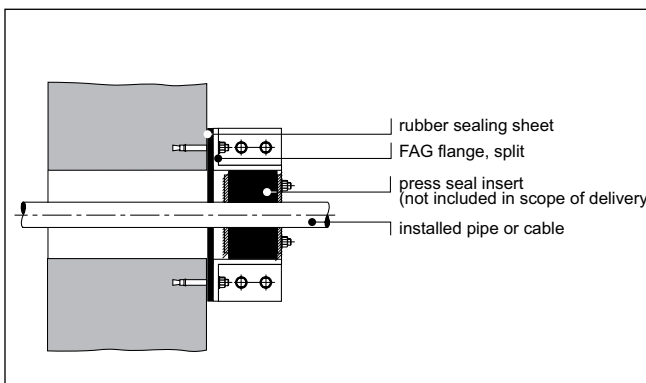

Wall sleeves

FLANGE WALL SLEEVES

FAG					
Figure	Wall sleeve ID (mm)	Wall sleeve wall thickness S (mm)	Flange standard dimensions or OD (mm)	Article code	Article number
	80	1,5	□170	FAG1x80/80 A2	910910000
	100	2	□185	FAG1x100/80 A2	910920000
	125	2	□205	FAG1x125/80 A2	910930000
	150	2	□225	FAG1x150/80 A2	910950000
	200	2	Ø 350	FAG1x200/80 A2	910960000
	250	2	Ø 400	FAG1x250/80 A2	910970000
	300	3	Ø 450	FAG1x300/80 A2	910980000
	350	3	Ø 500	FAG1x350/80 A2	910983500
	400	3	Ø 550	FAG1x400/80 A2	910990000
	450	4	Ø 600	FAG1x450/80A2	910990002
500	4	Ø 650	FAG1x500/80 A2	910990003	

Wall sleeves

Customised dimensions available on request.
Fixing elements are included in scope of delivery!



Matching press seals can be found from page 96 onwards.



ACCESSORIES			
Figure	Article code	Article number	GTIN
290 ml cartridge, colour grey, elastic sealant to optimize wall surface in combination with sealing flanges			
	EGO SMP805	5020050084	4052487238533

FLANGE WALL SLEEVES

FIXED/LOOSE FLANGE WALL SLEEVE, GALVANISED FOR SETTING IN CONCRETE IN BLACK TANK

Features and technical data:

- DIN 18533 W2.1-E, W2.2-E
- fixed/loose flange according to DIN 18533
- break-resistant
- flexible wall thickness adjustment due to wall sleeve made of polymer
- installation flush with formwork
- fixed/loose flange, galvanised steel (A3C), also available in stainless steel A2 (AISI 304L) or A4 (AISI 316L)
- for wall thicknesses 200 up to 500 mm
- recommended sealing uses for galvanised design: standard press seal HSDC (powder-coated)

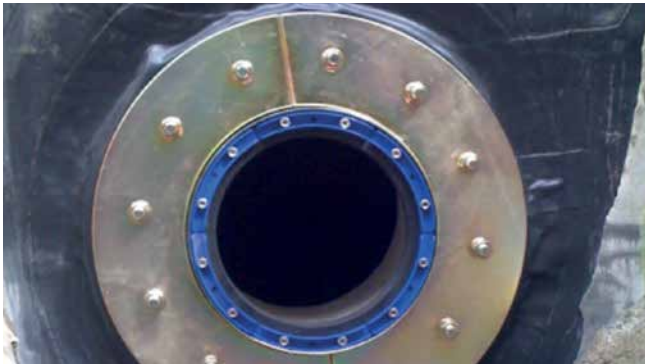

FLFE 1x200/X A3C with the standard press seal HSDC (powder-coated)



FLFE 1x200/X stainless steel design with connection to PMBC by means of fleece inlay



accessory HSDC s. **from page 118 onwards.**



accessory HRK SSG s. **from page 86 onwards.**

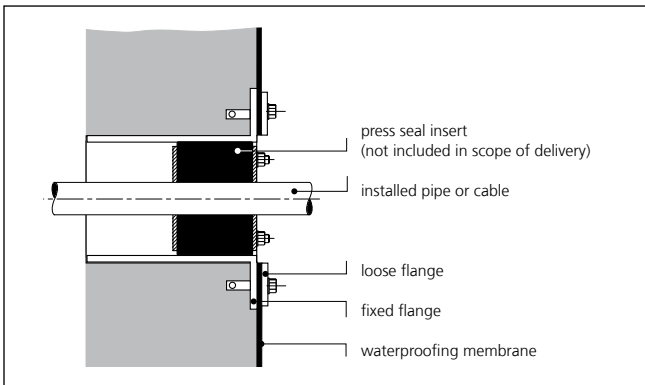

cross section – installation

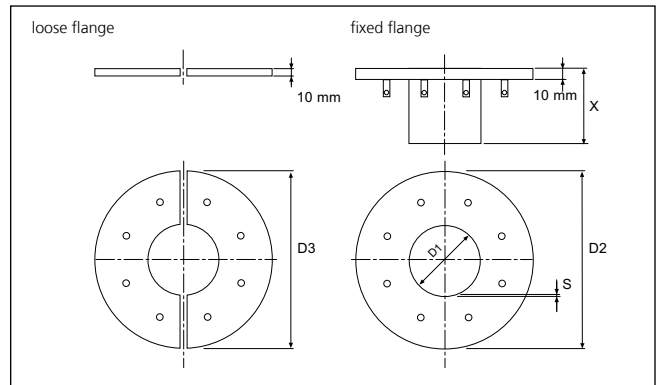



dimensions

Wall sleeves

FLANGE WALL SLEEVES

FIXED/LOOSE FLANGE WALL SLEEVE (FOR SETTING IN CONCRETE)					
Figure	Wall sleeve ID D1 (mm)	Fixed flange OD D2 (mm)	Loose flange OD D3 (mm)	Article code	Article number
	100	425	415	FLFE1x100/0/200 DIN18533 A3C	2500420100
				FLFE1x100/0/240 DIN18533 A3C	2500420103
				FLFE1x100/0/250 DIN18533 A3C	2500420106
				FLFE1x100/0/300 DIN18533 A3C	2500420109
				FLFE1x100/0/365 DIN18533 A3C	2500420112
				FLFE1x100/0/400 DIN18533 A3C	2500420115
				FLFE1x100/0/500 DIN18533 A3C	2500420118
	150	475	465	FLFE1x150/0/200 DIN18533 A3C	3030453614
				FLFE1x150/0/240 DIN18533 A3C	3030453921
				FLFE1x150/0/250 DIN18533 A3C	3030453923
				FLFE1x150/0/300 DIN18533 A3C	3030453924
				FLFE1x150/0/365 DIN18533 A3C	3030453925
				FLFE1x150/0/400 DIN18533 A3C	3030453927
				FLFE1x150/0/500 DIN18533 A3C	3030453930
	200	530	520	FLFE1x200/0/200 DIN18533 A3C	3030353471
				FLFE1x200/0/240 DIN18533 A3C	3030353474
				FLFE1x200/0/250 DIN18533 A3C	3030353475
				FLFE1x200/0/300 DIN18533 A3C	3030353476
				FLFE1x200/0/365 DIN18533 A3C	3030353477
				FLFE1x200/0/400 DIN18533 A3C	3030353478
				FLFE1x200/0/500 DIN18533 A3C	3030353479

Additional sizes on request.

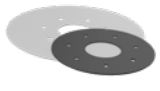
ACCESSORIES FOR FIXED/LOOSE FLANGE			
Figure	Wall sleeve ID (mm)	Article code	Article number
Supplement: EPDM (2 mm) Scope of delivery: 2 pieces			
	100	Z1x100 FLF(E/A) 18533 SET b2 EPDM55	910909051
	150	Z1x150 FLF(E/A) 18533 SET b2 EPDM55	910909053
	200	Z1x200 FLF(E/A) 18533 SET b2 EPDM55	910909054
Supplement: EPDM (6 mm) Scope of delivery: 2 pieces			
	100	Z1x100 FLF(E/A) 18533 SET b6 EPDM55	910909062
	150	Z1x150 FLF(E/A) 18533 SET b6 EPDM55	910909064
	200	Z1x200 FLF(E/A) 18533 SET b6 EPDM55	910909065
Supplement: Silicone (3 mm) Scope of delivery: 2 pieces			
	100	Z1x100 FLF(E/A) 18533 SET b3 Silikon	2500430052
	150	Z1x150 FLF(E/A) 18533 Set b3 Silikon	2500430056
	200	Z1x200 FLF(E/A) 18533 SET b3 Silikon	2500430058
Inlay set PMBC Scope of delivery: 1 fleece + 1 EPDM inlay 2 mm + silicone protective caps			
	100	Z1x100 FLF(E/A) 18533 SET PMBC	910909073
	150	Z1x150 FLF(E/A) 18533 SET PMBC	910909075
	200	Z1x200 FLF(E/A) 18533 SET PMBC	910909076

Inlays must be selected to match the building sealant.

FLANGE WALL SLEEVES

FIXED/LOOSE FLANGE WALL SLEEVE, GALVANISED FOR SUBSEQUENT SETTING ATTACHMENT IN BLACK TANK

Features and technical data:

- DIN 18533 W2.1-E, W2.2-E
- for subsequent attachment
- fixed/loose flange according to DIN 18533
- fixed/loose flange, galvanised steel (A3C), also available in stainless steel A2 (AISI 304L) and A4 (AISI 316L)
- recommended sealing uses for galvanised design: standard press seal HSDC (powder-coated)
- standard upper length 80 mm



FLFA 1x400/X A3C drainage connection



accessory HSDC s. **from page 118 onwards.**



accessory HRK SSG s. **from page 86 onwards.**

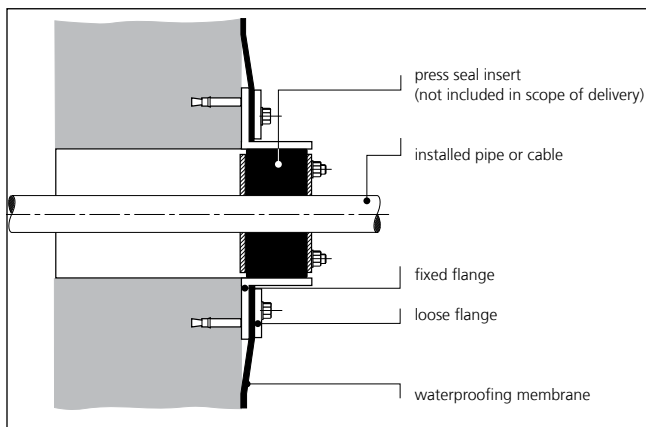

cross section – installation

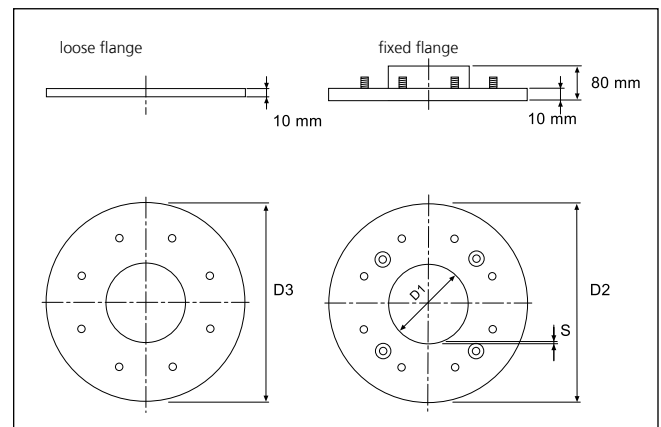



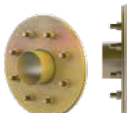

dimensions

Wall sleeves

FLANGE WALL SLEEVES

FIXED/LOOSE FLANGE WALL SLEEVE (FOR DOWELLING)					
Figure	Wall sleeve ID D1 (mm)	Fixed flange OD D2 (mm)	Loose flange OD D3 (mm)	Article code	Article number
	100	425	415	FLFA 1x100/80/0 DIN18533 A3C	3030353411
	150	475	465	FLFA 1x150/80/0 DIN18533 A3C	3030353438
	200	530	520	FLFA 1x200/80/0 DIN18533 A3C	3030353448
	250*	580	570	FLFA 1x250/80/0 DIN18533 A3C	3030353454
	300*	630	620	FLFA 1x300/80/0 DIN18533 A3C	2500410300

*The loose flange is supplied in split design. Additional sizes on request.

ACCESSORIES FOR FIXED/LOOSE FLANGE			
Figure	Wall sleeve ID (mm)	Article code	Article number
Supplement: EPDM (2 mm) Scope of delivery: 2 pieces			
	100	Z1x100 FLF(E/A) 18533 SET b2 EPDM55	910909051
	150	Z1x150 FLF(E/A) 18533 SET b2 EPDM55	910909053
	200	Z1x200 FLF(E/A) 18533 SET b2 EPDM55	910909054
	250	Z1x250 FLF(E/A) 18533 SET b2 EPDM55	910909055
	300	Z1x300 FLF(E/A) 18533 SET b2 EPDM55	910909056
Supplement: EPDM (6 mm) Scope of delivery: 2 pieces			
	100	Z1x100 FLF(E/A) 18533 SET b6 EPDM55	910909062
	150	Z1x150 FLF(E/A) 18533 SET b6 EPDM55	910909064
	200	Z1x200 FLF(E/A) 18533 SET b6 EPDM55	910909065
	250	Z1x250 FLF(E/A) 18533 SET b6 EPDM55	910909066
	300	Z1x300 FLF(E/A) 18533 SET b6 EPDM55	910909067
Supplement: Silicone (3 mm) Scope of delivery: 2 pieces			
	100	Z1x100 FLF(E/A) 18533 SET b3 Silikon	2500430052
	150	Z1x150 FLF(E/A) 18533 SET b3 Silikon	2500430056
	200	Z1x200 FLF(E/A) 18533 SET b3 Silikon	2500430058
	250	Z1x250 FLF(E/A) 18533 SET b3 Silikon	2500430060
	300	Z1x300 FLF(E/A) 18533 SET b3 Silikon	2500430062
Inlay set PMBC Scope of delivery: 1 fleece + 1 EPDM inlay 2 mm + silicone protective caps			
	100	Z1x100 FLF(E/A) 18533 SET PMBC	910909073
	150	Z1x150 FLF(E/A) 18533 SET PMBC	910909075
	200	Z1x200 FLF(E/A) 18533 SET PMBC	910909076
	250	Z1x250 FLF(E/A) 18533 SET PMBC	910909077
	300	Z1x300 FLF(E/A) 18533 SET PMBC	910909078

Inlays must be selected to match the building sealant.

Customised solutions

FLANGE WALL SLEEVES/PRESS SEALS

BEFORE



existing rectangular recess – has to be subsequently sealed

AFTER



rectangular split flange for several cable penetrations



slanted core drill in porous wall



fixed/loose flange with slanted empty hose connection and surface sealing



high-voltage cables and ducts have to be subsequently sealed in the shaft wall



split fixed/loose flange according to DIN 18533

Customised solutions

FLANGE WALL SLEEVES/PRESS SEALS



multiple flange, split
FAG 2xd

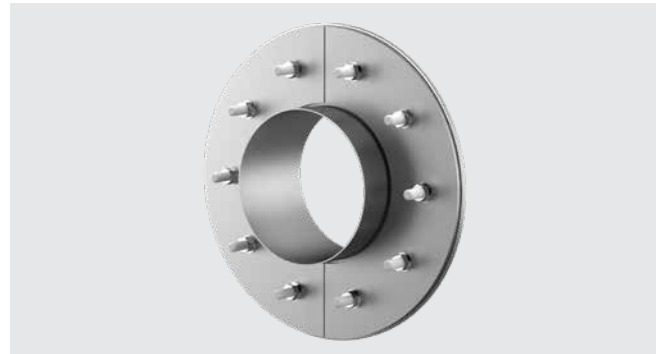

fixed/loose flange FLFA (D) for sealing according to DIN 18533 part 6



split individual press seal HRD SGi with
segmented ring technology



individual press seal HRD 150/160 SGi b60
with segmented ring technology

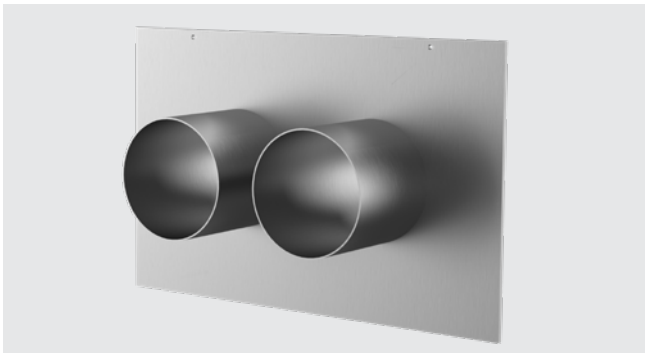

multiple wall sleeve with central flange
FUM



two-level fixed/loose flange 2FLFA for sealing according to DIN 18531

STANDARD PRESS SEAL WITH SUPER SEGMENTED RING TECHNOLOGY AND POLYMER PRESS PLATE

Features and technical data:

- gas-tight and watertight up to 2.5 bar
- sealing width 40 mm
- split seal for retrofit installation
- super segmented ring technology – individual adjustment to the installed cable diameters on site
- segments with exact diameter marking
- form-fitting connections of the press plates
- EPDM rubber
- screws and nuts made of stainless steel A4 (AISI 316L)
- polymer pressure plates made of glass fibre reinforced polyamide
- highly robust polymer press plate with reinforcement ribs





press plate with form-fitting connection



segments with exact diameter marking

Press seals for cables

STANDARD PRESS SEALS

HRK SSG – STANDARD PRESS SEAL WITH SUPER SEGMENTED RING TECHNOLOGY						
Figure	Number of cables	Cable diameter OD (mm)	Article code	Piece	Article number	GTIN
Core drill hole/wall sleeve ID 100mm						
	1	18 – 65	HRK100 SSG 1x18-65 b40 PAGF/A4/EPDM55	1	3030300044	4052487129268
	4	8 – 30	HRK100 SSG 4x8-30 b40 PAGF/A4/EPDM55	1	3030300045	4052487129251
Core drill hole/wall sleeve ID 150mm						
	1	36 – 70	HRK150 SSG 1x36-70 b40 PAGF/A4/EPDM55*	1	3030300046	4052487223614
	1	70 – 112	HRK150 SSG 1x70-112 b40 PAGF/A4/EPDM55*	1	3030300047	4052487129305
	3	24 – 54	HRK150 SSG 3x24-54 b40 PAGF/A4/EPDM55	1	1600101630	4052487129275
	6	10 – 36	HRK150 SSG 6x10-36 b40 PAGF/A4/EPDM55	1	3030300048	4052487126373
Core drill hole/wall sleeve ID 200mm						
	1	110 – 162	HRK200 SSG 1x110-162 b40 PAGF/A4/EPDM55*	1	3030300049	4052487223652
	3	40 – 72	HRK200 SSG 3x40-72 b40 PAGF/A4/EPDM55	1	3030300050	4052487134576

* Without blind plugs

ACCESSORIES			
Figure	Article code	Article number	GTIN
Core drill hole sealant for coating drill hole walls			
	KBV 2K	354040001	4052487168533

STANDARD PRESS SEAL WITH SEGMENTED RING TECHNOLOGY

Features and technical data

- gas-tight and watertight up to 2.5 bar
- sealing width 40 mm
- split seal for retrofit installation
- segmented ring technology – individually adjustable to installed cable diameters on site
- EPDM rubber
- press plate made of stainless steel A2 (AISI 304L)
- stable 5 mm press plates



HRD150 SG installed in fibre cement wall sleeves



HRD150 SG 6x8-36 5 – individually adjustable to diameters of cables



e.g. HRD150 SG 3x6-54+4x6-26 b40 A2/EPDM

Press seals for cables

STANDARD PRESS SEALS

HRD SG – STANDARD PRESS SEAL WITH SEGMENTED RING TECHNOLOGY					
Total Number of cables	Number of cables	Cable diameter OD (mm)	Article code	Article number	GTIN
Core drill hole/wall sleeve ID (mm) 80					
1	1	6 – 41	HRD80 SG 1x6-41 b40 A2/EPDM55	2700100108	4052487000109
Core drill hole/wall sleeve ID (mm) 100					
1	1	24 – 52	HRD100 SG 1x24-52 b40 A2/EPDM55	2700101000	4052487168038
4	4	8 – 30	HRD100 SG 4x8-30 b40 A2/EPDM55	2700102000	4052487000130
8	8	4 – 16,5	HRD100 SG 8x4-16,5 b40 A2/EPDM55	2700103000	4052487000147
5	2	8 – 30	HRD100 SG 2x8-30 3x4-16,5 b40 A2/EPDM55	2700103500	4052487000154
	3	4 – 16,5			
Core drill hole/wall sleeve ID (mm) 104					
1	1	24 – 52	HRD104 SG 1x24-52 b40 A2/EPDM55	2700103615	4052487129695
4	4	8 – 30	HRD104 SG 4x8-30 b40 A2/EPDM55	2700103610	4052487127370
8	8	4 – 16,5	HRD104 SG 8x4-16,5 b40 A2/EPDM55	2700103620	4052487129213
Core drill hole/wall sleeve ID (mm) 125					
3	3	10 – 40	HRD125 SG 3x10-40 b40 A2/EPDM55	2700103750	4052487063913
6	6	6 – 31	HRD125 SG 6x6-31 b40 A2/EPDM55	2700103800	4052487000161
10	10	4 – 16,5	HRD125 SG 10x4-16,5 b40 A2/EPDM55	2700103850	4052487000178
Core drill hole/wall sleeve ID (mm) 150					
1	1	12 – 75	HRD150 SG 1x12-75 b40 A2/EPDM55	2700103996	4052487063951
1	1	75 – 110	HRD150 SG 1x75-110 b40 A2/EPDM55	2700103998	4052487063968
3	3	22 – 54	HRD150 SG 3x22-54 b40 A2/EPDM55	2700104000	4052487000185
6	6	8 – 35	HRD150 SG 6x8-35 b40 A2/EPDM55	2700105000	4052487000192
9	9	6 – 25	HRD150 SG 9x6-25 b40 A2/EPDM55	2700106000	4052487000208
10	4	8 – 30	HRD150 SG 4x8-30+6x4-16,5 b40 A2/EPDM55	2700106500	4052487000215
	6	4 – 16,5			
Core drill hole/wall sleeve ID (mm) 200					
7	3	6 – 54	HRD200 SG 3x6-54+4x6-26 b40 A2/EPDM55	2700107000	4052487000222
	4	6 – 26			
15	7	10 – 32	HRD200 SG 7x10-32+8x3,5-16,5 b40 A2/EPDM	2700108000	4052487000239
	8	3,5 – 16,5			

Press seals

INDIVIDUAL PRESS SEALS



INDIVIDUAL PRESS SEAL WITH INTEGRATED TEST VALVE

Features and technical data:

- gas-tight and watertight up to 2.5 bar
- seal width 2 x 30 mm
- closed or split
- different outer diameters can be manufactured exactly to customers' requirements
- easy to install
- optionally available with overlapping flange (F) or eccentric
- simple monitoring/control tests possible
- with integrated test valve
- short delivery times
- for core drills/wall sleeve diameter 80 – 300 mm
- EPDM, NBR, KTW or silicone rubber
- suitable for sealing rigid cable ducts
- press plate made from stainless steel A2 (AISI 304L), optionally A4 (AISI 316L)
- stable 5 mm press plate



HRD150 PV G in core drill

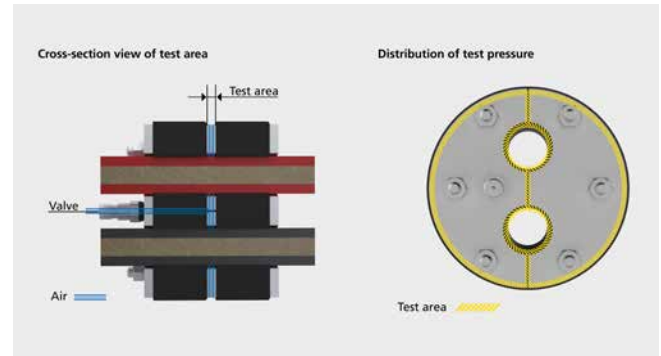

HRD150 PV G in core drill

CONFIGURATION TABLE							
z = number of cables/ pipes	Core drill diameter HRD80 (mm)	Core drill diameter HRD100 (mm)	Core drill diameter HRD125 (mm)	Core drill diameter HRD150 (mm)	Core drill diameter HRD200 (mm)	Core drill diameter HRD250 (mm)	Core drill diameter HRD300 (mm)
	Cable/pipe diameter = d_{max} (mm)						
1	35	55	80	105	155	205	255
2	22	32	44	57	82	106	131
3	18	28	40	50	75	98	120
4	14	23	34	44	65	85	105
5	10	18	28	38	57	76	92
6	8	17	25	34	50	66	83
7	8	15	23	32	48	62	80

d = cable diameter

Press seals for cables

INDIVIDUAL PRESS SEALS

HRD PV – INDIVIDUAL PRESS SEAL WITH INTEGRATED TEST VALVE			
Figure	Core drill hole/wall sleeve ID (mm)	Optimum application range diameter OD for 1 cable (mm)	Closed design Article code
 <p>e.g. HRD150 PV 2x25</p>	80	0 – 30	HRD80 PV zxd b60 A2/EPDM55
	100	0 – 50	HRD100 PV zxd b60 A2/EPDM55
	125	0 – 75	HRD125 PV zxd b60 A2/EPDM55
	150	0 – 100	HRD150 PV zxd b60 A2/EPDM55
	200	0 – 150	HRD200 PV zxd b60 A2/EPDM55
	250	0 – 200	HRD250 PV zxd b60 A2/EPDM55
	300	0 – 250	HRD300 PV zxd b60 A2/EPDM55

Customized diameters available.

* For maximum cable configuration please refer to table on the left.

HRD PV G – INDIVIDUAL PRESS SEAL WITH INTEGRATED TEST VALVE, SPLIT			
Figure	Core drill hole/wall sleeve ID (mm)	Optimum application range diameter OD for 1 cable (mm)	Split design Article code
 <p>e.g. HRD150 PV G 2x25</p>	80	0 – 30	HRD80 PV G 1/d b60 A2/EPDM55
	100	0 – 50	HRD100 PV G 1/d b60 A2/EPDM55
	125	0 – 75	HRD125 PV G 1/d b60 A2/EPDM55
	150	0 – 100	HRD150 PV G 1/d b60 A2/EPDM55
	200	0 – 150	HRD200 PV G 1/d b60 A2/EPDM55
	250	0 – 200	HRD250 PV G 1/d b60 A2/EPDM55
	300	0 – 250	HRD300 PV G 1/d b60 A2/EPDM55

Customized diameters available.

* For maximum cable configuration please refer to table on the left.

Further variants: blind insert, article code: e.g. HRD117 PV 0

eccentric sealing insert, article code: e.g. HRD156 PV G 1x45 ex23

All individual press seal variants also available with overlapping flange.

ACCESSORIES			
Figure	Article code	Article number	GTIN
Test pump with digital manometer			
	DIGIT PPM HRD	1551001121	4052487168472

Press seals

INDIVIDUAL PRESS SEALS



INDIVIDUAL PRESS SEAL, SEAL WIDTH 30 MM

Features and technical data:

- gas-tight and watertight up to 2.5 bar
- sealing width 30 mm
- closed or split
- different outer diameters can be manufactured exactly to customers' requirements
- easy to mount
- optionally available with overlapping flange (F) or eccentric
- suitable for one or more cables
- for core drills/wall sleeve from diameter 25 mm
- EPDM, NBR or silicone rubber
- suitable for sealing rigid cable ducts
- press plate made from stainless steel A2 (AISI 304L), optionally A4 (AISI 316L)
- stable 5 mm press plate



HRD150 G b30 with multiple entry



HRD200 G b30 installed in a steel pipe

CONFIGURATION TABLE							
z = number of cables/ pipes	Core drill diameter HRD 50 (mm)	Core drill diameter HRD 80 (mm)	Core drill diameter HRD 100 (mm)	Core drill diameter HRD 125 (mm)	Core drill diameter HRD 150 (mm)	Core drill diameter HRD 200 (mm)	Core drill diameter HRD 250 (mm)
	Cable/pipe diameter = d_{max} (mm)						
1	26	56	76	101	125	171	214
2	16	31	41	53	66	91	116
3	14	28	37	49	60	84	107
4	12	24	32	43	53	74	95
5	8	21	28	38	47	65	84
6	5	18	25	33	42	58	75
7	-	15	21	32	39	56	73

Further sizes up to diameter 1,500 mm available at short notice on request.

d = cable diameter

Press seals for cables

INDIVIDUAL PRESS SEALS

HRD b30 – INDIVIDUAL PRESS SEAL, SEAL WIDTH 30 MM, CLOSED

Figure	Core drill hole/wall sleeve ID (mm)	Closed design Article code
	50	HRD50 zxd b30 A2/EPDM55
	60	HRD60 zxd b30 A2/EPDM55
	70	HRD70 zxd b30 A2/EPDM55
	80	HRD80 zxd b30 A2/EPDM55
	100	HRD100 zxd b30 A2/EPDM55
	125	HRD125 zxd b30 A2/EPDM55
	150	HRD150 zxd b30 A2/EPDM55
	200	HRD200 zxd b30 A2/EPDM55
	250	HRD250 zxd b30 A2/EPDM55

Customized diameters available.

* For maximum cable configuration please refer to table on the left.

HRD G b30 – INDIVIDUAL PRESS SEAL, SEAL WIDTH 30 MM, SPLIT

Figure	Core drill hole/wall sleeve ID (mm)	Split design Article code
	50	HRD50 G zxd b30 A2/EPDM55
	60	HRD60 G zxd b30 A2/EPDM55
	70	HRD70 G zxd b30 A2/EPDM55
	80	HRD80 G zxd b30 A2/EPDM55
	100	HRD100 G zxd b30 A2/EPDM55
	125	HRD125 G zxd b30 A2/EPDM55
	150	HRD150 G zxd b30 A2/EPDM55
	200	HRD200 G zxd b30 A2/EPDM55
	250	HRD250 G zxd b30 A2/EPDM55

Customized diameters available.

* For maximum cable configuration please refer to table on the left.

Further variants: blind insert, article code: e.g. HRD117 0 b30,
eccentric sealing insert, article code: e.g. HRD156 G1x45 ex23
All individual press seal variants also available with overlapping flange.

INDIVIDUAL PRESS SEALS



INDIVIDUAL PRESS SEAL, SEAL WIDTH 60 MM

Features and technical data:

- gas-tight and watertight up to 5 bar
- sealing width 60 mm
- closed or split
- different outer diameters can be manufactured exactly to customers' requirements
- easy to install
- optionally available with overlapping flange (F) or eccentric
- suitable for one or more cables
- for core drills/wall sleeves from diameter 25 mm
- EPDM, NBR or silicone rubber
- press plate made from stainless steel A2 (AISI 304L), optionally A4 (AISI 316L)
- stable 5 mm press plate



HRD100 0 b60 blind seal



HRD150 G 2x18+2x27

CONFIGURATION TABLE

z = number of cables/ pipes	Core drill diameter HRD 50 (mm)	Core drill diameter HRD 80 (mm)	Core drill diameter HRD 100 (mm)	Core drill diameter HRD 125 (mm)	Core drill diameter HRD 150 (mm)	Core drill diameter HRD 200 (mm)	Core drill diameter HRD 250 (mm)
	Cable/pipe diameter = d_{max}						
1	26	56	76	101	125	171	214
2	16	31	41	53	66	91	116
3	14	28	37	49	60	84	107
4	12	24	32	43	53	74	95
5	8	21	28	38	47	65	84
6	5	18	25	33	42	58	75
7	-	15	21	32	39	56	73

Further sizes up to diameter 1,500 mm available at short notice on request.

d = cable diameter

Press seals for cables

INDIVIDUAL PRESS SEALS

HRD b60 – INDIVIDUAL PRESS SEAL, SEAL WIDTH 60 MM, CLOSED

Figure	Core drill hole/wall sleeve ID (mm)	Closed design Article code
	50	HRD50 zxd b60 A2/EPDM55
	60	HRD60 zxd b60 A2/EPDM55
	70	HRD70 zxd b60 A2/EPDM55
	80	HRD80 zxd b60 A2/EPDM55
	100	HRD100 zxd b60 A2/EPDM55
	125	HRD125 zxd b60 A2/EPDM55
	150	HRD150 zxd b60 A2/EPDM55
	200	HRD200 zxd b60 A2/EPDM55
	250	HRD250 zxd b60 A2/EPDM55

Customized diameters available.

* For maximum cable configuration please refer to table on the left.

Press seals

HRD G b60 – INDIVIDUAL PRESS SEAL, SEAL WIDTH 60 MM, SPLIT

Figure	Core drill hole/wall sleeve ID (mm)	Split design Article code
	50	HRD50 G zxd b60 A2/EPDM55
	60	HRD60 G zxd b60 A2/EPDM55
	70	HRD70 G zxd b60 A2/EPDM55
	80	HRD80 G zxd b60 A2/EPDM55
	100	HRD100 G zxd b60 A2/EPDM55
	125	HRD125 G zxd b60 A2/EPDM55
	150	HRD150 G zxd b60 A2/EPDM55
	200	HRD200 G zxd b60 A2/EPDM55
	250	HRD250 G zxd b60 A2/EPDM55

Customized diameters available.

* For maximum cable configuration please refer to table on the left.

Further variants: blind insert, article code: e.g. HRD117 0 b60,
 split, eccentric sealing insert, article code: e.g. HRD137 G 1x39 ex20
 All individual press seal variants also available with overlapping flange.

Press seals for pipes

STANDARD PRESS SEALS



MODULAR SEAL

Features and technical data:

- gas-tight and watertight up to 5 bar
- with integrated, visual installation control – no torque wrench required
- for retrofit installation
- no retightening required
- nuts moulded in the pressure plates – no loose parts
- optimised screw geometry
- made in Germany
- all metal parts made of high quality stainless steel A4 (AISI 316L)
- premium rubber qualities EPDM or NBR
- made of high quality fibre-glass reinforced polyamide
- watertight up to 5 bar, certified by Lloyds Register



GKD400 – installation preparation with lubricant GM



GKD400 – mounting of segments



GKD400 – tightening of segments



GKD400 – fully installed





GKD – fully installed, all viewing windows are filled with yellow.



GKD with one segment not tightened – installation error immediately detected.

Press seals for pipes

STANDARD PRESS SEALS

MODULAR SEAL GKD							
Figure	Ring gap (mm)		Carrier pipe OD (mm)		Installation depth (mm)	Article code	Article number
	from	to	from	to			
EPDM							
	12,7	16,0	21,3	323,9	75	X* GKD200 EPDM50	**
	16,0	20,0	25,0	90,0	75	X* GKD275 EPDM50	**
	19,5	22,5	73,5	250	100	X* GKD300 EPDM50	**
	23,25	26	60,3	315	100	X* GKD315 EPDM50	**
	24	30	177,8	711	110	X* GKD325 EPDM50	**
	25,5	34,0	30,0	323,9	120	X* GKD340 EPDM50	**
	32,0	42,0	40,0	406,4	120	X* GKD360 EPDM50	**
	36,5	43	204	1220	150	X* GKD400 EPDM50	**
	37,0	48,5	60,3	323,9	140	X* GKD410 EPDM50	**
	29	35	204	1220	125	X* GKD425 EPDM50	**
	45	52	204	1220	150	X* GKD440 EPDM50	**
	41,3	48,5	114,3	1220	150	X* GKD475 EPDM50	**
	62	71,5	193,7	1220	165	X* GKD500 EPDM50	**
	58	63,5	193,7	1220	165	X* GKD525 EPDM50	**
	50	58	204	1220	165	X* GKD575 EPDM50	**
	90	98	323,9	3000	205	X* GKD615 EPDM50	**
77	84	244,5	2000	165	X* GKD650 EPDM50	**	
NBR							
	12,7	16,0	21,3	323,9	75	X* GKD200 NBR50	**
	16,0	20,0	25,0	90,0	75	X* GKD275 NBR50	**
	19,5	22,5	73,5	250	100	X* GKD300 NBR50	**
	23,25	26	60,3	315	100	X* GKD315 NBR50	**
	24	30	177,8	711	110	X* GKD325 NBR50	**
	25,5	34,0	30,0	323,9	120	X* GKD340 NBR50	**
	32,0	42,0	40,0	406,4	120	X* GKD360 NBR50	**
	36,5	43	204	1220	150	X* GKD400 NBR50	**
	37,0	48,5	60,3	323,9	140	X* GKD410 NBR50	**
	29	35	204	1220	125	X* GKD425 NBR50	**
	45	52	204	1220	150	X* GKD440 NBR50	**
	41,3	48,5	114,3	1220	150	X* GKD475 NBR50	**
	62	71,5	193,7	1220	165	X* GKD500 NBR50	**
	58	63,5	193,7	1220	165	X* GKD525 NBR50	**
	50	58	204	1220	165	X* GKD575 NBR50	**
	90	98	323,9	3000	205	X* GKD615 NBR50	**
77	84	244,5	2000	165	X* GKD650 NBR50	**	

* The complete article number is derived from the number of links
 ** on demand

X = number of links

To obtain the product that suits your requirements, use the product configurator at www.hauff-technik.com

Press seals

STANDARD-PRESS SEALS

MODULAR SEAL GKD – SELECTION TABLE							
Wall opening ID (mm)	Carrier pipe OD (mm)		Number of segments	Type GKD	Minimum installation depth	Article number	GTIN
	from	to					
65	25	33	6	275	75	3030420544	4052487240079
70	30	38	7	275	75	**	**
	38	44	6	200	75	3030438186	4052487240086
80	48	54	7	200	75	3030426876	4052487240093
100	32	49	5	340	120	**	**
	58	63	6	300	100	1410030006	4052487159623
125	73	78	8	315	100	1410031508	4052487144186
	79	88	8	300	100	1410030008	4052487144070
150	53	76	5	410	140	3030412078	4052487232753
	66	86	6	360	120	3030420547	4052487240109
	82	99	9	340	120	3030421880	4052487240116
	98	103	10	315	100	1410031510	4052487142168
	104	113	10	300	100	1410030010	4052487142137
200	108	117	7	475	150	1410047507	4052487142502
	132	149	13	340	120	3030430136	4052487240123
	148	152	14	315	100	1410031514	4052487144230
	153	153	15	315	100	1410031515	4052487144247
	154	160	13	300	100	1410030013	4052487144117
	161	163	14	300	100	1410030014	4052487144124
250	153	166	9	475	150	1410047509	4052487145398
	167	167	10	475	150	1410047510	4052487145404
	169	177	7	400	150	1410040007	4052487157506
	178	189	7	425	125	1410042507	4052487190152
	190	202	9	325	110	1410032509	4052487144377
	203	203	19	315	100	1410031519	4052487144285
	204	213	17	300	100	1410030017	4052487144155
300	157	167	7	500	165	1410050007	4052487189576
	168	176	8	500	165	1410050008	4052487142564
	178	184	8	525	165	1410052508	4052487143554
	185	195	10	575	165	1410057510	4052487143561
	196	203	8	440	150	1410044008	4052487142434
	203	203	11	475	150	1410047511	4052487145411
	204	208	8	440	150	1410044008	4052487142434
	204	217	12	475	150	1410047512	4052487143189
	218	227	9	400	150	1410040009	4052487144568
	228	242	9	425	125	1410042509	4052487144834
	243	252	11	325	110	1410032511	4052487144391
253	253	23	315	100	1410031523	4052487144322	
254	263	21	300	100	1410030021	4052487189224	

** on demand

Press seals for pipes

STANDARD-PRESS SEALS

MODULAR SEAL GKD – SELECTION TABLE							
Wall opening ID (mm)	Carrier pipe OD (mm)		Number of segments	Type GKD	Minimum installation depth	Article number	GTIN
	from	to					
350	207	222	9	500	165	1410050009	4052487145855
	223	234	9	525	165	1410052509	4052487146142
	235	245	12	575	165	1410057512	4052487146470
	246	252	9	440	150	1410044009	4052487145121
	253	260	10	440	150	1410044010	4052487145138
	261	266	14	475	150	1410047514	4052487143196
	264	277	10	400	150	1410040010	4052487144575
	278	292	11	425	125	1410042511	4052487144858
	293	302	13	325	110	1410032513	4052487144414
	303	303	27	315	100	1410031527	4052487144360
	304	313	25	300	100	1410030025	4052487189262
400	257	276	11	500	165	1410050011	4052487145879
	277	284	11	525	165	1410052511	4052487146166
	285	295	14	575	165	1410057514	4052487146494
	296	310	11	440	150	1410044011	4052487145145
	311	313	16	475	150	1410047516	4052487145442
	314	329	12	400	150	1410040012	4052487143097
	330	341	12	425	125	1410042512	4052487144865
	342	342	13	425	125	1410042513	4052487144872
	343	352	15	325	110	1410032515	4052487144438
	353	353	31	315	100	1410031533	4052487189835
	354	360	28	300	100	1410030028	4052487189293
450	307	326	12	500	165	1410050012	4052487145886
	327	332	12	525	165	1410052512	4052487146180
	333	334	13	525	165	1410052513	4052487146197
	334	345	16	575	165	1410057516	4052487146517
	346	360	13	440	150	1410044013	4052487145169
	361	367	19	475	150	1410047519	4052487145473
	364	377	14	400	150	1410040014	4052487144605
	378	392	14	425	125	1410042514	4052487143141
	390	402	17	325	110	1410032517	4052487144445
	398	403	35	315	100	1410031535	4052487189859
	404	413	32	300	100	1410030032	4052487189316

Press seals

STANDARD-PRESS SEALS

MODULAR SEAL GKD – SELECTION TABLE							
Wall opening ID (mm)	Carrier pipe OD (mm)		Number of segments	Type GKD	Minimum installation depth	Article number	GTIN
	from	to					
500	332	346	13	650	165	1410065013	4052487147415
	357	376	14	500	165	1410050014	4052487145909
	374	384	14	525	165	1410052514	4052487146203
	384	384	17	575	165	1410057517	4052487146524
	385	400	18	575	165	1410057518	4052487146531
	396	410	14	440	150	1410044014	4052487145176
	403	417	21	475	150	1410047521	4052487145497
	414	427	15	400	150	1410040015	4052487144612
	428	442	16	425	125	1410042516	4052487143158
	440	452	19	325	110	1410032519	4052487144469
	448	453	39	315	100	1410031539	4052487189897
	454	463	36	300	100	1410030036	4052487189354
550	350	370	9	615	205	1410061509	4052487146852
	382	396	15	650	165	1410065015	4052487147439
	407	417	15	500	150	1410050015	4052487145916
	418	426	16	500	150	1410050016	4052487145923
	423	434	16	525	165	1410052516	4052487146227
	434	435	19	575	165	1410057519	4052487146548
	436	450	20	575	165	1410057520	4052487146555
	446	460	16	440	150	1410044016	4052487145190
	453	467	23	475	150	1410047523	4052487145510
	464	477	17	400	150	1410040017	4052487143103
	478	488	17	425	125	1410042517	4052487144896
	489	492	18	425	125	1410042518	4052487144902
490	502	21	325	110	1410032521	4052487144483	

Press seals for pipes

STANDARD-PRESS SEALS

MODULAR SEAL GKD – SELECTION TABLE							
Wall opening ID (mm)	Carrier pipe OD (mm)		Number of segments	Type GKD	Minimum installation depth	Article number	GTIN
	from	to					
600	400	420	10	615	205	1410061510	4052487146869
	432	446	16	650	165	1410065016	4052487147446
	457	476	17	500	165	1410050017	4052487145930
	473	484	17	525	165	1410052517	4052487146234
	484	486	21	575	165	1410057521	4052487146562
	487	500	22	575	165	1410057522	4052487146579
	496	510	17	440	150	1410044017	4052487145206
	503	516	25	475	150	1410047525	4052487145534
	517	517	26	475	150	1410047526	4052487145541
	514	527	19	400	150	1410040019	4052487143110
	528	542	19	425	125	1410042519	4052487144919
540	552	23	325	110	1410032523	4052487144506	
650	450	470	11	615	205	1410061511	4052487146876
	482	496	18	650	165	1410065018	4052487147460
	507	526	19	500	165	1410050019	4052487145954
	523	534	19	525	165	1410052519	4052487146258
	534	537	23	575	165	1410057523	4052487146586
	538	550	24	575	165	1410057524	4052487146593
	546	560	19	440	150	1410044019	4052487145220
	553	554	27	475	150	1410047527	4052487145558
	555	567	28	475	150	1410047528	4052487145565
	564	576	20	400	150	1410040020	4052487143127
	577	577	21	400	150	1410040021	4052487142311
	578	592	21	425	125	1410042521	4052487142380
590	602	25	325	110	1410032525	4052487144520	

Press seals

ACCESSORIES			
Figure	Article code	Article number	GTIN
Lubricant stick GM, included (up to 10 links – 1 x lubricant stick from 11 links – 2 x lubricant sticks)			
	GM	5180040008	4052487233378

STANDARD PRESS SEAL WITH GRADATED SUPER SEGMENT TECHNOLOGY

Features and technical data:

- gas-tight and watertight up to 2.5 bar
- installation according to DIN 18533 in the relevant installation parts/flanges
- pipe seal can also be used as a blind insert
- for core drills/wall sleeve, diameter 100 – 300 mm
- super segment ring technology allows individual adjustment to the cable/pipe diameter on site
- particularly suitable for stock thanks to the wide application range
- segments with exact diameter indication and predefined breaking point
- U-profile press segments made of stainless steel A2 (AISI 304L) or A4 (AISI 316L)
- visual and tangible installation reliability due to built-in inspection opening
- seal width 40 mm
- rubber quality in EPDM or NBR



super segment ring technology with exact diameter marking



U-profile press segments made of stainless steel A2 (AISI 304L) or A4 (AISI 316L)



visual and tangible installation reliability due to built-in inspection opening



blind closed



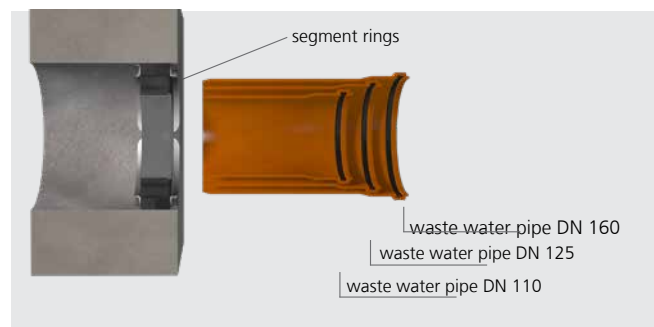

split/can be subsequently split





The universal press seal HSD200 SSG 1x110/125/135/160 b40 is suitable for sealing standard pipes with OD 110, 125 and 160 mm.

Press seals for pipes

STANDARD-PRESS SEALS

HSD SSG – STANDARD PRESS SEALS FOR ONE CARRIER PIPE						
Figure	Item, suitable for carrier pipes OD (mm)	Core drill hole/wall sleeve ID (mm)	Article code	Pieces in packing unit	Article number	GTIN
	Standard press seal, graduated 25, 32, 40, 50, 63	100	HSD100 SSG 1x25/32/40/50/63 b40 A2/...	1	3030300058	4052487121286
				15		4052487223713
	Standard press seal, graduated 75, 90, 110	150	HSD150 SSG 1x75/90/110 b40 A2/EPDM	1	3030300062	4052487121804
				15		4052487223744
	Standard press seal, graduated 110, 125, 135, 160	200	HSD200 SSG 1x110/125/135/160 b40 A2/...	1	3030300067	4052487123624
				15		4052487223782
	Standard press seal, continuous 18 – 65	100	HSD100 SSG 1x18-65 b40 A2/EPDM55	1	3030300060	4052487165655
				15		4052487223737
	Standard press seal, continuous 70 – 112	150	HSD150 SSG 1x70-112 b40 A2/EPDM55	1	3030300064	4052487129015
				15		4052487223751
	Standard press seal, continuous 110 – 162	200	HSD200 SSG 1x110-162 b40 A2/EPDM55	1	3030300068	4052487129022
				15		4052487223799
	Standard press seal, continuous 159 – 211	250*	HSD250 SSG 1x159-211 b40 A2/EPDM55	1	3030300072	4052487129374
				4		4052487223805
	Standard press seal, continuous 200 – 252	300*	HSD300 SSG 1x200-252 b50 A2/EPDM55	1	3030300076	4052487129381
				4		4052487223812

* Blind cap available as an optional accessory.
Other types in A4 (AISI 316L) and NBR on request.

OPTIONAL ACCESSORIES – BLIND CAP					
Figure	Suitable for use in press seals ID (mm)	Article code	Pieces in packing unit	Article number	GTIN
Cap for HSD250 SSG 1x159-211 b40 A4/EPDM55					
	160	HSD250 SSG D	1	5199990021	4052487233514
			4		4052487233743
Cap for HSD300 SSG 1x200-252 b50 A4/EPDM55					
	200	HSD300 SSG D	1	5199990019	4052487233538
			4		4052487233736

Press seals

Press seals for pipes

STANDARD-PRESS SEALS



STANDARD PRESS SEAL, SEAL WIDTH 40 MM

Features and technical data:

- gas-tight and watertight up to 2.5 bar
- very diverse range of material combinations for customised solutions
- available from stock
- visual and tangible installation reliability due to built-in inspection opening
- can be split for retrofit on site installation up to 200 mm diameter
- from 250 mm diameter split design
- U-profile: maximum stability of the press segments
- seal width 40 mm
- stainless steel A2 (AISI 304L) and A4 (AISI 316L)
- rubber quality in EPDM, NBR and available with KTW approval
- for core drill hole/wall sleeve up to 500 mm diameter
- pipe size 32 – 450 mm diameter



HSD200 1x160 b40 A2/EPDM55 – drainage SML pipe



HSD500 G 1x429 b40 A2/EPDM55 – ventilation and air extraction

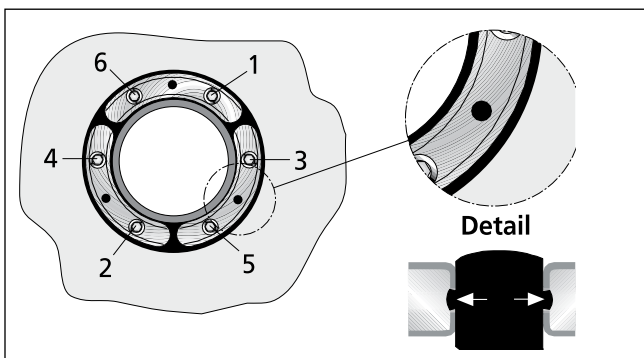

detail view – HSD
inspection opening and tightening order of screws



Press seals for pipes

STANDARD-PRESS SEALS

STANDARD PRESS SEAL HSD, A2/EPDM55, Seal width 40 mm					
Core drill hole/ wall sleeve ID (mm)	Suitable for carrier pipe OD (mm) from to		Article code	Article number	GTIN
100	32	34	HSD100 1x32 b40 A2/EPDM55	1650010032	4052487121347
	40	43	HSD100 1x40 b40 A2/EPDM55	1650010040	4052487121408
	48	51	HSD100 1x48 b40 A2/EPDM55	1650010048	4052487121460
	60	63,5	HSD100 1x60 b40 A2/EPDM55	1650010060	4052487121521
125	60	63,5	HSD125 1x60 b40 A2/EPDM55	1650012060	4052487121583
	75	77	HSD125 1x75 b40 A2/EPDM55	1650012075	4052487121644
	78	81	HSD125 1x78 b40 A2/EPDM55	1650012085	4052487121705
150	78	81	HSD150 1x78 b40 A2/EPDM55	1650015078	4052487121828
	88	92	HSD150 1x88 b40 A2/EPDM55	1650015088	4052487121880
	110	113	HSD150 1x110 b40 A2/EPDM55	1650015110	4052487121941
200	110	113	HSD200 1x110 b40 A2/EPDM55	1650020100	4052487122047
	114	119	HSD200 1x114 b40 A2/EPDM55	1650020110	4052487122108
	125	128	HSD200 1x125 b40 A2/EPDM55	1650020120	4052487122160
	133	136	HSD200 1x133 b40 A2/EPDM55	1650020130	4052487122221
	139	141	HSD200 1x139 b40 A2/EPDM55	1650020140	4052487122283
	159	163	HSD200 1x159 b40 A2/EPDM55	1650020150	4052487122344
250	159	163	HSD250 G 1x159 b40 A2/EPDM55	1650025150	4052487122443
	168	171	HSD250 G 1x168 b40 A2/EPDM55	1650025160	4052487122504
	177	181	HSD250 G 1x177 b40 A2/EPDM55	1650025170	4052487122566
	200	201	HSD250 G 1x200 b40 A2/EPDM55	1650025200	4052487122627
	210	211	HSD250 G 1x210 b40 A2/EPDM55	1650025210	4052487122689
300	198	202	HSD300 G 1x200 b40 A2/EPDM55	1650030200	4052487122788
	208	212	HSD300 G 1x210 b40 A2/EPDM55	1650030210	4052487122849
	217	221	HSD300 G 1x219 b40 A2/EPDM55	1650030220	4052487122900
	223	227	HSD300 G 1x225 b40 A2/EPDM55	1650030230	4052487122962
	248	252	HSD300 G 1x250 b40 A2/EPDM55	1650030250	4052487123020
400	273	276	HSD400 G 1x273 b40 A2/EPDM55	1650040270	4052487123082
	277	282	HSD400 G 1x277 b40 A2/EPDM55	1650040280	4052487123143
	315	321	HSD400 G 1x315 b40 A2/EPDM55	1650040310	4052487123204
	324	328	HSD400 G 1x324 b40 A2/EPDM55	1650040320	4052487123266
500	398	402	HSD500 G 1x400 b40 A2/EPDM55	1650050400	4052487123327
	427	431	HSD500 G 1x429 b40 A2/EPDM55	1650050430	4052487123389
	448	452	HSD500 G 1x450 b40 A2/EPDM55	1650050450	4052487123440

Press seals

STANDARD-PRESS SEALS

STANDARD PRESS SEAL HSD, A4/EPDM55, Seal width 40 mm					
Core drill hole/ wall sleeve ID (mm)	Suitable for carrier pipe OD (mm) from to		Article code	Article number	GTIN
100	32	34	HSD100 1x32 b40 A4/EPDM55	1650010036	4052487121378
	40	43	HSD100 1x40 b40 A4/EPDM55	1650010044	4052487121439
	48	51	HSD100 1x48 b40 A4/EPDM55	1650010052	4052487121491
	60	63,5	HSD100 1x60 b40 A4/EPDM55	1650010064	4052487121552
125	60	63,5	HSD125 1x60 b40 A4/EPDM55	1650012064	4052487121613
	75	77	HSD125 1x75 b40 A4/EPDM55	1650012079	4052487121675
	78	81	HSD125 1x78 b40 A4/EPDM55	1650012089	4052487121736
150	78	81	HSD150 1x78 b40 A4/EPDM55	1650015082	4052487121859
	88	92	HSD150 1x88 b40 A4/EPDM55	1650015092	4052487121910
	110	113	HSD150 1x110 b40 A4/EPDM55	1650015113	4052487121972
200	110	113	HSD200 1x110 b40 A4/EPDM55	1650020104	4052487122078
	114	119	HSD200 1x114 b40 A4/EPDM55	1650020114	4052487122139
	125	128	HSD200 1x125 b40 A4/EPDM55	1650020124	4052487122191
	133	136	HSD200 1x133 b40 A4/EPDM55	1650020134	4052487122252
	139	141	HSD200 1x139 b40 A4/EPDM55	1650020144	4052487122313
	159	163	HSD200 1x159 b40 A4/EPDM55	1650020154	4052487122375
250	159	163	HSD250 G 1x159 b40 A4/EPDM55	1650025154	4052487122474
	168	171	HSD250 G 1x168 b40 A4/EPDM55	1650025164	4052487122535
	177	181	HSD250 G 1x177 b40 A4/EPDM55	1650025174	4052487122597
	200	201	HSD250 G 1x200 b40 A4/EPDM55	1650025204	4052487122658
	210	211	HSD250 G 1x210 b40 A4/EPDM55	1650025214	4052487122719
300	198	202	HSD300 G 1x200 b40 A4/EPDM55	1650030204	4052487122818
	208	212	HSD300 G 1x210 b40 A4/EPDM55	1650030214	4052487122870
	217	221	HSD300 G 1x219 b40 A4/EPDM55	1650030224	4052487122931
	223	227	HSD300 G 1x225 b40 A4/EPDM55	1650030234	4052487122993
	248	252	HSD300 G 1x250 b40 A4/EPDM55	1650030254	4052487123051
400	273	276	HSD400 G 1x273 b40 A4/EPDM55	1650040274	4052487123112
	277	282	HSD400 G 1x277 b40 A4/EPDM55	1650040284	4052487123174
	315	321	HSD400 G 1x315 b40 A4/EPDM55	1650040314	4052487123235
	324	328	HSD400 G 1x324 b40 A4/EPDM55	1650040324	4052487123297
500	398	402	HSD500 G 1x400 b40 A4/EPDM55	1650050404	4052487123358
	427	431	HSD500 G 1x429 b40 A4/EPDM55	1650050434	4052487123419
	448	452	HSD500 G 1x450 b40 A4/EPDM55	1650050454	4052487123471

Press seals for pipes

STANDARD-PRESS SEALS

STANDARD PRESS SEAL HSD, A2/NBR55, Seal width 40 mm					
Core drill hole/ wall sleeve ID (mm)	Suitable for carrier pipe OD (mm)		Article code	Article number	GTIN
	from	to			
100	32	34	HSD100 1x32 b40 A2/NBR55	1650010033	4052487121354
	40	43	HSD100 1x40 b40 A2/NBR55	1650010041	4052487121415
	48	51	HSD100 1x48 b40 A2/NBR55	1650010049	4052487121477
	60	63,5	HSD100 1x60 b40 A2/NBR55	1650010061	4052487121538
125	60	63,5	HSD125 1x60 b40 A2/NBR55	1650012061	4052487121590
	75	77	HSD125 1x75 b40 A2/NBR55	1650012076	4052487121651
	78	81	HSD125 1x78 b40 A2/NBR55	1650012086	4052487121712
150	78	81	HSD150 1x78 b40 A2/NBR55	1650015079	4052487121835
	88	92	HSD150 1x88 b40 A2/NBR55	1650015089	4052487121897
	110	113	HSD150 1x110 b40 A2/NBR55	1650015111	4052487121958
200	110	113	HSD200 1x110 b40 A2/NBR55	1650020101	4052487122054
	114	119	HSD200 1x114 b40 A2/NBR55	1650020111	4052487122115
	125	128	HSD200 1x125 b40 A2/NBR55	1650020121	4052487122177
	133	136	HSD200 1x133 b40 A2/NBR55	1650020131	4052487122238
	139	141	HSD200 1x139 b40 A2/NBR55	1650020141	4052487122290
	159	163	HSD200 1x159 b40 A2/NBR55	1650020151	4052487122351
250	159	163	HSD250 G 1x159 b40 A2/NBR55	1650025151	4052487122450
	168	171	HSD250 G 1x168 b40 A2/NBR55	1650025161	4052487122511
	177	181	HSD250 G 1x177 b40 A2/NBR55	1650025171	4052487122573
	200	201	HSD250 G 1x200 b40 A2/NBR55	1650025201	4052487122634
	210	211	HSD250 G 1x210 b40 A2/NBR55	1650025211	4052487122696
300	198	202	HSD300 G 1x200 b40 A2/NBR55	1650030201	4052487122795
	208	212	HSD300 G 1x210 b40 A2/NBR55	1650030211	4052487122856
	217	221	HSD300 G 1x219 b40 A2/NBR55	1650030221	4052487122917
	223	227	HSD300 G 1x225 b40 A2/NBR55	1650030231	4052487122979
	248	252	HSD300 G 1x250 b40 A2/NBR55	1650030251	4052487123037
400	273	276	HSD400 G 1x273 b40 A2/NBR55	1650040271	4052487123099
	277	282	HSD400 G 1x277 b40 A2/NBR55	1650040281	4052487123150
	315	321	HSD400 G 1x315 b40 A2/NBR55	1650040311	4052487123211
	324	328	HSD400 G 1x324 b40 A2/NBR55	1650040321	4052487123273
500	398	402	HSD500 G 1x400 b40 A2/NBR55	1650050401	4052487123334
	427	431	HSD500 G 1x429 b40 A2/NBR55	1650050431	4052487123396
	448	452	HSD500 G 1x450 b40 A2/NBR55	1650050451	4052487123457

Press seals

STANDARD-PRESS SEALS

STANDARD PRESS SEAL HSD, A4/NBR55, Seal width 40 mm					
Core drill hole/ wall sleeve ID (mm)	Suitable for carrier pipe OD (mm) from to		Article code	Article number	GTIN
100	32	34	HSD100 1x32 b40 A4/NBR55	1650010037	4052487121385
	40	43	HSD100 1x40 b40 A4/NBR55	1650010045	4052487121446
	48	51	HSD100 1x48 b40 A4/NBR55	1650010053	4052487121507
	60	63,5	HSD100 1x60 b40 A4/NBR55	1650010065	4052487121569
125	60	63,5	HSD125 1x60 b40 A4/NBR55	1650012065	4052487121620
	75	77	HSD125 1x75 b40 A4/NBR55	1650012080	4052487121682
	78	81	HSD125 1x78 b40 A4/NBR55	1650012090	4052487121743
150	78	81	HSD150 1x78 b40 A4/NBR55	1650015083	4052487121866
	88	92	HSD150 1x88 b40 A4/NBR55	1650015093	4052487121927
	110	113	HSD150 1x110 b40 A4/NBR55	1650015114	4052487121989
200	110	113	HSD200 1x110 b40 A4/NBR55	1650020105	4052487122085
	114	119	HSD200 1x114 b40 A4/NBR55	1650020115	4052487122146
	125	128	HSD200 1x125 b40 A4/NBR55	1650020125	4052487122207
	133	136	HSD200 1x133 b40 A4/NBR55	1650020135	4052487122269
	139	141	HSD200 1x139 b40 A4/NBR55	1650020145	4052487122320
	159	163	HSD200 1x159 b40 A4/NBR55	1650020155	4052487122382
250	159	163	HSD250 G 1x159 b40 A4/NBR55	1650025155	4052487122481
	168	171	HSD250 G 1x168 b40 A4/NBR55	1650025165	4052487122542
	177	181	HSD250 G 1x177 b40 A4/NBR55	1650025175	4052487122603
	200	201	HSD250 G 1x200 b40 A4/NBR55	1650025205	4052487122665
	210	211	HSD250 G 1x210 b40 A4/NBR55	1650025215	4052487122726
300	198	202	HSD300 G 1x200 b40 A4/NBR55	1650030205	4052487122825
	208	212	HSD300 G 1x210 b40 A4/NBR55	1650030215	4052487122887
	217	221	HSD300 G 1x219 b40 A4/NBR55	1650030225	4052487122948
	223	227	HSD300 G 1x225 b40 A4/NBR55	1650030235	4052487123006
	248	252	HSD300 G 1x250 b40 A4/NBR55	1650030255	4052487123068
400	273	276	HSD400 G 1x273 b40 A4/NBR55	1650040275	4052487123129
	277	282	HSD400 G 1x277 b40 A4/NBR55	1650040285	4052487123181
	315	321	HSD400 G 1x315 b40 A4/NBR55	1650040315	4052487123242
	324	328	HSD400 G 1x324 b40 A4/NBR55	1650040325	4052487123303
500	398	402	HSD500 G 1x400 b40 A4/NBR55	1650050405	4052487123365
	427	431	HSD500 G 1x429 b40 A4/NBR55	1650050435	4052487123426
	448	452	HSD500 G 1x450 b40 A4/NBR55	1650050455	4052487123488

Press seals for pipes

STANDARD-PRESS SEALS

STANDARD PRESS SEAL HSD, A2/KTW55, Seal width 40 mm					
Core drill hole/ wall sleeve ID (mm)	Suitable for carrier pipe OD (mm)		Article code	Article number	GTIN
	from	to			
100	32	34	HSD100 1x32 b40 A2/KTW55	1650010034	4052487121361
	40	43	HSD100 1x40 b40 A2/KTW55	1650010042	4052487121422
	48	51	HSD100 1x48 b40 A2/KTW55	1650010050	4052487121484
	60	63,5	HSD100 1x60 b40 A2/KTW55	1650010062	4052487121545
125	60	63,5	HSD125 1x60 b40 A2/KTW55	1650012062	4052487121606
	75	77	HSD125 1x75 b40 A2/KTW55	1650012077	4052487121668
	78	81	HSD125 1x78 b40 A2/KTW55	1650012087	4052487121729
150	78	81	HSD150 1x78 b40 A2/KTW55	1650015080	4052487121842
	88	92	HSD150 1x88 b40 A2/KTW55	1650015090	4052487121903
	110	113	HSD150 1x110 b40 A2/KTW55	1650015112	4052487121965
200	110	113	HSD200 1x110 b40 A2/KTW55	1650020102	4052487122061
	114	119	HSD200 1x114 b40 A2/KTW55	1650020112	4052487122122
	125	128	HSD200 1x125 b40 A2/KTW55	1650020122	4052487122184
	133	136	HSD200 1x133 b40 A2/KTW55	1650020132	4052487122245
	139	141	HSD200 1x139 b40 A2/KTW55	1650020142	4052487122306
	159	163	HSD200 1x159 b40 A2/KTW55	1650020152	4052487122368
250	159	163	HSD250 G 1x159 b40 A2/KTW55	1650025152	4052487122467
	168	171	HSD250 G 1x168 b40 A2/KTW55	1650025162	4052487122528
	177	181	HSD250 G 1x177 b40 A2/KTW55	1650025172	4052487122580
	200	201	HSD250 G 1x200 b40 A2/KTW55	1650025202	4052487122641
	210	211	HSD250 G 1x210 b40 A2/KTW55	1650025212	4052487122702
300	198	202	HSD300 G 1x200 b40 A2/KTW55	1650030202	4052487122801
	208	212	HSD300 G 1x210 b40 A2/KTW55	1650030212	4052487122863
	217	221	HSD300 G 1x219 b40 A2/KTW55	1650030222	4052487122924
	223	227	HSD300 G 1x225 b40 A2/KTW55	1650030232	4052487122986
	248	252	HSD300 G 1x250 b40 A2/KTW55	1650030252	4052487123044
400	273	276	HSD400 G 1x273 b40 A2/KTW55	1650040272	4052487123105
	277	282	HSD400 G 1x277 b40 A2/KTW55	1650040282	4052487123167
	315	321	HSD400 G 1x315 b40 A2/KTW55	1650040312	4052487123228
	324	328	HSD400 G 1x324 b40 A2/KTW55	1650040322	4052487123280
500	398	402	HSD500 G 1x400 b40 A2/KTW55	1650050402	4052487123341
	427	431	HSD500 G 1x429 b40 A2/KTW55	1650050432	4052487123402
	448	452	HSD500 G 1x450 b40 A2/KTW55	1650050452	4052487123464

STANDARD-PRESS SEALS

STANDARD PRESS SEAL HSD, A4/KTW55, Seal width 40 mm					
Core drill hole/ wall sleeve ID (mm)	Suitable for carrier pipe OD (mm)		Article code	Article number	GTIN
	from	to			
100	32	34	HSD100 1x32 b40 A4/KTW55	1650010038	4052487121392
	40	43	HSD100 1x40 b40 A4/KTW55	1650010046	4052487121453
	48	51	HSD100 1x48 b40 A4/KTW55	1650010054	4052487121514
	60	63,5	HSD100 1x60 b40 A4/KTW55	1650010066	4052487121576
125	60	63,5	HSD125 1x60 b40 A4/KTW55	1650012066	4052487121637
	75	77	HSD125 1x75 b40 A4/KTW55	1650012081	4052487121699
	78	81	HSD125 1x78 b40 A4/KTW55	1650012091	4052487121750
150	78	81	HSD150 1x78 b40 A4/KTW55	1650015084	4052487121873
	88	92	HSD150 1x88 b40 A4/KTW55	1650015094	4052487121934
	110	113	HSD150 1x110 b40 A4/KTW55	1650015115	4052487121996
200	110	113	HSD200 1x110 b40 A4/KTW55	1650020106	4052487122092
	114	119	HSD200 1x114 b40 A4/KTW55	1650020116	4052487122153
	125	128	HSD200 1x125 b40 A4/KTW55	1650020126	4052487122214
	133	136	HSD200 1x133 b40 A4/KTW55	1650020136	4052487122276
	139	141	HSD200 1x139 b40 A4/KTW55	1650020146	4052487122337
	159	163	HSD200 1x159 b40 A4/KTW55	1650020156	4052487122399
250	159	163	HSD250 G 1x159 b40 A4/KTW55	1650025156	4052487122498
	168	171	HSD250 G 1x168 b40 A4/KTW55	1650025166	4052487122559
	177	181	HSD250 G 1x177 b40 A4/KTW55	1650025176	4052487122610
	200	201	HSD250 G 1x200 b40 A4/KTW55	1650025206	4052487122672
	210	211	HSD250 G 1x210 b40 A4/KTW55	1650025216	4052487122733
300	198	202	HSD300 G 1x200 b40 A4/KTW55	1650030206	4052487122832
	208	212	HSD300 G 1x210 b40 A4/KTW55	1650030216	4052487122894
	217	221	HSD300 G 1x219 b40 A4/KTW55	1650030226	4052487122955
	223	227	HSD300 G 1x225 b40 A4/KTW55	1650030236	4052487123013
	248	252	HSD300 G 1x250 b40 A4/KTW55	1650030256	4052487123075
400	273	276	HSD400 G 1x273 b40 A4/KTW55	1650040276	4052487123136
	277	282	HSD400 G 1x277 b40 A4/KTW55	1650040286	4052487123198
	315	321	HSD400 G 1x315 b40 A4/KTW55	1650040316	4052487123259
	324	328	HSD400 G 1x324 b40 A4/KTW55	1650040326	4052487123310
500	398	402	HSD500 G 1x400 b40 A4/KTW55	1650050406	4052487123372
	427	431	HSD500 G 1x429 b40 A4/KTW55	1650050436	4052487123433
	448	452	HSD500 G 1x450 b40 A4/KTW55	1650050456	4052487123495

Press seals for pipes

STANDARD-PRESS SEALS

HSD WITH NBR AND A2 (AISI 304L) OR A4 (AISI 316L)

The standard press seal HSD in NBR with A2 (AISI 304L) or A4 (AISI 316L) is always used where a high concentration of fuel and mineral oil is to be expected, e.g. at airports or filling stations. Due to its resilience to methane gas, NBR is also excellent suited for in connection with a gas storage tank in a biogas plant.



HSD WITH EPDM AND A4 (AISI 316L)

The press seal HSD in EPDM with A4 (AISI 316L) is ideal for use in difficult conditions – for example in treatment plants and digestion towers or in fermenters of biogas plants. In other words, wherever robust EPDM and high quality stainless steel are required.



HSD WITH KTW AND A2 (AISI 304L) OR A4 (AISI 316L)

The use of rubber according to the KTW guideline means that the standard press seal HSD can also be used in containers or buildings where there is contact with drinking water, e.g. in drinking water treatment plants or pump stations.



Krottenbach elevated tank, source:
wfw Zweckverband Wasserversorgung Fränkischer Wirtschaftsraum © Herbert Liedl

STANDARD PRESS SEAL SEALING WIDTH 80 MM

Features and technical data:

- for smooth and slightly corrugated district heating pipes
- for pipes with a pressure-sensitive surface
- for use in double walls/element walls
- gas-tight and watertight up to 0.5 bar
- available from stock
- visual and tangible installation reliability due to built-in inspection opening
- easy to install
- U-profile: maximum stability of the press segments
- low-impact sealing due to 80 mm seal width
- seal width 80 mm
- stainless steel A2 (AISI 304L)
- rubber quality in EPDM
- for core drill hole/wall sleeve up to 500 mm diameter
- pipe sizes OD 32 – 450 mm



HSD cross section



HSD500 1x450 b80 A2/EPDM55



Didn't find the right solution? See **from page 84 onwards**.

Press seals for pipes

STANDARD-PRESS SEALS

STANDARD PRESS SEAL HSD, A2/EPDM55, Seal width 80 mm					
Core drill hole/ wall sleeve ID (mm)	Suitable for carrier pipe OD (mm)		Article code	Article number	GTIN
	from	to			
100	32	34	HSD100 1x32 b80 A2/EPDM55	1600100321	4052487040327
	40	43	HSD100 1x40 b80 A2/EPDM	1600100401	4052487040341
	48	51	HSD100 1x48 b80 A2/EPDM	1600100481	4052487040365
	60	63,5	HSD100 1x60 b80 A2/EPDM55	1600100601	4052487040389
125	60	63,5	HSD125 1x60 b80 A2/EPDM55	1600200601	4052487040709
	75	77	HSD125 1x75 b80 A2/EPDM55	1600200751	4052487040723
	78	81	HSD125 1x78 b80 A2/EPDM55	1600200781	4052487040747
150	78	81	HSD150 1x78 b80 A2/EPDM55	1600300781	4052487040907
	88	92	HSD150 1x88 b80 A2/EPDM55	1600300881	4052487040921
	110	113	HSD150 1x110 b80 A2/EPDM55	1600300111	4052487040839
200	110	113	HSD200 1x110 b80 A2/EPDM55	1600400111	4052487040976
	114	119	HSD200 1x114 b80 A2/EPDM55	1600400115	4052487041010
	125	128	HSD200 1x125 b80 A2/EPDM55	1600400126	4052487041034
	133	136	HSD200 1x133 b80 A2/EPDM55	1600400134	4052487041096
	139	141	HSD200 1x139 b80 A2/EPDM55	1600400128	4052487041058
	159	163	HSD200 1x159 b80 A2/EPDM55	1600400127	4052487041041
250	159	163	HSD250 1x159 b80 A2/EPDM55	1600500203	4052487041317
	168	171	HSD250 1x168 b80 A2/EPDM55	1600500169	4052487041263
	177	181	HSD250 1x177 b80 A2/EPDM55	1600500202	4052487041300
	200	201	HSD250 1x200 b80 A2/EPDM55	1600500201	4052487041294
	210	211	HSD250 1x210 b80 A2/EPDM55	1600500211	4052487041331
300	198	202	HSD300 1x200 b80 A2/EPDM55	1600600201	4052487041430
	208	212	HSD300 1x210 b80 A2/EPDM55	1600600211	4052487041454
	217	221	HSD300 1x219 b80 A2/EPDM55	1600600220	4052487041478
	223	227	HSD300 1x225 b80 A2/EPDM55	1600600253	4052487041508
	248	252	HSD300 1x250 b80 A2/EPDM55	1600600254	4052487041515
400	273	276	HSD400 1x273 b80 A2/EPDM55	1600700274	4052487041560
	277	282	HSD400 1x277 b80 A2/EPDM55	1600700326	4052487041638
	315	321	HSD400 1x315 b80 A2/EPDM55	1600700316	4052487041607
	324	328	HSD400 1x324 b80 A2/EPDM55	1600700325	4052487041621
500	398	402	HSD500 1x400 b80 A2/EPDM55	1600800401	4052487041690
	427	431	HSD500 1x429 b80 A2/EPDM55	1600800430	4052487041713
	448	452	HSD500 1x450 b80 A2/EPDM55	1600800451	4052487041737

Press seals for pipes

STANDARD-PRESS SEALS



STANDARD PRESS SEAL, SEAL WIDTH 20 MM

Features and technical data:

- gas-tight and watertight up to 1 bar
- very diverse range of material combinations for customised solutions
- available from stock
- visual and tangible installation reliability due to built-in inspection opening
- easy to install
- can be split for retrofit on site installation
- U-profile: maximum stability of the press segments
- seal width 20 mm
- stainless steel A2 (AISI 304L) and A4 (AISI 316L)
- rubber quality in EPDM and available with KTW approval
- for core drill hole/wall sleeve up to 200 mm diameter
- pipe size 32 – 162 mm diameter



HSD200 1x159 b20 A2/EPDM55 "shaft seal"



HSD125 1x75 b20 A2/EPDM55 empty conduit connection



can be split on site

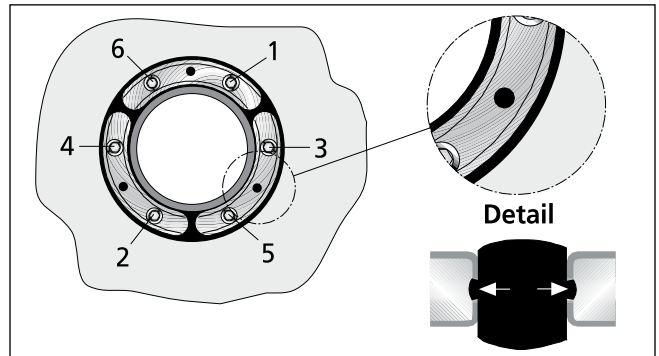

detail view – HSD
inspection opening and tightening order of screws



Press seals for pipes

STANDARD-PRESS SEALS

STANDARD PRESS SEAL HSD, A2/EPDM55, Seal width 20 mm					
Core drill hole/ wall sleeve ID (mm)	Suitable for carrier pipe OD (mm)		Article code	Article number	GTIN
	from	to			
100	32	34	HSD100 1x32 b20 A2/EPDM55	1650310032	4052487125109
	40	43	HSD100 1x40 b20 A2/EPDM55	1650310040	4052487125161
	48	51	HSD100 1x48 b20 A2/EPDM55	1650310048	4052487125222
	60	63,5	HSD100 1x60 b20 A2/EPDM55	1650310060	4052487125284
125	60	63,5	HSD125 1x60 b20 A2/EPDM55	1650312060	4052487125345
	75	77	HSD125 1x75 b20 A2/EPDM55	1650312075	4052487125406
	78	81	HSD125 1x78 b20 A2/EPDM55	1650312085	4052487125468
150	78	81	HSD150 1x78 b20 A2/EPDM55	1650315078	4052487125529
	88	92	HSD150 1x88 b20 A2/EPDM55	1650315088	4052487125581
	110	113	HSD150 1x110 b20 A2/EPDM55	1650315110	4052487125642
200	110	113	HSD200 1x110 b20 A2/EPDM55	1650320100	4052487125703
	114	119	HSD200 1x114 b20 A2/EPDM55	1650320110	4052487125765
	125	128	HSD200 1x125 b20 A2/EPDM55	1650320120	4052487125826
	133	136	HSD200 1x133 b20 A2/EPDM55	1650320130	4052487125888
	139	141	HSD200 1x139 b20 A2/EPDM55	1650320140	4052487125949
	159	163	HSD200 1x159 b20 A2/EPDM55	1650320150	4052487126007

Press seals for pipes

STANDARD-PRESS SEALS

STANDARD PRESS SEAL HSD, A4/EPDM55, Seal width 20 mm					
Core drill hole/ wall sleeve ID (mm)	Suitable for carrier pipe OD		Article code	Article number	GTIN
	from	to			
100	32	34	HSD100 1x32 b20 A4/EPDM55	1650310036	4052487125130
	40	43	HSD100 1x40 b20 A4/EPDM55	1650310044	4052487125192
	48	51	HSD100 1x48 b20 A4/EPDM55	1650310052	4052487125253
	60	63,5	HSD100 1x60 b20 A4/EPDM55	1650310064	4052487125314
125	60	63,5	HSD125 1x60 b20 A4/EPDM55	1650312064	4052487125376
	75	77	HSD125 1x75 b20 A4/EPDM55	1650312079	4052487125437
	78	81	HSD125 1x78 b20 A4/EPDM55	1650312089	4052487125499
150	78	81	HSD150 1x78 b20 A4/EPDM55	1650315082	4052487125550
	88	92	HSD150 1x88 b20 A4/EPDM55	1650315092	4052487125611
	110	113	HSD150 1x110 b20 A4/EPDM55	1650315113	4052487125673
200	110	113	HSD200 1x110 b20 A4/EPDM55	1650320104	4052487125734
	114	119	HSD200 1x114 b20 A4/EPDM55	1650320114	4052487125796
	125	128	HSD200 1x125 b20 A4/EPDM55	1650320124	4052487125857
	133	136	HSD200 1x133 b20 A4/EPDM55	1650320134	4052487125918
	139	141	HSD200 1x139 b20 A4/EPDM55	1650320144	4052487125970
	159	163	HSD200 1x159 b20 A4/EPDM55	1650320154	4052487126038

STANDARD PRESS SEAL HSD, A2/KTW55, Seal width 20 mm					
Core drill hole/ wall sleeve ID (mm)	Suitable for carrier pipe OD		Article code	Article number	GTIN
	from	to			
100	32	34	HSD100 1x32 b20 A2/KTW55	1650310034	4052487125123
	40	43	HSD100 1x40 b20 A2/KTW55	1650310042	4052487125185
	48	51	HSD100 1x48 b20 A2/KTW55	1650310050	4052487125246
	60	63,5	HSD100 1x60 b20 A2/KTW55	1650310062	4052487125307
125	60	63,5	HSD125 1x60 b20 A2/KTW55	1650312062	4052487125369
	75	77	HSD125 1x75 b20 A2/KTW55	1650312077	4052487125420
	78	81	HSD125 1x78 b20 A2/KTW55	1650312087	4052487125482
150	78	81	HSD150 1x78 b20 A2/KTW55	1650315080	4052487125543
	88	92	HSD150 1x88 b20 A2/KTW55	1650315090	4052487125604
	110	113	HSD150 1x110 b20 A2/KTW55	1650315112	4052487125666

Press seals for pipes

STANDARD-PRESS SEALS

STANDARD PRESS SEAL HSD, A2/KTW55, Seal width 20 mm					
Core drill hole/ wall sleeve ID (mm)	Suitable for carrier pipe OD		Article code	Article number	GTIN
	from	to			
200	110	113	HSD200 1x110 b20 A2/KTW55	1650320102	4052487125727
	114	119	HSD200 1x114 b20 A2/KTW55	1650320112	4052487125789
	125	128	HSD200 1x125 b20 A2/KTW55	1650320122	4052487125840
	133	136	HSD200 1x133 b20 A2/KTW55	1650320132	4052487125901
	139	141	HSD200 1x139 b20 A2/KTW55	1650320142	4052487125963
	159	163	HSD200 1x159 b20 A2/KTW55	1650320152	4052487126021

STANDARD PRESS SEAL HSD, A4/KTW5, Seal width 20 mm					
Core drill hole/ wall sleeve ID (mm)	Suitable for carrier pipe OD		Article code	Article number	GTIN
	from	to			
100	32	34	HSD100 1x32 b20 A4/KTW55	1650310038	4052487125154
	40	43	HSD100 1x40 b20 A4/KTW55	1650310046	4052487125215
	48	51	HSD100 1x48 b20 A4/KTW55	1650310054	4052487125277
	60	63,5	HSD100 1x60 b20 A4/KTW55	1650310066	4052487125338
125	60	63,5	HSD125 1x60 b20 A4/KTW55	1650312066	4052487125390
	75	77	HSD125 1x75 b20 A4/KTW55	1650312081	4052487125451
	78	81	HSD125 1x78 b20 A4/KTW55	1650312091	4052487125512
150	78	81	HSD150 1x78 b20 A4/KTW55	1650315084	4052487125574
	88	92	HSD150 1x88 b20 A4/KTW55	1650315094	4052487125635
	110	113	HSD150 1x110 b20 A4/KTW55	1650315115	4052487125697
200	110	113	HSD200 1x110 b20 A4/KTW55	1650320106	4052487125758
	114	119	HSD200 1x114 b20 A4/KTW55	1650320116	4052487125819
	125	128	HSD200 1x125 b20 A4/KTW55	1650320126	4052487125871
	133	136	HSD200 1x133 b20 A4/KTW55	1650320136	4052487125932
	139	141	HSD200 1x139 b20 A4/KTW55	1650320146	4052487125994
	159	163	HSD200 1x159 b20 A4/KTW55	1650320156	4052487126052

STANDARD PRESS SEAL WITH POWDER COATING

Features and technical data:

- gas-tight and watertight up to 2.5 bar
- available from stock
- visual and tangible installation reliability due to built-in inspection opening
- easy to install
- can be split for subsequent on site installation
- from 250 mm diameter split design
- U-profile: maximum stability of the press segments
- stainless steel A2 (AISI 304L), additionally powder coated, prevents corrosion when used in connection with galvanised wall sleeves
- rubber quality in EPDM



HSD200 C 1x159 b40 A2/EPDM55 in galvanised fixed/loose flange

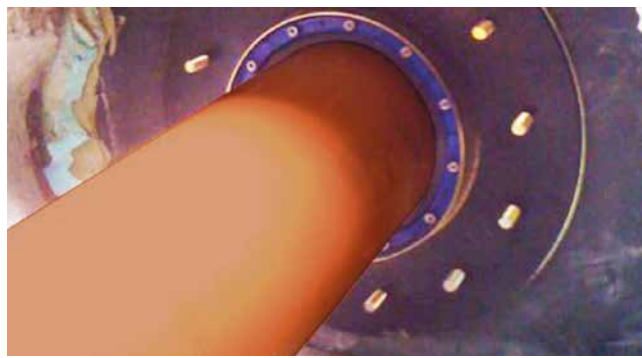

HSD200 C 1x159 b40 A2/EPDM55 in galvanised fixed/loose flange



HSD150 C 1x110 b40 A2/EPDM55 in galvanised fixed/loose flange



Press seals for pipes

STANDARD-PRESS SEALS

STANDARD PRESS SEAL HSD C, A2/EPDM55, Seal width 40 mm					
Core drill hole/ wall sleeve ID (mm)	Suitable for carrier pipe OD		Article code	Article number	GTIN
	from	to			
100	32	34	HSD100 C 1x32 b40 A2/EPDM55	1610100320	4052487042123
	40	43	HSD100 C 1x40 b40 A2/EPDM55	1610100400	4052487042130
	48	51	HSD100 C 1x48 b40 A2/EPDM55	1610100480	4052487042147
	60	63,5	HSD100 C 1x60 b40 A2/EPDM55	1610100600	4052487042154
125	60	63,5	HSD125 C 1x60 b40 A2/EPDM55	1610200600	4052487042284
	75	77	HSD125 C 1x75 b40 A2/EPDM55	1610200750	4052487042291
	78	81	HSD125 C 1x78 b40 A2/EPDM55	1610200780	4052487042307
150	78	81	HSD150 C 1x78 b40 A2/EPDM55	1610300780	4052487042369
	88	92	HSD150 C 1x88 b40 A2/EPDM55	1610300880	4052487042376
	110	113	HSD150 C 1x110 b40 A2/EPDM55	1610300110	4052487042352
200	110	113	HSD200 C 1x110 b40 A2/EPDM55	1610400110	4052487042390
	114	119	HSD200 C 1x114 b40 A2/EPDM55	1610400114	4052487042406
	125	128	HSD200 C 1x125 b40 A2/EPDM55	1610400125	4052487042413
	133	136	HSD200 C 1x133 b40 A2/EPDM55	1610400133	4052487042420
	139	141	HSD200 C 1x139 b40 A2/EPDM55	1610400139	4052487042437
	159	163	HSD200 C 1x159 b40 A2/EPDM55	1610400159	4052487042444

Additional designs/variants on request.

Press seals for pipes

STANDARD-PRESS SEALS

STANDARD PRESS SEAL HSD GC, A2/EPDM55, Seal width 40 mm					
Core drill hole/ wall sleeve ID (mm)	Suitable for carrier pipe OD from to		Article code	Article number	GTIN
250	159	163	HSD250 GC 1x159 b40 A2/EPDM55	1610500159	4052487042475
	168	171	HSD250 GC 1x168 b40 A2/EPDM55	1610500168	4052487042482
	177	181	HSD250 GC 1x177 b40 A2/EPDM55	1610500177	4052487042499
	200	201	HSD250 GC 1x200 b40 A2/EPDM55	1610500200	4052487042505
	210	211	HSD250 GC 1x210 b40 A2/EPDM55	1610500210	4052487042512
300	198	202	HSD300 GC 1x200 b40 A2/EPDM55	1610600200	4052487042529
	208	212	HSD300 GC 1x210 b40 A2/EPDM55	1610600210	4052487042536
	217	221	HSD300 GC 1x219 b40 A2/EPDM55	1610600219	4052487042543
	223	227	HSD300 GC 1x225 b40 A2/EPDM55	1610600225	4052487042550
	248	252	HSD300 GC 1x250 b40 A2/EPDM55	1610600250	4052487042567
400	273	276	HSD400 GC 1x273 b40 A2/EPDM55	1610700273	4052487042574
	277	282	HSD400 GC 1x277 b40 A2/EPDM55	1610700277	4052487042581
	315	321	HSD400 GC 1x315 b40 A2/EPDM55	1610700315	4052487042598
	324	328	HSD400 GC 1x324 b40 A2/EPDM55	1610700324	4052487042604
500	398	402	HSD500 GC 1x400 b40 A2/EPDM55	1610800400	4052487042611
	427	431	HSD500 GC 1x429 b40 A2/EPDM55	1610800429	4052487042628
	448	452	HSD500 GC 1x450 b40 A2/EPDM55	1610800450	4052487042635

Additional designs/variants on request.



STANDARD PRESS SEAL FOR RAINWATER UTILISATION SYSTEMS

Features and technical data:

- gas-tight and watertight up to 2.5 bar
- installation according to DIN 18533 in the relevant installation parts/flanges
- universal sealing for rainwater harvesting systems
- split seal for retrofit installation
- press seal may also be used as blind insert
- for core drills/wall sleeve with a diameter of 100 mm
- particularly suitable for storage thanks to the wide application range
- U-profile press segments made of stainless steel A2 (AISI 304L)
- visual and tangible installation reliability due to built-in inspection opening
- seal width 40 mm
- rubber quality in EPDM



STANDARD PRESS SEAL FOR BUILDING CONNECTIONS

Features and technical data:

- gas-tight and watertight up to 2.5 bar
- installation according to DIN 18533 in the relevant installation parts/flanges
- universal seal for water or electricity + communication
- press seal may also be used as a blind insert
- for core drills/wall sleeves with a diameter of 100 mm
- due to flexible application range perfect for stock-keeping
- U-profile press segments made of stainless steel A2 (AISI 304L)
- visual and tangible installation reliability due to built-in inspection opening
- seal width 40 mm
- rubber quality in EPDM



ADAPTER RING

Features and technical data:

- to increase the outer diameter of press seal HSD100 RW/HSD100 EW to 104 or 110 mm

Press seals for pipes

STANDARD-PRESS SEALS

HSD RW – STANDARD PRESS SEAL						
Figure	Number of cable/pipes	Cable/pipe diameter OD (mm)	Article code	Pieces in packing unit	Article number	GTIN
Standard press seal, Core drill hole/wall sleeve ID 100mm						
	4		HSD100 RW 1x25/32/40+3x6-18 b40 A2/...	1	3030300059	4052487112499
	of which 3	6 – 18				
	of which 1	25, 32, 40		5		4052487223720

HSD EW – STANDARD PRESS SEAL						
Figure	Number of cable/pipes	Cable/pipe diameter OD (mm)	Article code	Pieces in packing unit	Article number	GTIN
Standard press seal, Core drill hole/wall sleeve ID 100mm						
	5		HSD100 EW 1x24-44+4x7-12 b40 A2/EPDM	1	3030300054	4052487126250
	of which 4	7 – 12				
	of which 1	24 – 44		5		4052487221566

ACCESSORIES FOR STANDARD PRESS SEALS					
Figure	Core drill hole/wall sleeve ID (mm)	Article code	Pieces in packing unit	Article number	GTIN
Adapter ring					
	104	HSD ADR 100/104	1	3030300051	4052487040556
			15		4052487223683
	110	HSD ADR 100/110	1	3030300052	4052487223690
			15		4052487223706

CORRUGATED PIPE SEAL

PRESS SEAL SET FOR CORRUGATED CONDUITS AND PIPES

Features and technical data:

- gas-tight and watertight up to 0.5 bar
- visual and tangible installation reliability due to built-in inspection opening
- even contact pressure
- patented clip rings to stabilise the pipe
- no penetration of the sealing rubber into the pipe corrugation
- insulation ring centres the corrugated pipe in the core drill hole and forms a visual closure to the ring space on the inside of the building
- seal width 40 or 80 mm
- stainless steel A2 (AISI 304L)
- rubber quality in EPDM
- for core drill hole/wall sleeve up to 500 mm diameter



WRD200 1x125 A2/EPDM55 e.g. Kabuflex/Fränkische

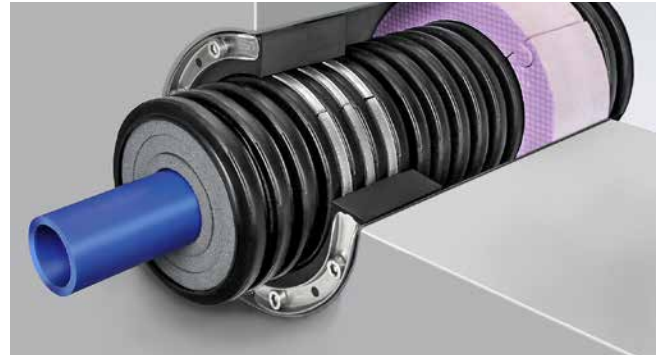

cross section of sealing set WRD



view of inside of building (insulation ring)

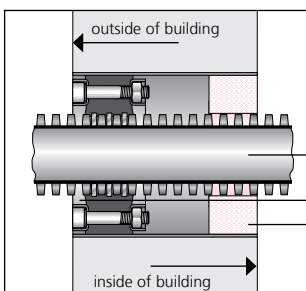

cross section
positioning in core drill hole

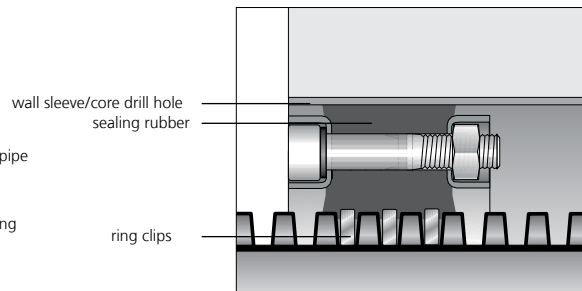

detail view
clip ring/ seal

Press seals for pipes

CORRUGATED PIPE SEAL

WRD				
Figure	Nominal width (mm)	Article code	Article number	GTIN
Core drill hole/wall sleeve ID 100 mm				
	63	WRD100 1x63 b40 A2/EPDM55 – Pipe type/pipe manufacturer	1610100063*	4052487042116*
Core drill hole/wall sleeve ID 125 mm				
	63	WRD125 1x63 b40 A2/EPDM55 – Pipe type/pipe manufacturer	1610125063*	4052487132534*
	75	WRD125 1x75 b40 A2/EPDM55 – Pipe type/pipe manufacturer	1610125075*	4052487042192*
Core drill hole/wall sleeve ID 150 mm				
	75	WRD150 1x75 b40 A2/EPDM55 – Pipe type/pipe manufacturer	1610150075*	4052487042208*
	90	WRD150 1x90 b40 A2/EPDM55 – Pipe type/pipe manufacturer	1610150090*	4052487042215*
	110	WRD150 1x110 b40 A2/EPDM55 – Pipe type/pipe manufacturer	1610150110*	4052487042222*
Core drill hole/wall sleeve ID 200 mm				
	110	WRD200 1x110 b40 A2/EPDM55 – Pipe type/pipe manufacturer	1610200110*	4052487042239*
	125	WRD200 1x125 b40 A2/EPDM55 – Pipe type/pipe manufacturer	1610200125*	4052487042253*
	160	WRD200 1x160 b80 A2/EPDM55 – Pipe type/pipe manufacturer	1610200160*	4052487042277*
Core drill hole/wall sleeve ID 250 mm				
	160	WRD250 1x160 b80 A2/EPDM55 – Pipe type/pipe manufacturer	1610250160*	4052487042314*
	200	WRD250 1x200 b80 A2/EPDM55 – Pipe type/pipe manufacturer	1610250300*	4052487181907*

*GTIN and article number depend on the type of pipe and pipe manufacturer.

Other sizes on request.

ACCESSORIES			
Figure	Article code	Article number	GTIN
Core drill hole sealant for coating drill hole walls			
	KBV 2K	354040001	4052487168533

Press seals for pipes

ATTACHABLE DUCT COLLAR

ATTACHABLE DUCT COLLAR WITH SEGMENTED RINGS

Features and technical data:

- waterproof concrete stress class 1, stress class 2
- DIN 18533 W1.1-E, W1.2-E, W2.1-E
- gas-tight and watertight up to 1 bar
- one component for three or five different pipe diameters
- for radial and axial movement
- flexible connection of pipes to core drill hole
- including stainless steel attachment elements
- for installation on earth side
- sealing collar made of EPDM
- jubilee clips made of stainless steel A2 (AISI 304L) 20 mm wide
- attachment ring in stainless steel A2 (AISI 304L)
- segmented ring technology
- axial distance ADM 150: 340 mm
- axial distance ADM 200: 390 mm
- attachment elements including sealing ring





ADM attachment duct collar segment sections



attachment duct collar ADM200 1x90/110/125/140/160

Press seals for pipes

ATTACHABLE DUCT COLLAR

ADM				
Figure	Application range for carrier pipe OD (mm)	Article code	Article number	GTIN
Core drill hole/wall sleeve ID max. 100 mm				
	75 – 110	ADM150 75/90/110	1400060150	4052487127530
Core drill hole/wall sleeve ID max. 200 mm				
	90 – 160	ADM200 90/110/125/140/160	1400061200	4052487126526

ACCESSORIES			
Figure	Article code	Article number	GTIN
290 ml cartridge, colour grey elastic sealant to optimise wall surface in combination with sealing flanges			
	EGO SMP805	5020050084	4052487238533

TUNDISH WITH STEP SAFE INSERT

Features and technical data:

- waterproof concrete stress class 1, stress class 2
- DIN 18533 W1.1-E, soil moisture
- gas-tight and watertight connection to the base slab thanks to integrated 3-ribbed seal
- KIWA approved
- made of radon-tight ABS polymer
- to connect waste water pipes and to compensate tolerances up to 90 mm (after concreting) in each direction between downpipe and floor entry
- saves rectangular recesses and therefore complex follow-up work
- simple on site installation
- including step protection insert according to DGUV 38 §12a
- can be used for base slab drainage during construction phase thanks to integrated dirt trap grooves
- with integrated level for position alignment of the tundish



difficulty: retrofit gas-tight and vapour-proof sealing



difficulty: integration of vapour barrier foil



easy integration of the vapour barrier using the adhesive ribbon

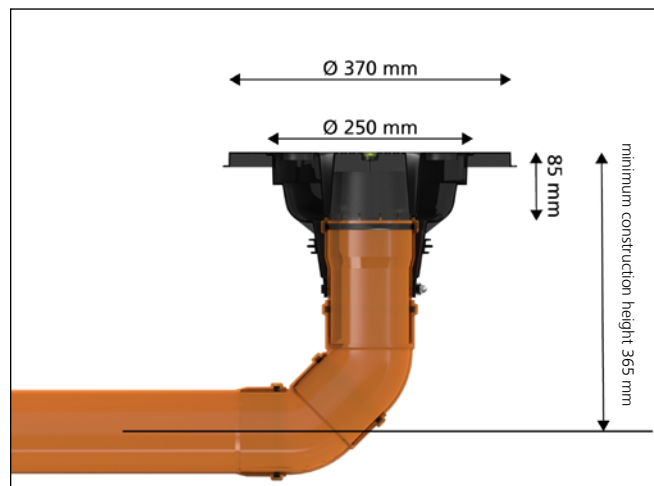

Waste water entries

FLOOR ENTRIES

AT110 – TUNDISH					
Figure	Suitable for diameter OD (mm)	Article code	Pieces in packing unit	Article number	GTIN
Waste water pipe tundish					
	110	AT110	1	827001601	4052487171663
			8		4052487224314
			32		4052487224321

Danger areas when installing without AT110:



please note: danger area, trip hazard



please note: no tight connection between rectangular recess and concrete and between waste water pipe and concrete

Advantages of installation with AT110:



firm underfoot and trip-free



gas-tight and watertight

Waste water entries

HAUFF WALL COLLAR KG-FIX

Features and technical data:

- waterproof concrete stress class 1, stress class 2
- gas-tight and watertight up to 2.5 bar
- quick, tool-less assembly
- high degree of dimensional stability due to high-quality ABS
- suitable for all standard smooth pipes
- KIWA-Bautest certified (3rd party accredited)



quick, tool-less assembly

WALL COLLAR:

Features and technical data:

- waterproof concrete stress class 1, stress class 2
- gas-tight and watertight up to 2.5 bar
- suitable for all standard smooth pipes
- 2 stainless chromium jubilee clips to tighten the wall collar
- water barrier flange made of EPDM
- KIWA-Bautest certified



Waste water entries
FLOOR ENTRIES

KG-FIX – HAUFF WALL COLLAR						
Figure	Wall collar OD (mm)	Suitable for diameter OD (mm)	Article code	Pieces in packing unit	Article number	GTIN
Hauff wall collar						
	212	110	KGF110	1	3030300095	4052487156721
				15		4052487220170
	227	125	KGF125	1	3030377635	4052487228855
				5		4052487239721
	262	160	KGF160	1	3030300098	4052487171625
				5		4052487220200

HMK – WALL COLLAR						
Figure	Wall collar OD (mm)	Suitable for diameter OD (mm)	Article code	Pieces in packing unit	Article number	GTIN
Hauff wall collar						
	213	120 – 130	HMK125	1	5060150801	4052487233286
				5		4052487233804
	228	135 – 148	HMK140	1	5060150802	4052487233279
				5		4052487233811
	282	195 – 210	HMK200	1	5060150804	4052487233262
				5		4052487233828

Waste water entries

*Scope of delivery: wall collar with 2 clamping straps made of stainless chromium steel.

ACCESSORIES – FOIL SLEEVE			
Figure	Article code	Article number	GTIN
Connection for waste water pipes/ducts			
	HFM 1x100-110	3030370212	4052487228053
	HFM 1x125-135	3030370213	4052487228060
	HFM 1x150-165	3030370214	4052487228077
	HFM 1x200-220	3030370215	4052487228084

UNIVERSAL WALL ENTRY WITHOUT JOINT EDGE

Features and technical data:

- waterproof concrete stress class 1, stress class 2
- DIN 18533 W1.1-E, W1.2-E, W2.1-E
- blind seal ready for installation, watertight up to 1 bar straight after concreting
- KIWA approved
- can be installed easily and quickly on site
- easy on site adjustment to required wall thickness (UDM)
- pre-assembled according to wall thickness (UDM/X)
- available for KG and KG 2000 pipes, OD 110 and 160 mm
- for installation flush with the formwork, no interruption of the flow direction (see graphic)
- with integrated sealing flange for the processing of polymer modified bituminous thick coatings

Conventional wall entry

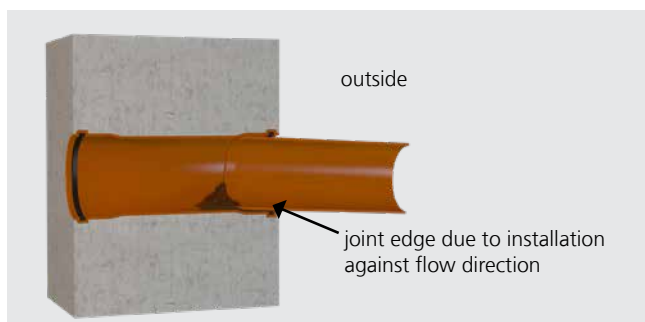

With conventional wall entries with double plug-in sleeves, the "flow of direction" is interrupted by the insert of the pointed end of the KG pipe on the outside of the buildings. In the case of slight settlement, which cannot be entirely ruled out in the working area, this forms a "joint edge". The result: deposits form on the edge which, over an extended period of time, can lead to a blockage in the waste water system.

Universal wall entry UDM by Hauff-Technik

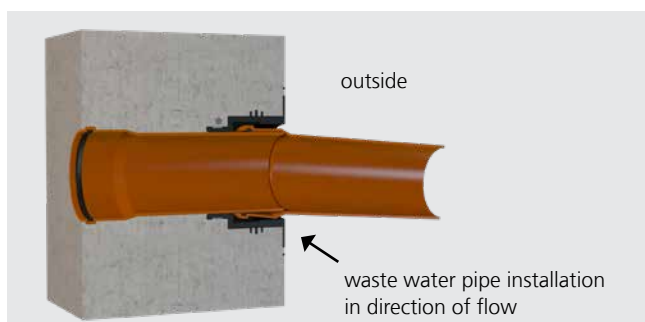

Thanks to the design of the UDM, there is no interruption in the flow direction. A "joint edge" does not develop if slight settlements occur which cannot be entirely eliminated in the area around the working space. The result: no deposits can build up, drainage is not affected.

Universal wall entry UDM in a concreted wall with outer sealing

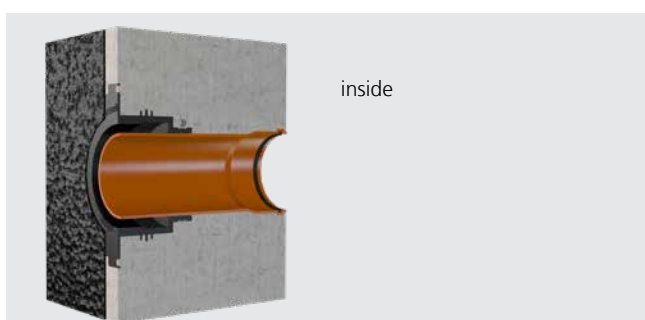

The integrated sealing flange allows simple application of surface seals according to DIN 18533 up to load case W2.1-E. No elaborate application of a chamfer is therefore required.

Waste water entries

WALL ENTRIES

UDM – UNIVERSAL WALL ENTRY						
Figure	Suitable for diameter OD (mm)	Wall thickness (mm)	Article code	Pieces in packing unit	Article number	GTIN
Universal wall entry without waste water pipe						
	110	ab 200	UDM100	1	3030300188	4052487215527
				24		4052487220613
	160	ab 240	UDM150	1	3030300204	4052487215688
				5		4052487220774

Lieferumfang: Gummimanschette (EPDM), Stahlspannband, Anspachtelflansch mit Blinddeckel zum Einschlagen, Verschlussdeckel

Universal wall entry with waste water pipe						
	110	200	UDM100/200 KG	1	3030300189	4052487215534
				8		4052487220620
		240	UDM100/240 KG	1	3030300191	4052487215558
				8		4052487220644
		250	UDM100/250 KG	1	3030300193	4052487215572
				8		4052487220668
		300	UDM100/300 KG	1	3030300195	4052487215596
				8		4052487220682
		365	UDM100/365 KG	1	3030300198	4052487215626
				8		4052487220712
		400	UDM100/400 KG	1	3030300200	4052487215640
				8		4052487220736
	500	UDM100/500 KG	1	3030300202	4052487215664	
			8		4052487220750	
	160	240	UDM150/240 KG	1	3030300205	4052487215695
				5		4052487220781
		250	UDM150/250 KG	1	3030300207	4052487215718
				5		4052487220804
		300	UDM150/300 KG	1	3030300210	4052487215749
				5		4052487220835
365		UDM150/365 KG	1	3030300213	4052487215770	
			5		4052487220866	
400		UDM150/400 KG	1	3030300215	4052487215794	
			5		4052487220880	
500	UDM150/500 KG	1	3030300217	4052487215817		
		5		4052487220903		

Scope of delivery: rubber sleeve (EPDM), clamping strap, sealing flange with blind plate to be knocked out, closing cover, waste water pipe OD 110 or 160 (pre-assembled)

WALL ENTRIES

UDM – UNIVERSAL WALL ENTRY						
Figure	Suitable for diameter OD (mm)	Wall thickness (mm)	Article code	Pieces in packing unit	Article number	GTIN
Universal wall entry with KG 2000 pipe						
	110	200	UDM100/200 KG2000	1	3030300190	4052487215541
				8		4052487220637
		240	UDM100/240 KG2000	1	3030300192	4052487215565
				8		4052487220651
		250	UDM100/250 KG2000	1	3030300194	4052487215589
				8		4052487220675
		300	UDM100/300 KG2000	1	3030300196	4052487215602
	8			4052487220699		
	365	UDM100/365 KG2000	1	3030300199	4052487215633	
			8		4052487220729	
	400	UDM100/400 KG2000	1	3030300201	4052487215657	
			8		4052487220743	
	500	UDM100/500 KG2000	1	3030300203	4052487215671	
			8		4052487220767	
160	240	UDM150/240 KG2000	1	3030300206	4052487215701	
			5		4052487220798	
	250	UDM150/250 KG2000	1	3030300208	4052487215725	
			5		4052487220811	
	300	UDM150/300 KG2000	1	3030300211	4052487215756	
			5		4052487220842	
	365	UDM150/365 KG2000	1	3030300214	4052487215787	
			5		4052487220873	
	400	UDM150/400 KG2000	1	3030300216	4052487215800	
			5		4052487220897	
	500	UDM150/500 KG2000	1	3030300218	4052487215824	
			5		4052487220910	

WALL ENTRIES

UNIVERSAL WALL ENTRY WITHOUT JOINT EDGE FOR INSTALLATION IN DOUBLE WALLS/ELEMENT WALLS

Features and technical data:

- waterproof concrete stress class 1, stress class 2
- DIN 18533 W1.1-E, W1.2-E, W2.1-E
- blind seal ready for installation, watertight up to 1 bar straight after concreting
- KIWA approved
- can be installed easily and quickly on site
- pre-assembled to wall thickness
- available for KG and KG 2000 pipes, OD 110 and 160
- for installation flush with the formwork, no interruption of the flow direction
- with integrated sealing flange for the processing of polymer modified bituminous thick coatings
- inclusive two additional mounted 3-ribbed seals for installation in double walls/element walls



Waste water entries

WALL ENTRIES

UDME – UNIVERSAL WALL ENTRY FOR DOUBLE WALLS/ELEMENT WALLS							
Figure	Suitable for diameter OD (mm)	Wall thickness (mm)	Article code	Pieces in packing unit	Article number	GTIN	
Universal wall entry for double wall/element wall with waste water pipe							
	110	240	UDME100/240 KG	1	3030300221	4052487215855	
				8		4052487220941	
		250	UDME100/250 KG	1	3030300223	4052487215879	
				8		4052487220965	
		300	UDME100/300 KG	1	3030300225	4052487215893	
				8		4052487220989	
		365	UDME100/365 KG	1	3030300228	4052487215923	
				8		4052487221016	
		400	UDME100/400 KG	1	3030300230	4052487215947	
				8		4052487221030	
	160	300	UDME150/300 KG	1	3030300237	4052487216029	
				5		4052487221108	
		365	UDME150/365 KG	1	3030300240	4052487216050	
				5		4052487221139	
		400	UDME150/400 KG	1	3030300242	4052487216074	
				5		4052487221153	
	Universal wall entry for double wall/element walls with waste water pipe 2000						
		110	240	UDME100/240 KG2000	1	3030300222	4052487215862
8					4052487220958		
250			UDME100/250 KG2000	1	3030300224	4052487215886	
				8		4052487220972	
300			UDME100/300 KG2000	1	3030300227	4052487215916	
				8		4052487221009	
365			UDME100/365 KG2000	1	3030300229	4052487215930	
				8		4052487221023	
400			UDME100/400 KG2000	1	3030300231	4052487215954	
				8		4052487221047	
160		300	UDME150/300 KG2000	1	3030300238	4052487216036	
				5		4052487221115	
		365	UDME150/365 KG2000	1	3030300241	4052487216067	
				5		4052487221146	
		400	UDME150/400 KG2000	1	3030300243	4052487216081	
				5		4052487221160	

Scope of delivery: rubber sleeve (EPDM), clamping strap, sealing flange with blind plate to be knocked out, closing cover, waste water pipe OD 110 or 160 (pre-assembled), 2 pre-assembled 3-ribbed seals.

EARTHING WALL COLLAR



Features and technical data:

- waterproof concrete stress class 1, stress class 2
- completely gas-tight and watertight
- suitable for all commonly used earthing conductors
- 2 clamping straps W1 for fixing the wall collar
- water barrier through a flange made of EPDM
- KIWA-Bautest certified



Extra

EARTHING ENTRIES

HMK – EARTHING WALL COLLAR						
Figure	Wall collar OD (mm)	Suitable for conductor cross-section OD/lxb (mm)	Article code	Pieces in packing unit	Article number	GTIN
Earthing wall collar for cylindrical conductors						
	105	8 – 10	HMK8-10	1	3030300037	4052487194068
				50		4052487223539
Earthing wall collar for flat conductors						
	120	30 x 3,5	HMK30*3,5	1	3030303257	4052487222020
				10		4052487197137

Scope of delivery: Wall Collar with 2 clamping straps (W1)

ACCESSORIES – FOIL SLEEVE			
Figure	Article code	Article number	GTIN
Connection for round earthing conductors			
	HFM 1x4-8	3030370203	4052487227971
	HFM 1x8-12	3030370204	4052487227988

Extra

EARTHING ENTRIES

EARTHING ENTRY

Features and technical data:

- waterproof concrete stress class 1, stress class 2
- conductor core diameter 25 mm with a threaded connection on both sides M12, made of stainless steel A4 (AISI 316L), HEA > 200 mm also available with connecting thread M16
- pressure-tight water barrier (profiled rubber flange, NBR)
- contact plate diameter 72 mm made of stainless steel A4 (AISI 316L)
- protective covers made of PE with four nail holes
- conductor core for HEA > 200 mm connection via M16 bolts, galvanized
- no twisting after installation in concrete
- according to DIN 18014, DIN EN 62305-3 VDE 0185-305-3 (with lightning protection)

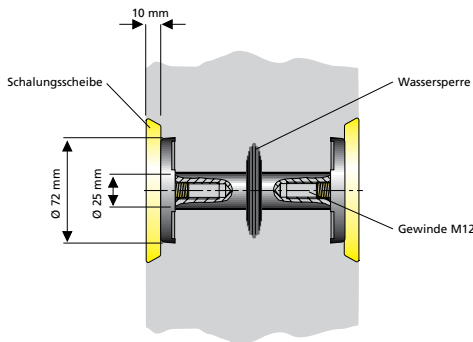

e.g. HEA M12/100



e.g. HEA M12/240

INSULATED EARTHING ENTRY

Features and technical data:

- waterproof concrete stress class 1, stress class 2
- conductor core diameter 25 mm with a threaded connection on both sides M12, made of stainless steel A2 (AISI 304L)
- pressure-tight water barrier (profiled rubber flange, EPDM)
- contact plate diameter 72 mm made of stainless steel A4 (AISI 316L)
- with protective cover
- minimum wall thickness HEA IS: max. 70 mm
- according to VDE 0101, EN 50522
- short-circuit tested (with lightning protection)

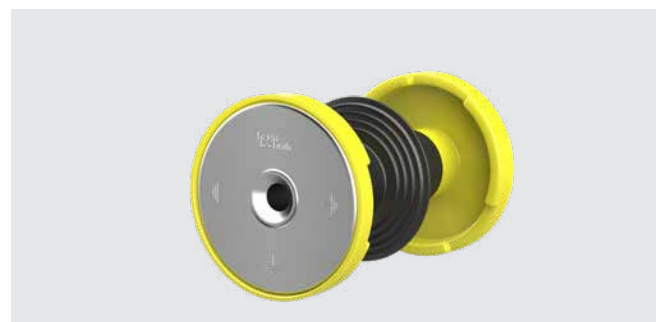
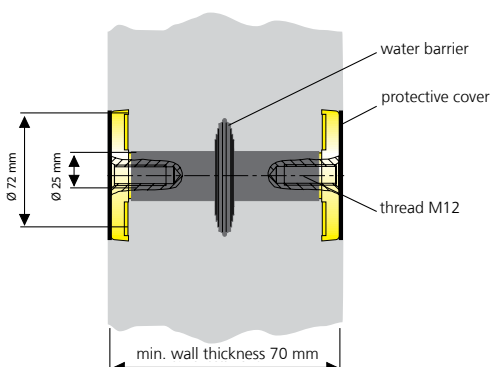

e.g. HEA IS M12/100

Extra

EARTHING ENTRIES

HEA M – ENTRY FOR EARTHING IN CONCRETE			
Item	Article code	Article number	GTIN
Entry for earthing connections made of stainless steel A4 (AISI 316L), connection M 12 on both sides, with water barrier and protective foils, for wall thickness 70 mm	HEA M12/70	1700010070	4052487044479
Entry for earthing connections made of stainless steel A4 (AISI 316L), connection M 12 on both sides, with water barrier and protective covers, for wall thickness 100 mm	HEA M12/100	1700010100	4052487044493
Entry for earthing connections made of stainless steel A4 (AISI 316L), connection M 12 on both sides, with water barrier and protective covers, for wall thickness 150 mm	HEA M12/150	1700010150	4052487044509
Entry for earthing connections made of stainless steel A4 (AISI 316L), connection M 12 on both sides, with water barrier and protective covers, for wall thickness 200 mm	HEA M12/200	1700010200	4052487044516
Entry for earthing connections made of stainless steel A4 (AISI 316L), connection M 12 on both sides, with water barrier and protective covers, available for wall thicknesses 210 – 500 mm	X = wall thickness (mm) HEA M12/X	on request	on request
Entry for earthing connections made of stainless steel A4 (AISI 316L), connection M 16 on both sides, with water barrier and protective covers, available for wall thicknesses 210 – 500 mm	HEA M16/200	1700020020	4052487044530

Increments of 10 mm possible

HEA IS M12 – INSULATED EARTHING ENTRY FOR SUBSTATION			
Item	Article code	Article number	GTIN
Insulated feedthrough for earthing connections made of stainless steel A4 (AISI 316L), connection M12 on both sides, with water barrier and protective cover (HEA IS M12) for wall thickness 100 mm	HEA IS M12/100	1710020100	4052487045308
Insulated feedthrough for earthing connections made of stainless steel A4 (AISI 316L) connection M12 on both sides, with water barrier and protective cover (HEA IS M12) for wall thickness 150 mm	HEA IS M12/150	1710020150	4052487045360
Insulated feedthrough for earthing connections made of stainless steel A4 (AISI 316L) connection M12 on both sides, with water barrier and protective cover (HEA IS M12) for wall thickness 200 mm	HEA IS M12/200	1710020156	4052487045384
Insulated feedthrough for earthing connections made of stainless steel A4 (AISI 316L) connection M12 on both sides, with water barrier and protective cover (HEA IS M12) for wall thickness 250 mm	HEA IS M12/250	1710020157	4052487045391

Increments of 10 mm possible

Extra

EARTHING ENTRIES

EARTHING ENTRY WITH TERMINAL LUG AND CROSS CLAMP

Features and technical data:

- waterproof concrete stress class 1, stress class 2
- conductor core diameter 25 mm with a threaded connection on both sides M12/M16, made of stainless steel A4 (AISI 316L)
- terminal lug with cross clamp 70 x 70 mm made of steel St tzn
- pressure-tight water barrier (profiled rubber flange, NBR)
- contact plate diameter 72 mm made of stainless steel A4 (AISI 316L)
- protective covers made of PE with four nail holes
- minimum wall thickness 150 mm
- conductor core connection with M16 threaded bolts, galvanized
- according to DIN 18014, DIN EN 62305-3 VDE 0185-305-3 (with lightning protection)

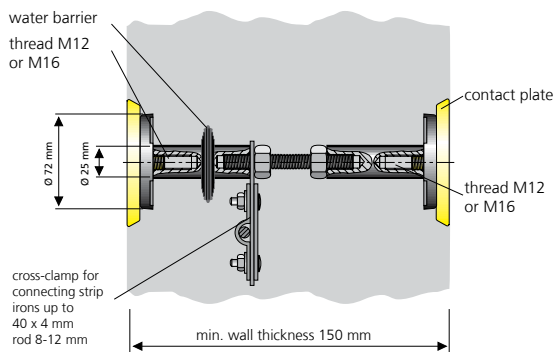

HEA PK M12/X

EARTHING ENTRY FOR RETROFIT INSTALLATION

Features and technical data:

- waterproof concrete stress class 1, stress class 2
- M16 threaded rod made of stainless steel A4 (AISI 316L) with sealing on both sides
- contact plate diameter 72 mm made of stainless steel A4 (AISI 316L)
- terminal lug with cross clamp for FL 40 x 4 mm or rod 10 – 12 mm
- suitable for wall thicknesses up to 600 mm, bigger wall thicknesses on request
- suitable for bore holes diameter 18 – 22 mm
- according to DIN 18014, DIN EN 62305-3 VDE 0185-305-3 (with lightning protection)

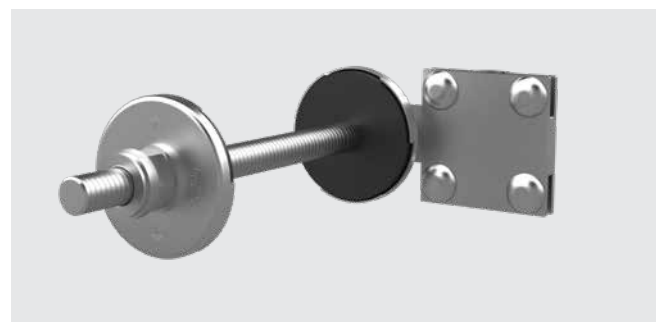
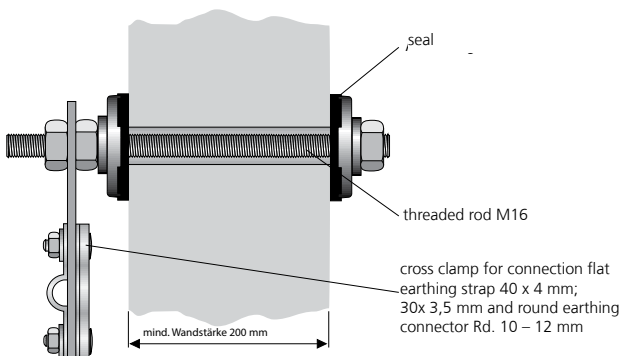

HEA N M16/X

Extra

EARTHING ENTRIES

HEA PK – EARTHING CONNECTION AND ENTRY			
Item	Article code	Article number	GTIN
Entry for earthing connections made of stainless steel A4 (AISI 316L), connection M12 on both sides, with terminal lug and cross clamp, available for wall thicknesses 150 – 500 mm, with water barrier and protective covers	HEA PK M12/X	on request	on request
Entry for earthing connections made of stainless steel A4 (AISI 316L), connection M16 on both sides, with terminal lug and cross clamp, available for wall thicknesses 150 – 500 mm, with water barrier and protective covers	HEA PK M16/X	on request	on request

X = wall thickness (mm)

Increments of 10 mm possible
Short circuit-proof up to 10 KA/1s (VDE 0101/E DIN EN 50522)

HEA N – ENTRY FOR RETROFIT INSTALLATION			
Item	Article code	Article number	GTIN
Entry for earthing connections, M16, stainless steel A4 (AISI 316L), for wall thicknesses up to 200 mm for retrofit installation	HEA N M16/200	1700050010	4052487044592
Entry for earthing connections, M16, stainless steel A4 (AISI 316L), for wall thicknesses up to 600 mm for retrofit installation	HEA N M16/600	1700050020	4052487044608
Entry for earthing connections, M16, stainless steel A4 (AISI 316L), for walls with perimeter insulation up to 200 mm, for wall thicknesses up to 400 mm for retrofit installation	HEA ND M16/400	1700050120	4052487044615

EARTHING ENTRIES

EARTHING ENTRY FOR BLACK TANK

Eigenschaften und technische Daten:

- for buildings with external sealing according to DIN 18533 W2.2-E (fixed/loose flange, diameter 210 mm)
- conductor core diameter 25 mm made of stainless steel A4 (AISI 316L) with threaded connection on both sides M12/M16 and additional cross clamp M20 as an external connection made of stainless steel A4 (AISI 316L)
- conductor core connection with M16 threaded bolts and lock nuts, galvanized
- contact plate diameter 72 mm made of stainless steel A4 (AISI 316L)
- protective covers made of PE with four nail holes
- minimum wall thickness 180 mm
- according to DIN 18014, DIN EN 62305-3 VDE 0185-305-3 (with lightning protection)

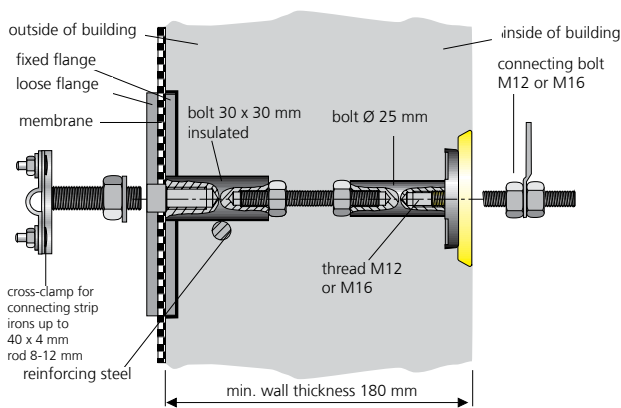

HEA W M12/X

EARTHING ENTRY FOR DOUBLE WALLS/ELEMENT WALLS

Features and technical data:

- waterproof concrete stress class 1, stress class 2
- conductor core diameter 25 mm with a threaded connection on both sides M12 made of stainless steel A4 (AISI 316L)
- conductor core connection with M16 threaded bolts, galvanized
- 2 water barriers (profiled rubber flange, NBR) and 1 additional seal on the threaded bolt, the position of which can be adapted on site
- contact plates diameter 72 mm made of stainless steel A4 (AISI 316L)
- protective covers made of PE with four nail holes
- minimum wall thickness 180 mm
- according to DIN 18014, DIN EN 62305-3 VDE 0185-305-3 (with lightning protection)

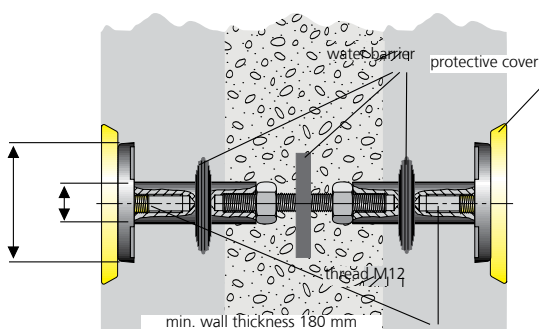

HEA EW M12/X

Extra

EARTHING ENTRIES

HEA W – ENTRY FOR BLACK TANK			
Item	Article code	Article number	GTIN
Earthing entry for buildings with external sealing according to DIN 18533 W2.2-E, (fixed/loose flange, diameter 210 mm), internal connection M12, cross clamp with threaded bolt M20 (minimum wall thickness 180 mm)	HEA W M12/X	on request	on request
Entry HEA W/x for buildings with external sealing according to DIN 18533 W2.2-E, (fixed/loose flange, diameter 210 mm), internal connection M16, cross clamp with threaded bolt M20 (minimum wall thickness 180 mm)	HEA W M16/X	on request	on request

X = wall thickness (mm)

HEA EW – ENTRY FOR DOUBLE WALLS/ELEMENT WALLS			
Item	Article code	Article number	GTIN
Entry for earthing connections made of stainless steel A4 (AISI 316L), connection M12 on both sides, with 3 water barriers and protective covers (minimum wall thickness 180 mm)	HEA EW M12/180	1700020510	4052487127639
	HEA EW M12/190	1700020520	4052487127646
	HEA EW M12/200	1700020530	4052487127653
	HEA EW M12/240	1700020570	4052487127660
	HEA EW M12/250	1700020580	4052487127677
	HEA EW M12/300	1700020630	4052487127684
	HEA EW M12/360	1700020690	4052487127691
	HEA EW M12/400	1700020695	4052487129497

EARTHING ENTRIES

FLEXIBLE EARTHING ENTRY

Features and technical data:

- waterproof concrete stress class 1, stress class 2
- conductor core diameter 25 mm made of stainless steel A4 (AISI 316L) with threaded connection on both sides M12 or M16
- pressure-tight water barrier (profiled rubber flange, NBR)
- contact plate diameter 72 mm made of stainless steel A4 (AISI 316L)
- protective covers made of PE with four nail holes
- for wall thicknesses up to 600 mm, thicker walls on request
- HEA F: Cu ground strap 50 mm², finely stranded, insulated
- HEA PF: with steel cable diameter 10 mm galvanized, can be fastened to reinforcement bars with cross clamp KKL
- according to DIN 18014, DIN EN 62305-3 VDE 0185-305-3 (with lightning protection)

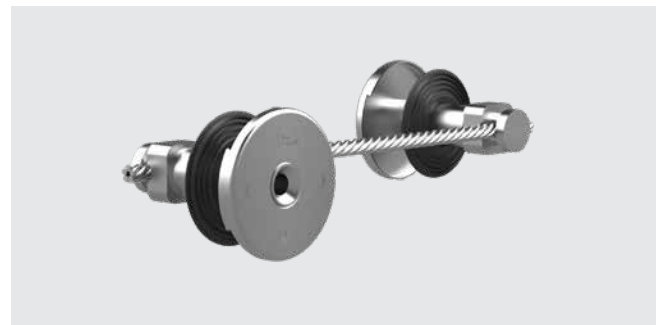
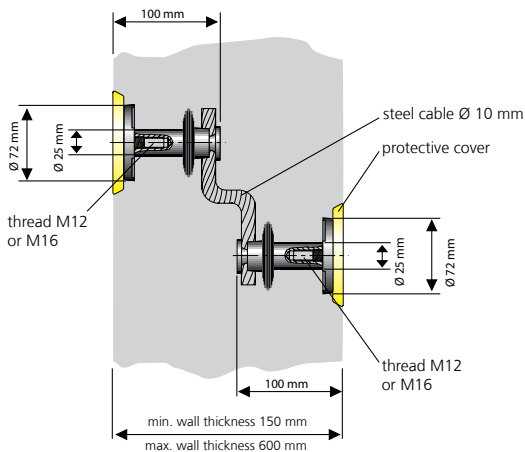



HEA PF M12/X

variant: HEA PF

Extra





EARTHING ENTRIES



HEA PF – FLEXIBLE EARTHING ENTRY			
Item	Article code	Article number	GTIN
Flexible earthing entry with steel cable diameter 10 mm galvanized and connection thread M12 for wall thickness up to 600 mm	HEA PF M12/600	1700060010	4052487044622
Flexible earthing entry with steel cable diameter 10 mm galvanized and connection thread M16 for wall thickness bis 600 mm	HEA PF M16/600	1700060020	4052487044639

ACCESSORIES			
Figure	Article code	Article number	GTIN
Terminal lug for connecting earthing conductors, equipotential bus bar or lightning protection technology, lug stainless steel A4 (AISI 316L), with connection screw M12			
	HEA ASL M12 A4	1700170010	4052487044950
Terminal lug for connecting earthing conductors, equipotential bus bar or lightning protection technology, lug stainless steel A4 (AISI 316L), with connection screw M16			
	HEA ASL M16 A4	1700170020	4052487044967
Adhesive tape, cold-welding, length 3 m, width approximately 35 mm, suitable as corrosion protection for earthing connectors			
	Hatetherm Scapa 0485	316010000	4052487006668

Extra





EARTHING ENTRIES

ACCESSORIES			
Figure	Article code	Article number	GTIN
Connection bolt M12 with U-washer, lockwasher and nut galvanized (St tzn)			
	HEA ASB M12 St-tzn	1700110010	4052487044769
Connection bolt M16 with U-washer, lockwasher and nut galvanized (St tzn)			
	HEA ASB M16 St-tzn	1700110020	4052487044776
Connection bolt M12 with U-washer, lockwasher and nut made of A4 (AISI 316L)			
	HEA ASB M12 A4	1700110040	4052487044790
Connection bolt M16 with U-washer, lockwasher and nut made of A4 (AISI 316L)			
	HEA ASB M16 A4	1700110050	4052487044806

ACCESSORIES			
Figure	Article code	Article number	GTIN
Cross clamp with screw-on threaded bolt M12 made of steel, hot-dip galvanized (St tzn)			
	HEA KKL M12 St-tzn	1700120030	4052487044875
Cross clamp with screw-on threaded bolt M12 made of stainless steel A4 (AISI 316L)			
	HEA KKL M12 A4	3030300276	4052487216418
Cross clamp with screw-on threaded bolt M16 made of stainless steel A4 (AISI 316L)			
	HEA KKL M16 A4	1700120020	4052487044868

Extra

EARTHING ENTRIES

ACCESSORIES			
Figure	Article code	Article number	GTIN
Cross clamp with screw-on threaded bolt M12 made of stainless steel A4 (AISI 316L), for buildings with perimeter insulation up to 80 mm			
	HEA KKL DM M12 A4	1700130010	4052487044882
Cross clamp with screw-on threaded bolt M16 made of stainless steel A4 (AISI 316L), for perimeter insulation up to 80 mm			
	HEA KKL DM M16 A4	1700130020	4052487044899
Connecting terminal 70 x 70 mm made of St tzn hot-dip galvanized for flat earthing strap 40 x 4 mm or round cable connector 8 – 12 mm			
	HEA AKL St-tzn	1700140010	4052487044905
Connecting terminal 70 x 70 mm made of stainless steel A4 (AISI 316L), for flat earthing strap 40 x 4 mm or round cable connector 8 – 12 mm			
	HEA AKL A4	1700140020	4052487044912

Extra

EARTHING FIXED POINTS

EARTHING FIXED POINT WITH CROSS CLAMP

- waterproof concrete stress class 1, stress class 2
- conductor core, diameter 25 mm with threaded connection M12/M16 made of stainless steel A4 (AISI 316L)
- cross clamp 70 x 70 mm with threaded bolt M12 or M16 galvanized
- contact plate diameter 72 mm made of stainless steel A4 (AISI 316L)
- protective covers made of PE with four nail holes
- minimum wall thickness 200 mm
- spacing between formwork and earth connection approximately 120 mm
- according to DIN 18014, DIN EN 62305-3 VDE 0185-305-3 (with lightning protection)

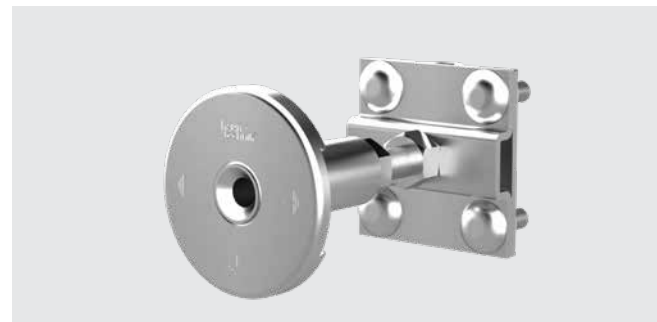
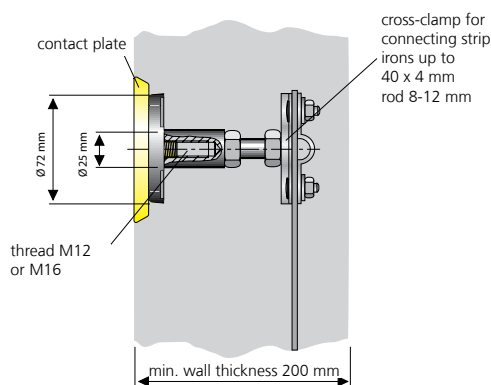

HEA P M12

EARTHING FIXED POINT WITH WELD GROOVE

Features and technical data

- waterproof concrete stress class 1, stress class 2
- conductor core, diameter 25 mm with threaded connection M12 made of stainless steel A2 (AISI 304L)
- fixed point with welded groove made of steel St tzn to connect with 10 – 12 mm round steel
- contact plate diameter 72 mm made of stainless steel A2 (AISI 304L)
- protective foil green transparent
- spacing between formwork and the core iron 50 mm (HEA A M12/50) or 70 mm (HEA A M12/70)
- short-circuit tested according to VDE 0101, EN 50522

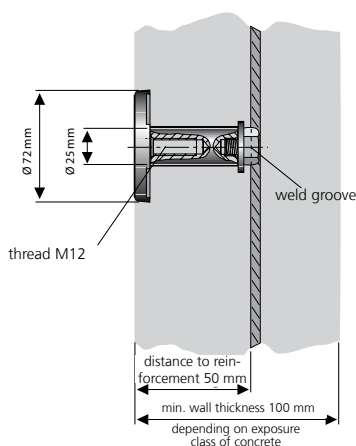

Extra

EARTHING FIXED POINTS

HEA P M12/HEA P M16 – FIXED POINT WITH CROSS CLAMP			
Item	Article code	Article number	GTIN
Connection piece with screw-on cross clamp for connection in concrete, connection M12, made of stainless steel A4 (AISI 316L), with protective cover, installation length = 120 mm	HEA P M12	1700100010	4052487044745
Connection piece with screw-on cross clamp for connection in concrete, connection M16, made of stainless steel A4 (AISI 316L), with protective cover, installation length = 120 mm	HEA P M16	1700100020	4052487044752

HEA A M12 – FIXED POINT WITH WELD GROOVE			
Item	Article code	Article number	GTIN
Connection piece in stainless steel A2 (AISI 304L) with weld groove in St tzn, conductor core diameter 25 mm, connection M12, for distances between formwork and core iron of 50 mm	HEA A M12/50	1700300500	4052487124140
Fixed point made of stainless steel A2 (AISI 304L) with weld groove made of steel St tzn, conductor core diameter 25 mm, connection M12, for distances between formwork and the core iron 70 mm	HEA A M12/70	1700300520	4052487131407

Extra

EARTHING FIXED POINTS

CONNECTION PIECE WITH WELD OR CLAMP CONNECTION

Features and technical data

- waterproof concrete stress class 1, stress class 2
- conductor core, diameter 25 mm with threaded connection M12/M16 made of stainless steel A4 (AISI 316L)
- steel rod diameter 12 mm made of steel St tzn for welded or clamped connection in concrete
- contact plate diameter 72 mm made of stainless steel A4 (AISI 316L)
- protective covers made of PE with four nail holes
- according to DIN 18014, DIN EN 62305-3 VDE 0185-305-3 (with lightning protection)

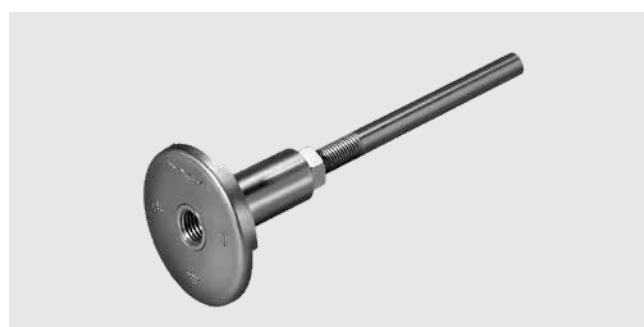
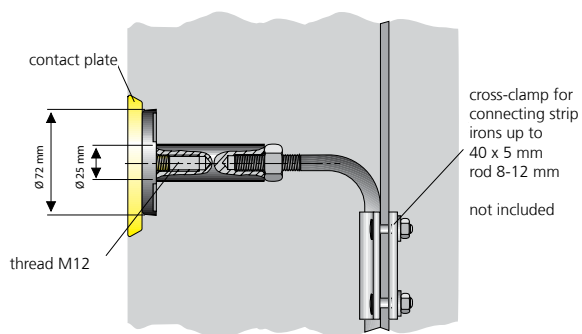

HEA S M12

Extra

EARTHING FIXED POINTS

HEA S M12/HEA S M16 – FIXED POINT WITH WELD OR CLAMP CONNECTION			
Item	Article code	Article number	GTIN
Connection piece in stainless steel A4 with screw-on steel rod St tzn, diameter 12 mm, connection M12, for weld or clamp connection in concrete	HEA S M12	1700080010	4052487044677
Connection piece in stainless steel A4 with screw-on steel rod St tzn, diameter 12 mm, connection M16, for weld or clamp connection in concrete	HEA S M16	1700080020	4052487044691

Extra

Extra

GAS-TIGHT AND WATERTIGHT FIRE BARRIER S90



FIRE PROTECTION KIT S90 FOR CORE DRILLS AND WALL SLEEVES

Features and technical data:

- fire protection S90 according to DIN 4102
- for core drill hole ID 70 – 200 mm
- for polymer wall sleeve ID 80 – 200 mm
- for wall insert HSI150 (maximum package 2 x 6)
- insulation thickness 280 mm
- minimum wall thickness 150 mm, no additional wall attachments necessary
- no limits on individual cable diameters
- pads assembly possible from one side
- high degree of flexibility as regards subsequent assignment
- no additional coating of cables necessary





HSS – installation fire-stop pads in wall insert HSI150-K2, sealing with system cover or SEGMENTO

APPLICATION TABLE HSS



System HSS	HRD 150/160 for HSI150	SEG = SEGMENTO	D / DG system cover	Core drill hole/wall sleeve (with HRD)
Wall thickness (mm)	≥ 150	≥ 240	≥ 240	≥ 150
Cable configuration	results from sealing system selection			
Total insulation thickness (mm)	280	440	440	280
Size (mm)	after block assembly HSI150 (max. 2-row, 6 pieces in a row)			diameter 70 (80) – 200
Tightness (bar)	to 2.5	0.5	to 2.5	to 5
Insulation thickness (mm)	200	200	200	50
Cable type	all cables and cross sections except for wave guides – no cable cross section limitation			
Installation	in masonry, concrete or aerated concrete walls			
Comment	configuration is limited by the sealing systems			

Extra

GAS-TIGHT AND WATERTIGHT FIRE BARRIER S90

HSS – FIRE PROTECTION SET AND TOOLS				
Figure	Core drill hole/wall sleeve ID (mm)	Article code	Article number	GTIN
Approval no: Z-19.15-1906 – fire protection S90				
Gas-tight fire protection set in conjunction with HRD comprising fire-stop pads 2x HVS K250, 3x HVS KB60, 1x label, stainless steel belt				
	up to 100	HSS100 KB FR HRD	5030010032	4052487233569
Gas-tight fire protection set in conjunction with HRD comprising: fire-stop pads 2x HV K400, 3x HVS K250, 3x HVS KB 60, 1x label, stainless steel belt				
	up to 150	HSS150 KB FR HRD	5030010033	4052487233545

HRD rubber press seal not included.

HSS UNIVERSAL FIRE-RESISTANT SEALING FOR CABLE ENTRY HSI150				
Figure	Sealing	Article code	Article number	GTIN
Approval no: Z-19.15-1906 – fire protection S90				
Gas-tight fire protection set in conjunction with system sealing HSI150 comprising: fire-stop pads 1x HVS K720, 1x HVS K400, 4x HVS K250/2, 4x HVS KB 60, abel, stainless steel belt				
 e.g. HSS150/DG	SEGMENTO/Systemdeckel	HSS150 HSI150	5030010030	4052487233606
Gas-tight fire protection set in conjunction with system sealing HSI150 comprising: fire-stop pads 2x HVS K400, 3x HVS K250, 3x HVS KB-60, abel, stainless steel belt				
	HRD- Ringraum- dichtung	HSS150 HSI150 HRD	5030010031	4052487233583

Delivery without HRD rubber press seal, SEGMENTO respectively system cover.

Extra

Extra

GAS-TIGHT AND WATERTIGHT FIRE BARRIER S90

DIBT approval
Z-19.15-1906 (HSS)
purs. to DIN 4102-9
General Type Approval
Z.19.53-2563

FIRE PROTECTION KIT S90 FOR CORE DRILLS AND WALL SLEEVES

Features and technical data:

- fire protection S90 according to DIN 4102
- for core drill hole ID 70 – 200 mm
- for polymer wall sleeve ID 80 – 200 mm
- for wall insert HSI150 (maximum package 2 x 6)
- insulation thickness 280 mm
- minimum wall thickness 150 mm, no additional wall attachments necessary
- no limits on individual cable diameters
- pads assembly possible from one side
- high degree of flexibility as regards subsequent assignment
- no additional coating of cables necessary



HSS – installation in core drill hole with HRD press seals

Extra

GAS-TIGHT AND WATERTIGHT FIRE BARRIER S90

HVS FIRE PROTECTION S90 PAD FIREWALL SYSTEM FOR CORE DRILL HOLE AND WALL SLEEVES

Figure	Core drill hole/wall sleeve ID (mm)	Article code	Article number	GTIN
--------	-------------------------------------	--------------	----------------	------

Approval no: Z-19.15-1906 – Brandschutz S90

Fire protection set comprising:
fire-stop pad 3x HVS K250/2, 5x HVS KB 60, 1x label, 2x stainless steel belt



bis Ø 100

HVS KK100

5030010010

4052487233675

Fire protection set comprising:
fire-stop pad 2x HVS K400, 5x HVS K250/2, 6x HVS-KB 60, 1x label, 2x stainless steel belt



bis Ø 150

HVS KK150

5030010011

4052487233651

Fire protection set comprising:
fire-stop pad 2x HVS K720, 2x HVS K400, 5x HVS K250/2, 8x HVS KB 60, 1x label, 4x stainless steel belt



bis Ø 150

HVS KK200

5030010012

4052487233637

HRD rubber press seal not included.

ACCESSORIES

Figure	Article code	Article number	GTIN
--------	--------------	----------------	------

Fitting panel for close-fitting installation of HVS/HSS fire-stop pads



HVS/HSS MBL

2600024100

4052487132145

Extra

ROOF ENTRIES

SWAN NECK ENTRY

Features and technical data:

- flexible, modular system suitable for all flat roof structures
- segmented components to reduce weight and ease the transport
- height (min. 300 mm) and orientation can be adjusted (can be swivelled through 360°) even after installation
- available in four sizes, diameter 100, 150, 200 and 300 mm all steel parts of swan neck hot-dip galvanized
- sealing of cables in swan neck after installing the cables possible with split sealing insert SKD (press plate made of stainless steel A2 (AISI 304L), rubber quality EPDM)



swan neck entry SHD200 complete with seal insert SKD



installed SHD200 before laying of cables

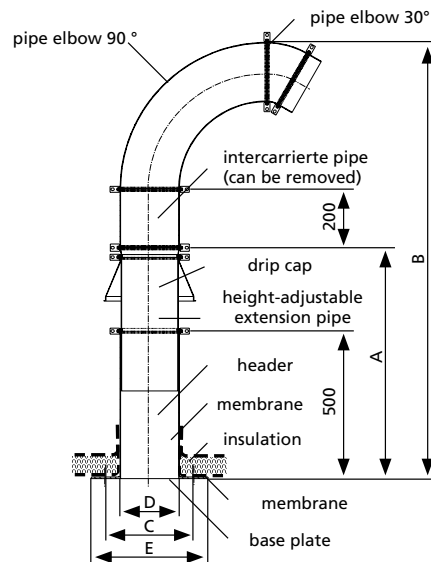









- A = min./max. telescope range
- B = overall height
- C = hole pattern 4 x 12 mm diameter
- D = ID max. core drill hole
- E = base plate edge dimension

TYPE	A (mm)	B (mm)	C (□ mm)	D (ID mm)	E (□ mm)
	Telescopic range min./max.	Total height	Hole pattern 4 x 12 mm diameter	Max. core drill hole	Base plate edge size
SHD100	600 – 950	1050 – 1400	250	100	300
SHD150	600 – 950	1175 – 1525	300	150	350
SHD200	600 – 950	1300 – 1650	350	200	400
SHD300	600 – 950	1550 – 1900	450	300	500

Extra

ROOF ENTRIES

SHD – SWAN NECK ROOF ENTRY			
Figure	Article code	Article number	GTIN
Swan neck entry, nominal width = 100 mm, for dowelling via core drill hole, 360° pivotable, height-adjustable			
	SHD100 fvz	1001094300	4052487025829
Swan neck entry, nominal width = 150 mm, for dowelling via core drill hole, 360° pivotable, height-adjustable			
	SHD150 fvz	1001094500	4052487025843
Swan neck entry, nominal width = 200 mm, for dowelling via core drill hole, 360° pivotable, height-adjustable			
	SHD200 fvz	1001094000	4052487025805
Swan neck entry, nominal width = 300 mm, for dowelling via core drill hole, 360° pivotable, height-adjustable			
	SHD300 fvz	1001095000	4052487025867

SKD – SWAN NECK CABLE SEAL			
Figure	Article code	Article number	GTIN
SKD100 (press plates made of stainless steel A2 (AISI 304L) EPDM)			
	SKD100 G zxd b60 A2/EPDM55	on request	on request
SKD150 (press plates made of stainless steel A2 (AISI 304L) EPDM)			
	SKD150 G zxd b60 A2/EPDM55	on request	on request
SKD200 (press plates made of stainless steel A2 (AISI 304L) EPDM)			
	SKD200 G zxd b60 A2/EPDM55	on request	on request
SKD300 (press plates made of stainless steel A2 (AISI 304L) EPDM)			
	SKD300 G zxd b60 A2/EPDM55	on request	on request

z = number of cables
d = measured cable diameter

FOUNDATION PIPES

FOUNDATION PIPE FOR STREET LIGHTING POLES

Features and technical data:

- foundation pipe, e.g. for masts, fence posts and flag posts
- low weight, thus easy handling
- ribbed polymer design
- resistant to corrosion and chemicals
- high stability and long service life
- available in nominal diameters 300, 400 and 500 mm
- individual lengths available
- cover available as protection against dirt
- posts can be installed at any point in time during construction
- damaged posts can easily be replaced

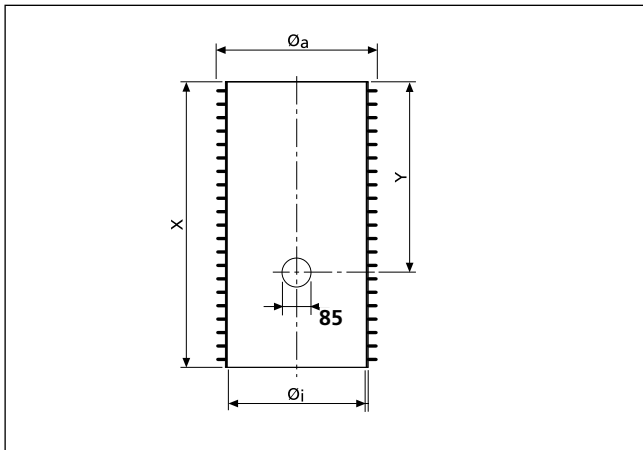

technical details

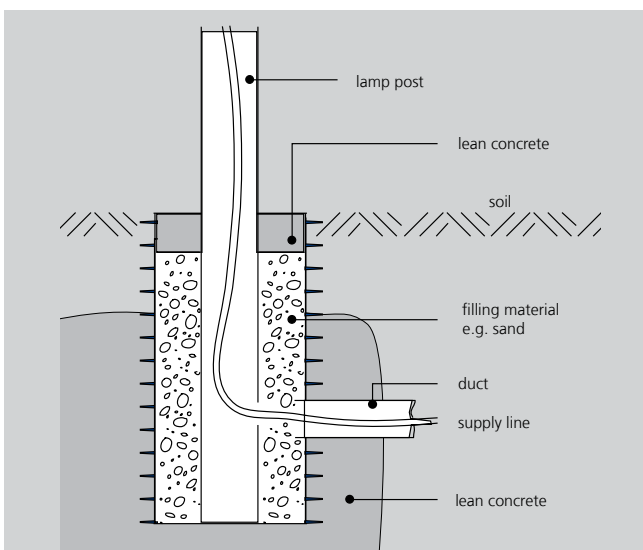
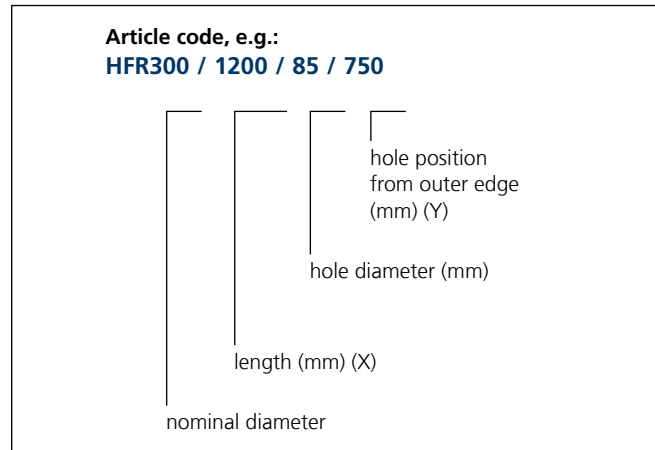

cross-section



Extra

FOUNDATION PIPES

HFR – FOUNDATION PIPE FOR STREET LIGHTING POLES			
Item	Article code	Article number	GTIN
Foundation pipe: ID = 290 mm, OD = approx. 335 mm			
Foundation pipe, pipe length = 600 mm	HFR300 I600 1x85/400	915000100	4052487023658
Foundation pipe, pipe length = 800 mm	HFR300 I800 1x85/600	915000200	4052487023672
Foundation pipe, pipe length = 1.000 mm	HFR300 I1000 1x85/600	915000250	4052487023702
Foundation pipe, pipe length = 1.200 mm	HFR300 I1200 1x85/600	915000300	4052487023740
Foundation pipe: ID = 390 mm, OD = approx. 450 mm			
Foundation pipe, pipe length = 800 mm	HFR400 I800 1x85/600	916000200	4052487023870
Foundation pipe, pipe length = 1.000 mm	HFR400 I1000 1x85/600	916000250	4052487023894
Foundation pipe, pipe length = 1.200 mm	HFR400 I1200 1x85/600	916000300	4052487023931
Foundation pipe, pipe length = 1.400 mm	HFR400 I1400 1x85/600	916000400	4052487023962
Foundation pipe: ID = 490 mm, OD = approx. 560 mm			
Foundation pipe, pipe length = 800 mm	HFR500 I800 1x85/600	918000200	4052487024068
Foundation pipe, pipe length = 1.000 mm	HFR500 I1000 1x85/600	918000250	4052487024082
Foundation pipe, pipe length = 1.200 mm	HFR500 I1200 1x85/600	918000300	4052487024105
Foundation pipe, pipe length = 1.400 mm	HFR500 I1400 1x85/600	918000400	4052487024129
Foundation pipe, pipe length = 1.600 mm	HFR500 I1600 1x85/600	918000500	4052487024150

ACCESSORIES			
Item	Article code	Article number	GTIN
PE cover for HFR 300 for protection against dirt	HFR300 VD	5190020013	4052487233361
PE cover for HFR 400 for protection against dirt	HFR400 VD	5190113980	4052487233354
PE cover for HFR 500 for protection against dirt	HFR500 VD	5199990020	4052487233521

FOIL SLEEVE

Features and technical data:

- securely connects an entry to a radon foil, vapour barrier foil or other seal on the slab
- gastight, airtight, radon-proof
- prevents convection and the resulting ingress of radon gas into the building
- versions suitable for a building entry, earth conductors and pipes/ducts
- quick and easy installation on site
- excellent adhesive strength

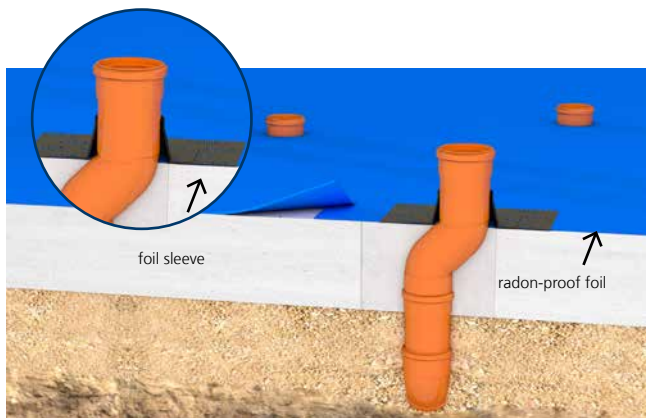

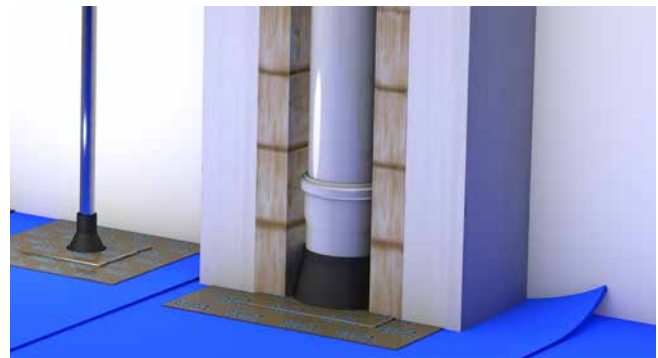

Retrofitting of a seal for a rectangular recess with radon foil and radon foil sleeve.



Extra
ACCESSORIES

FOIL SLEEVE			
Figure	Article code	Article number	GTIN
Connection for round earthing conductors			
	HFM 1x4-8	3030370203	4052487227971
	HFM 1x8-12	3030370204	4052487227988
Connection for pipes/ducts			
	HFM 1x15-22	3030370206	4052487227995
	HFM 1x25-32	3030370207	4052487228008
	HFM 1x32-40	3030370208	4052487228015
	HFM 1x40-55	3030370209	4052487228022
	HFM 1x50-72	3030370210	4052487228039
Connection for waste water pipes/ducts			
	HFM 1x72-90	3030370211	4052487228046
	HFM 1x100-110	3030370212	4052487228053
	HFM 1x125-135	3030370213	4052487228060
	HFM 1x150-165	3030370214	4052487228077
	HFM 1x200-220	3030370215	4052487228084
	HFM 1x230-250	3030370217	4052487228091

ACCESSORIES			
Figure	Article code	Article number	GTIN
Squeegee for gluing the foil sleeves			
	HFM APR	3030370823	4052487238519
Adhesive primer, for use as an undercoat on porous, absorbent, mineral surfaces for attaching the foil sleeves, contents: 250 ml			
	HFM P	3030375457	4052487238526

Extra

Single building entries – open construction

WALL ENTRY, ABOVE GROUND

FOR FIBRE OPTIC CABLES FROM 7 – 12 MM

Features and technical data:

- universal building entry above the ground, for drill holes in most common wall types
- for holes ID 20 mm
- horizontal installation or with an inclination of up to 45 °
- quick installation in just a few minutes

Scope of supply/sales unit:

- 10 x building entries
- 20 x wall plugs and screws
- 1x sealant EGO FLOTT

Necessary accessories:

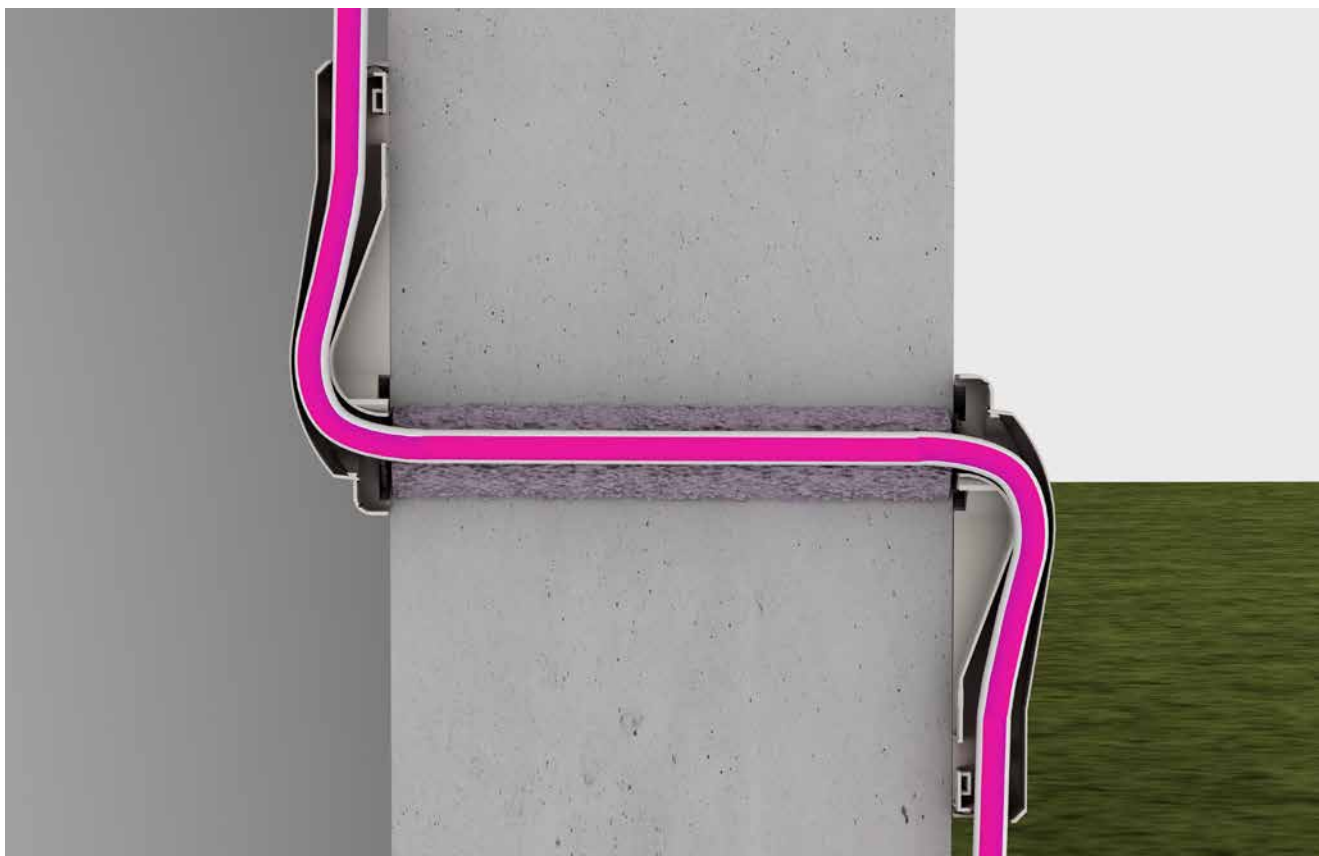

- cartridge gun



Single building entries – open construction

WALL ENTRY, ABOVE GROUND

OHE – Above-ground building entry				
Figure	Suitable for carrier pipe OD (mm)	Article code	Article number	GTIN
	7 – 12	OHE 1x7-12 SET10	3030340562	4052487228121

ACCESSORIES				
Figure	Article	Article code	Article number	GTIN
	1-component sealant EGO FLOTT	EGO FLOTT	3030376512	4052487238922
	Cartridge gun for resin injection	MIS MW	5060050021	4052487236454



Accessories can be found from page 184 onwards.

Single building entries – open construction

WALL ENTRY, RESIN INJECTION SYSTEM

FOR COMMUNICATION CABLES/FIBRE OPTIC CABLES

Features and technical data:

- waterproof concrete stress class 1, stress class 2
- DIN 18533 W1.1-E, W1.2-E
- universal building entry with resin injection system for drill holes in most common wall types
- for holes ID 20 mm, minimum wall thicknesses 200 mm
- horizontal installation or with an inclination of up to 45 °
- sealing lips ensure gentle seal for micropipes
- quick installation in just a few minutes
- gas-tight and watertight up to 1 bar

Scope of supply/sales unit:

- 1x GFH20
- 1x installation disc
- suitable number of pipe clamps, as per variant
- 1x wall connection element (only in Set PRO)
- 1x Hauff-2-component resin RESINATOR, 60ml

Necessary accessories:

- cartridge gun "GFH MW Side-by-Side"

Example

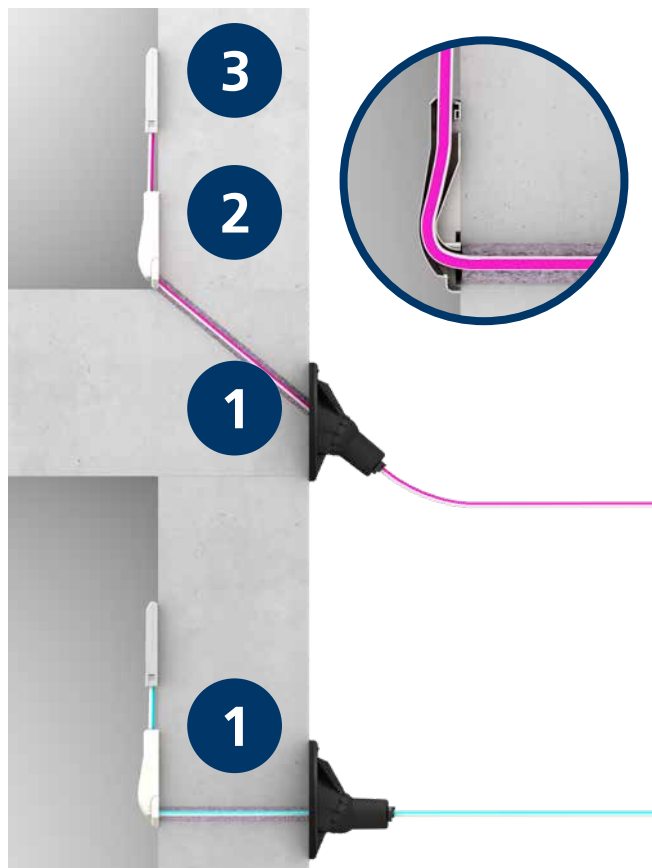

1. Fibre optic building entry GFH20 for laying micropipes through the wall or the base plate
2. Wall connection element including radius holder
3. Demarcation point for FTTH connection

Single building entries – open construction

WALL ENTRY, RESIN INJECTION SYSTEM

GFH20 SET PRO – FIBRE OPTIC BUILDING ENTRY					
Figure	Number of cables/ carrier lines	Suitable for carrier pipe OD (mm)	Article code	Article number	GTIN
	2	7 – 10*	GFH20 2x7-10 PRO	2900001311	4052487209823
	1	12 – 16	GFH20 1x12-16 PRO	2900001315	4052487209861
	1	6 – 13	GFH20 1x6-13 PRO	2900001313	4052487209847

* Ø22mm when 2x10mm



Accessories can be found from page 184 onwards.

Single building entries – open construction

WALL ENTRY, RESIN INJECTION SYSTEM

FOR COMMUNICATION CABLES/FIBRE OPTIC CABLES

Features and technical data:

- waterproof concrete stress class 1, stress class 2
- DIN 18533 W1.1-E, W1.2-E, W2.1-E
- universal building entry with resin injection system for drill holes in most common wall types
- for holes ID 30 mm, minimum wall thicknesses 200 mm
- horizontal installation or with an inclination of up to 45 °
- sealing lips ensure gentle seal for micropipes
- quick installation in just a few minutes
- restoration of basement waterproofing according to DIN 18533 W2.1-E is not necessary
- gas-tight and watertight up to 1 bar

Scope of supply/sales unit:

- 10 x GFH30
- 10 x 2-component resin Resinator, 60 ml
- 10 x wall connection element

Necessary accessories:

- cartridge gun "Side-by-Side"

Example:

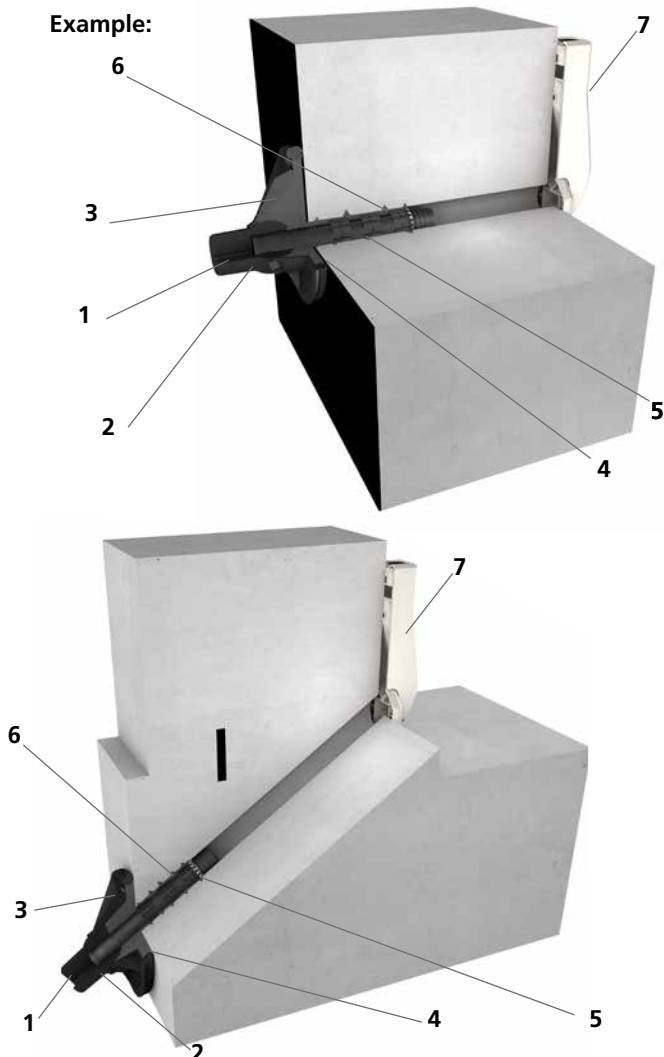



1. Sealing lips
2. Ball head with integrated snap-in sleeve for receiving the punching pin.
3. Flange with joint covers the wall break-through, ties in the building seal on the outer wall, and allows a horizontal or inclined installation. The resin is injected through a filler opening at the flange.
4. Butyl tape ensures a tightly sealed connection between the wall surface/building seal and the flange.
5. Punching pin with stays to hold it securely in the drill hole.
6. Expanded 2-component resin fills the spaces between the flange and the wall surface/building seal and between the drill hole and punching pin, including any blowholes and cavities, and creates a reliable seal.
7. Wall connection element ensures a tidy finish on the inside of the building.

Single building entries – open construction

WALL ENTRY, RESIN INJECTION SYSTEM

GFH30 – FIBRE OPTIC BUILDING ENTRY					
Figure	Number of cables/ carrier lines	Suitable for carrier pipe OD (mm)	Article code	Article number	GTIN
	2	7 – 10	GFH30 2x7-10 VE10	3030380157	4052487229975
	1	6 – 13	GFH30 1x6-13 VE10	3030380158	4052487229968
	1	12 – 16	GFH30 1x12-16 VE10	3030380159	4052487229951

ACCESSORIES					
Figure	Item	Article code	Article number	GTIN	
	PE corrugated pipe DN23 black empty conduit system for connecting or extending the GFH30, 50 m coil	WR23 S50000	5130031010	4052487235556	
	Wall bracket for PE corrugated pipe DN23 black sales unit = 50 pieces	WH DN23	5199990028	4052487235143	



More accessories can be found from page 184 onwards.

Single building entries – open construction

WALL ENTRY, RESIN INJECTION SYSTEM

FOR COMMUNICATION

Features and technical data:

- waterproof concrete, stress class 1, stress class 2
- DIN 18533 W1.1-E, W1.2-E, W2.1-E
- universal building entries with membrane injection system for drill holes in the wall
- sealing lips ensure gentle seal for carrier lines
- controlled ejection of resin through slit membrane hose
- quickly installed in just a few minutes
- no restoration of basement seal to DIN 18533 W2.1-E is necessary
- suitable for core drill hole ID 40 to 50 mm
- gas-tight and watertight up to 1 bar

Scope of supply/sales unit:

- 10 x MIS40
- 10 x wall connection element
- 10 x 2-component resin Resinator, 150 ml
- 1 x quick tensioning device MIS40 SVS

Necessary accessories:

- cartridge gun "Side-by-Side"

Article code, article number and other, optional accessories can be found **from page 184 onwards**.

Example:

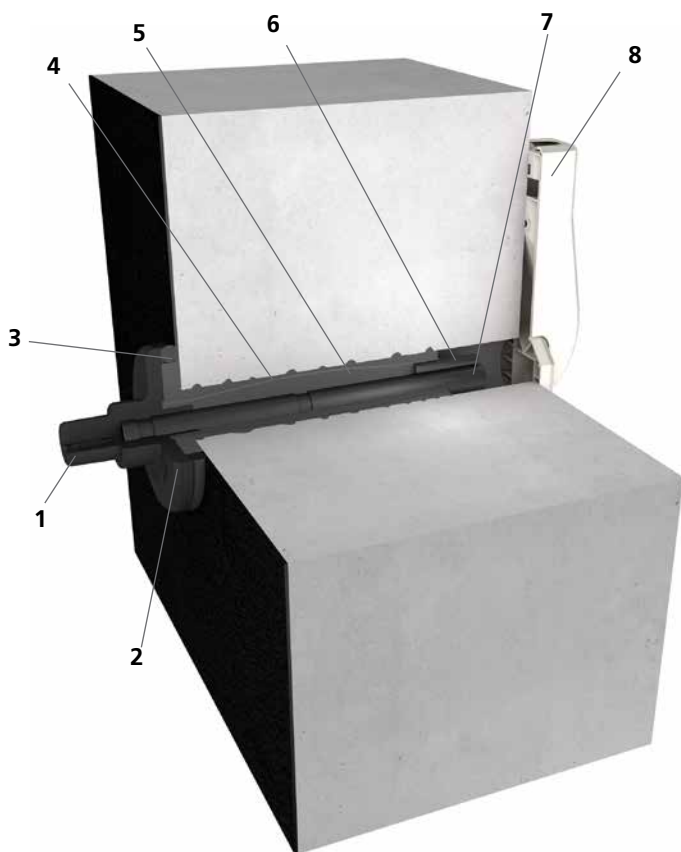

1. Sealing lips
2. Flange
covers the wall break-through and ties in the building seal on the outer wall.
3. Butyl tape
ensures a tightly sealed connection between the wall surface/building seal and the flange.
4. Membrane tube
5. Expanded 2-component resin
fills the spaces between the flange and the wall surface/building seal and between the drill hole and the pipe, including any blowholes and cavities, and creates a reliable seal.
6. Resin injection tube
ensures targeted injection of the 2-component resin from inside the building.
7. Duct
this protects the cables and allows carrier lines to be added or replaced at a later date.
8. Wall connection element
ensures a tidy finish on the inside of the building.

Single building entries – open construction

WALL ENTRY, RESIN INJECTION SYSTEM

MIS40D – FOR BUILDINGS WITH A BASEMENT							
Figure	Number of cables/ carrier lines	Suitable for carrier pipe OD (mm)	Wall thicknesses (mm)	Overall length (mm)	Overall length (mm)	Article number	GTIN
	2	5 – 7	200 – 900	1.000	MIS40D 2x5-7 BL1000 Set10	3030380163	4052487229920
	1	9 – 12	200 – 900	1.000	MIS40D 1x9- 12 BL1000 Set10	3030380164	4052487229913
	2	5 – 7	900 – 1.200	1.300	MIS40D 2x5-7 BL1300 Set10	3030391736	4052487230681
	1	9 – 12	900 – 1.200	1.300	MIS40D 1x9- 12 BL1300 Set10	3030391737	4052487230698



Accessories can be found from page 184 onwards.

FOR ELECTRICITY AND TELECOMMUNICATIONS SERVICES

Features and technical data:

- waterproof concrete, stress class 1, stress class 2
- DIN 18533 W1.1-E, W1.2-E, W2.1-E
- universal building entries with membrane injection system for drill holes in walls or floors
- sealing lips ensure gentle seal for carrier lines
- controlled ejection of resin through slit membrane hose
- variety of pre-mounted seal inserts for variable configuration
- quickly installed in just a few minutes
- no restoration of basement seal to DIN 18533 W2.1-E is necessary
- suitable for core drill hole ID 62 to 65 mm
- gas-tight and watertight up to 1 bar

Scope of supply/sales unit:

- 10 x MIS60D
- 10 x wall rosette (only for electricity)
- 10 x wall connection element (only for telecommunications services)
- 10 x 2-component resin Resinator, 150 ml
- 1 x quick tensioning device MIS60 SVS

Necessary accessories:

- cartridge gun "Side-by-Side"

Article code, article number and other, optional accessories can be found **from page 184 onwards**.

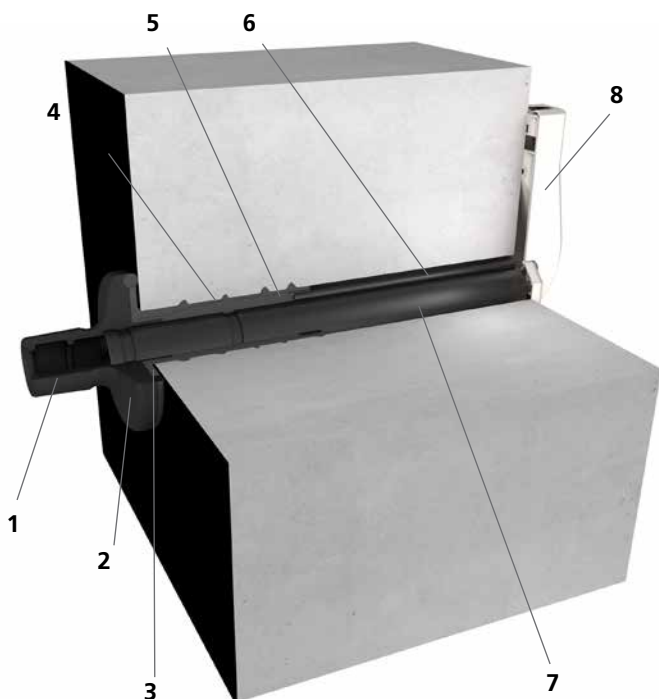

Example:



1. Sealing lips
2. Flange
covers the wall break-through and ties in the building seal on the outer wall.
3. Butyl tape
ensures a tightly sealed connection between the wall surface/building seal and the flange.
4. Membrane tube
5. Expanded 2-component resin
fills the spaces between the flange and the wall surface/building seal and between the drill hole and the pipe, including any blowholes and cavities, and creates a reliable seal.
6. Resin injection tube
ensures targeted injection of the 2-component resin from inside the building.
7. Duct
this protects the cables and allows carrier lines to be added or replaced at a later date.
8. Wall connection element
ensures a tidy finish on the inside of the building.

Single building entries – open construction

WALL ENTRY, RESIN INJECTION SYSTEM

MIS60D – FOR BUILDINGS WITH A BASEMENT							
Figure	Number of cables/ carrier lines	Suitable for carrier pipe OD (mm)	Wall thick- nesses (mm)	Overall length (mm)	Article code	Article number	GTIN
For telecommunications services							
	4	5 – 7	200 – 900	1.000	MIS60D 4x5-7 BL1000 Set10	3030380170	4052487229852
	3	10	200 – 900	1.000	MIS60D 3x10 BL1000 Set10	3030380171	4052487229845
	1	6 – 12	200 – 900	1.000	MIS60D 1x6-12 BL1000 Set10	3030380172	4052487229838
	4	5 – 7	200 – 1.300	1.300	MIS60D 4x5-7 BL1300 Set10	3030391738	4052487230704
	3	10	200 – 1.300	1.300	MIS60D 3x10 BL1300 Set10	3030391739	4052487230711
	1	6 – 12	200 – 1.300	1.300	MIS60D 1x6-12 BL1300 Set10	3030391740	4052487230728
For electricity							
	1	12 – 18	900 – 1.200	1.000	MIS60D 1x12-18 BL1000 Set10	3030380174	4052487229814
	1	18 – 24	200 – 900	1.000	MIS60D 1x18-24 BL1000 Set10	3030380175	4052487229807
	1	24 – 30	200 – 900	1.000	MIS60D 1x24-30 BL1000 Set10	3030380176	4052487229791
	1	30 – 34	200 – 900	1.000	MIS60D 1x30-34 BL1000 SET10	3030382134	4052487230124
	1	12 – 18	900 – 1.300	1.300	MIS60D 1x12-18 BL1300 Set10	3030391741	4052487230735
	1	18 – 24	200 – 1.300	1.300	MIS60D 1x18-24 BL1300 Set10	3030391742	4052487230742
	1	24 – 30	200 – 1.300	1.300	MIS60D 1x24-30 BL1300 Set10	3030391743	4052487230759
	1	30 – 34	200 – 1.300	1.300	MIS60D 1x30-34 BL1300 SET10	3030391744	4052487230766



Accessories can be found from page 184 onwards.

Single building entries – open construction

WALL ENTRY, RESIN INJECTION SYSTEM

FOR WATER, ELECTRICITY AND TELECOMMUNICATIONS SERVICES

Features and technical data:

- waterproof concrete, stress class 1, stress class 2
- DIN 18533 W1.1-E, W1.2-E, W2.1-E
- universal building entries with membrane injection system for drill holes in the wall
- flexible sealing sleeve with segmented ring technology ensures simultaneous, gentle sealing of water and communication services or electricity and communication services
- controlled ejection of resin through slit membrane hose
- quickly installed in just a few minutes
- no restoration of basement seal to DIN 18533 W2.1-E is necessary
- suitable for core drill hole ID 92 to 102 mm
- gas-tight and watertight up to 1 bar

Scope of supply/sales unit:

- 6 x MIS90
- 6 x wall rosette WAR 90

Necessary accessories:

- quick tensioning device MIS90 SVS
- cartridge gun, suitable for use with double chamber cartridges
- 2-component resin M3000 EH 300/1400

Article code, article number and other, optional accessories can be found **from page 184 onwards**.

Example:

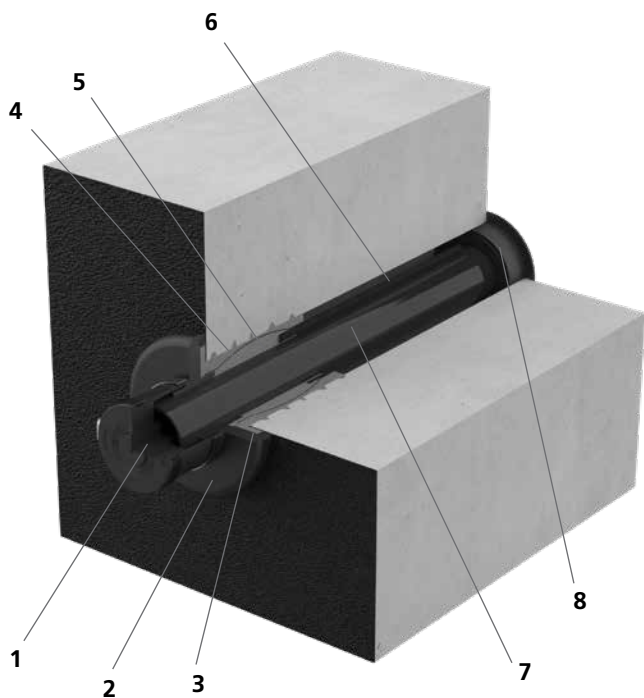

1. Sealing sleeve with segmented ring technology for sealing the carrier line.
2. Flange covers the wall break-through and ties in the building seal on the outer wall.
3. Butyl tape ensures a tightly sealed connection between the wall surface/building seal and the flange.
4. Membrane tube
5. Expanded 2-component resin fills the spaces between the flange and the wall surface/building seal and between the drill hole and the pipe, including any blowholes and cavities, and creates a reliable seal.
6. Resin injection tube ensures targeted injection of the 2-component resin from inside the building.
7. Duct this protects the cables and allows carrier lines to be added or replaced at a later date.
8. Wall rosette ensures a tidy finish on the inside of the building.

Single building entries – open construction

WALL ENTRY, RESIN INJECTION SYSTEM

MIS90D – FOR BUILDINGS WITH A BASEMENT

Figure	Number of cables/ carrier lines	Suitable for carrier pipe OD (mm)	Wall thicknesses (mm)	Overall length (mm)	Article code	Article number	GTIN
	3	1 x 24 – 52 2 x 7*	200 – 900	1.000	MIS90D 1x24-52+2x7 K SET	3030300140	4052487220262
	3	1 x 24 – 52 2 x 7*	900 – 1200	1.300	MIS90D 1x24-52+2x7 L SET	3030300142	4052487220286
	6	1 x 24 – 40 3 x 7 – 13 2 x 7*	200 – 900	1.000	MIS90D 1x24-40+3x7-13+2x5-8+2x7 K SET	3030300143	4052487220293
	6	1 x 24 – 40 3 x 7 – 14 2 x 7*	900 – 1200	1.300	MIS90D 1x24-40+3x7-13+2x5-8+2x7 L SET	3030300149	4052487220330
	7	1 x 13 – 21 3 x 7 – 13 1 x 5 – 13 2 x 7*	200 – 900	1.000	MIS90D 1x13-21+3x7-13-1x5-13+2x7 K SET	3030300144	4052487220309
	7	1 x 13 – 21 3 x 7 – 13 1 x 5 – 13 2 x 7*	900 – 1200	1.300	MIS90D 1x13-21+3x7-13-1x5-13+2x7 L SET	3030300150	4052487220347

* Speedpipe installation in flange and wall rosette and thus outside the sleeve pipe



Accessories can be found from page 184 onwards.

Single building entries – open construction

FLOOR ENTRY, RESIN INJECTION SYSTEM

FOR COMMUNICATION CABLES

Features and technical data:

- waterproof concrete, stress class 1, stress class 2
- DIN 18533 W1.1-E, W1.2-E, soil moisture
- universal building entries with membrane injection system for inclined drill holes in walls or floors
- sealing lips ensure gentle seal for carrier lines
- controlled ejection of resin through slit membrane hose
- quickly installed in just a few minutes
- suitable for core drill hole ID 40 to 50 mm
- gas-tight and watertight up to 1 bar

Scope of supply/sales unit:

- 10 x MIS40S
- 10 x wall connection element
- 10 x 2-component resin Resinator, 150 ml
- 1 x quick tensioning device MIS40 SVS

Necessary accessories:

- cartridge gun „Side-by-Side“

Article code, article number and other, optional accessories can be found **from page 184 onwards**.

Example:

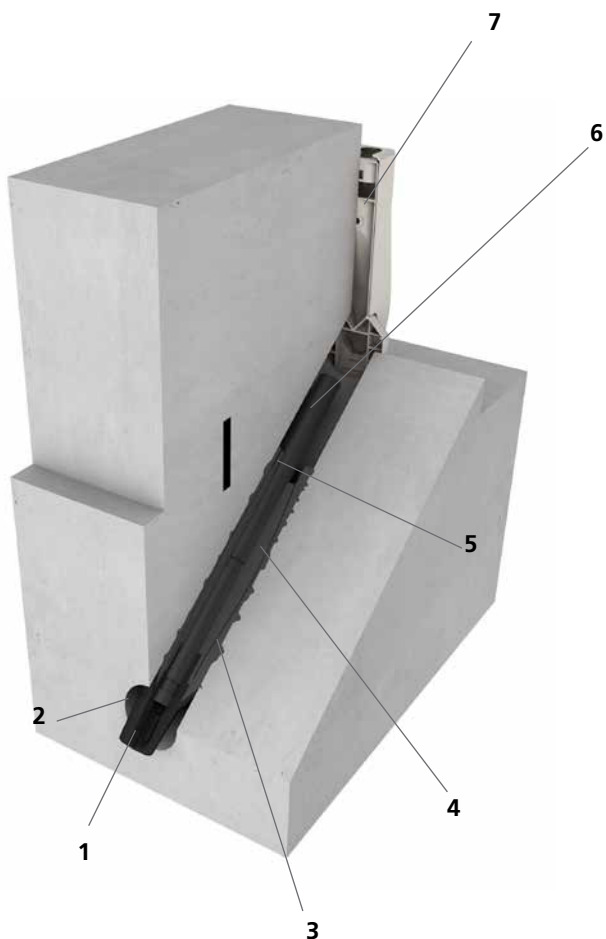

1. Sealing lips
2. Flange
remains in the drill hole and ensures controlled injection of the resin.
3. Membrane tube
4. Expanded 2-component resin
fills the spaces between the flange, drill hole and pipe, including any blowholes and cavities, and creates a reliable seal.
5. Resin injection tube
ensures targeted injection of the 2-component resin from inside the building.
6. Duct
this protects the cables and allows carrier lines to be added or replaced at a later date.
7. Wall connection element
ensures a tidy finish on the inside of the building.

Single building entries – open construction
FLOOR ENTRY, RESIN INJECTION SYSTEM

MIS40S – INCLINED BUILDING ENTRY FOR BUILDINGS WITHOUT A BASEMENT						
Figure	Number of cables/ carrier lines	Suitable for carrier pipe OD (mm)	Overall length (mm)	Article code	Article number	GTIN
	2	5 – 7	1.300	MIS40S 2x5-7 Set10	3030380167	4052487229883
	1	9 – 12	1.300	MIS40S 1x9-12 Set10	3030380168	4052487229876



Accessories can be found from page 184 onwards.

Single building entries – open construction

FLOOR ENTRY, RESIN INJECTION SYSTEM

FOR ELECTRICITY AND TELECOMMUNICATIONS SERVICES

Features and technical data:

- waterproof concrete, stress class 1, stress class 2
- DIN 18533 W1.1-E, soil moisture
- universal building entries with membrane injection system for inclined drill holes in walls or floors
- sealing lips ensure gentle seal for carrier lines
- controlled ejection of resin through slit membrane hose
- variety of pre-mounted seal inserts for variable configuration
- quickly installed in just a few minutes
- suitable for core drill hole ID 62 to 65 mm
- gas-tight and watertight up to 1 bar

Scope of supply/sales unit:

- 10 x MIS60S
- 10 x wall rosette (only for electricity)
- 10 x wall connection element (only for telecommunications services)
- 10 x 2-component resin Resinator, 150 ml
- 1 x quick tensioning device MIS60 SVS

Necessary accessories:

- cartridge gun, „Side-by-Side“

Article code, article number and other, optional accessories can be found **from page 184 onwards**.

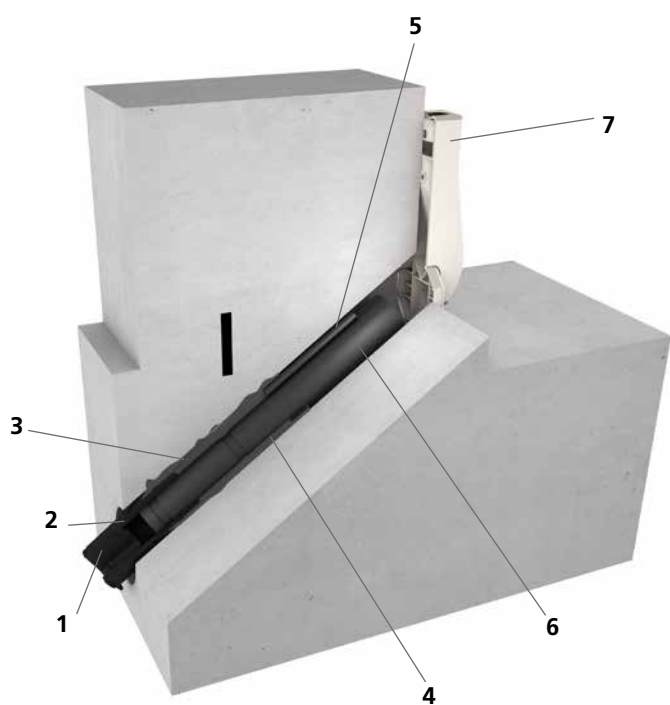

Example:



1. Sealing lips
2. Flange
remains in the drill hole and ensures controlled injection of the resin.
3. Membrane tube
4. Expanded 2-component resin
fills the spaces between the flange, drill hole and pipe, including any blowholes and cavities, and creates a reliable seal.
5. Resin injection tube
ensures targeted injection of the 2-component resin from inside the building.
6. Duct
this protects the cables and allows carrier lines to be added or replaced at a later date.
7. Wall connection element
ensures a tidy finish on the inside of the building.

Single building entries – open construction

FLOOR ENTRY, RESIN INJECTION SYSTEM

MIS60S – INCLINED BUILDING ENTRY FOR BUILDINGS WITHOUT A BASEMENT						
Figure	Number of cables/ carrier lines	Suitable for carrier pipe OD (mm)	Over-all length (mm)	Article code	Article number	GTIN
For telecommunications services						
	4	5 – 7	1.300	MIS60S 4x5-7 BL1300 Set10	3030380178	4052487229777
	3	10	1.300	MIS60S 3x10 BL1300 Set10	3030380179	4052487229760
	1	6 – 12	1.300	MIS60S 1x6-12 BL1300 Set10	3030380180	4052487229753
For electricity						
	1	12 – 18	1.300	MIS60S 1x12-18 BL1300 Set10	3030380182	4052487229739
	1	18 – 24	1.300	MIS60S 1x18-24 BL1300 Set10	3030380183	4052487229722
	1	24 – 30	1.300	MIS60S 1x24-30 BL1300 Set10	3030380184	4052487229715
	1	30 – 34	1.300	MIS60S 1x30-34 BL1300 SET10	3030382135	4052487230131



Accessories can be found from page 184 onwards.

Single building entries – open construction

FLOOR ENTRY, RESIN INJECTION SYSTEM

FOR WATER, ELECTRICITY AND TELECOMMUNICATIONS SERVICES

Features and technical data:

- waterproof concrete, stress class 1, stress class 2
- DIN 18533 W1.1-E, soil moisture
- universal building entries with membrane injection system for inclined drill holes in walls or floors
- flexible sealing sleeve with segmented ring technology ensures simultaneous, gentle sealing of water and communication services or electricity and communication services
- controlled ejection of resin through slit membrane hose
- variety of pre-mounted seal inserts for variable configuration
- quickly installed in just a few minutes
- suitable for core drill hole ID 92 to 102 mm
- gas-tight and watertight up to 1 bar

Scope of supply/sales unit:

- 1 x MIS90S
- 1 x sealing cap

Necessary accessories:

- quick tensioning device MIS90 SVS
- cartridge gun, suitable for use with double chamber cartridges
- 2-component resin M 3000 EH300/1400

Article code, article number and other, optional accessories can be found **from page 184 onwards**.

Example:

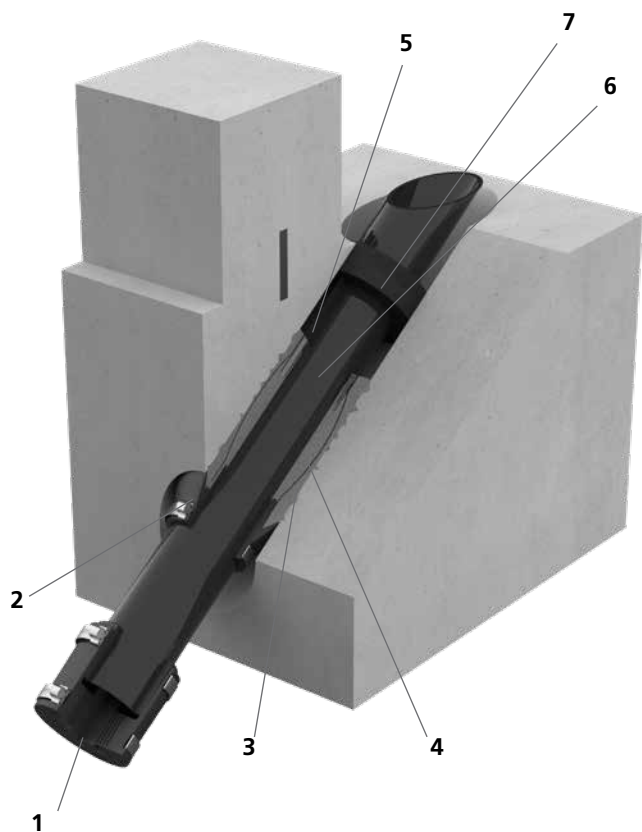

1. Sealing sleeve with segmented ring technology for sealing the carrier lines.
2. Flange remains in the drill hole and ensures controlled injection of the resin.
3. Membrane tube
4. Expanded 2-component resin fills the spaces between the flange, drill hole and pipe, including any blowholes and cavities, and creates a reliable seal.
5. Resin injection tube ensures targeted injection of the 2-component resin from inside the building.
6. Duct this protects the cables and allows carrier lines to be added or replaced at a later date.
7. Sponge rubber ring ensures a tidy finish on the inside of the building.

Single building entries – open construction

FLOOR ENTRY, RESIN INJECTION SYSTEM

MIS90S – INCLINED BUILDING ENTRY FOR BUILDINGS WITHOUT A BASEMENT

Figure	Number of cables/ carrier lines	Suitable for carrier pipe OD (mm)	Overall length (mm)	Article code	Article number	GTIN
	1	1 x 24 – 52	1.300	MIS90S 1x24-52 SET	2900200510	4052487130905
	4	1 x 24 – 40 3 x 7 – 14	1.300	MIS90S 1x24-40+3x7-13 SET	2900200520	4052487130912
	5	1 x 13 – 21 3 x 7 – 13 1 x 5 – 13	1.300	MIS90S 1x13-21+3x7-13+1x5-13 SET	2900200530	4052487133159



Accessories can be found from page 184 onwards.

Single building entries – trenchless construction

WALL ENTRY, RESIN INJECTION SYSTEM

FOR ELECTRICITY AND TELECOMMUNICATIONS SERVICES

Features and technical data:

- waterproof concrete, stress class 1, stress class 2
- DIN 18533 W1.1-E, soil moisture, W1.2-E
- universal building entries with membrane injection system for drill holes in the wall
- sealing lips ensure gentle sealing
- trenchless construction means no groundwork is necessary at the property
- controlled ejection of resin through slit membrane hose
- variety of pre-mounted seal inserts for variable configuration
- quickly installed in just a few minutes
- suitable for core drill hole ID 62 to 65 mm
- gas-tight and watertight up to 1 bar

Scope of supply/sales unit:

- 10 x MIS60ND
- 10 x wall rosette (only for electricity)
- 10 x wall connection element (only for telecommunications services)
- 10 x 2-component resin Resinator, 150 ml
- 1 x core drilling cleaning brush
- 1 x quick tensioning device MIS60 SVS

Necessary accessories:

- cartridge gun, „Side-by-Side“

Article code, article number and other, optional accessories can be found **from page 184 onwards**.

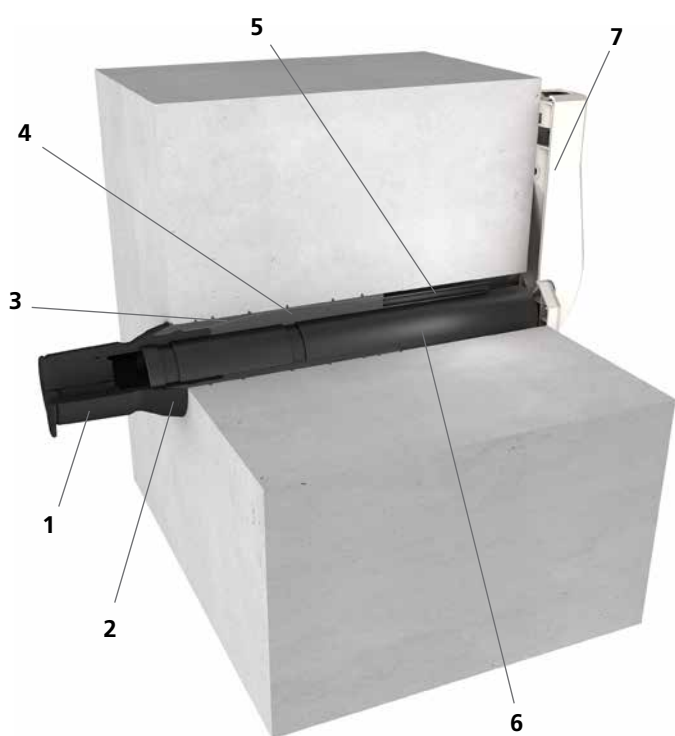

Example:



1. Sealing lips
2. Flange
controls the exit of the resin at the wall of the building.
3. Membrane tube
4. Expanded 2-component resin
fills the spaces between the flange and the wall surface and between the drill hole and the pipe, including any blowholes and cavities, and creates a reliable seal.
5. Resin injection tube
ensures targeted injection of the 2-component resin from inside the building.
6. Duct
this protects the cables and allows carrier lines to be added or replaced at a later date.
7. Wall connection element
ensures a tidy finish on the inside of the building.

Single building entries – trenchless construction





WALL ENTRY, RESIN INJECTION SYSTEM







MIS60ND – FOR BUILDINGS WITH A BASEMENT							
Figure	Number of cables/ carrier lines	Suitable for carrier pipe OD (mm)	Wall thick- nesses (mm)	Over- all length (mm)	Article code	Article number	GTIN
For telecommunications services							
	4	5 – 7	200 – 1.200	1.300	MIS60ND 4x5-7 BL1300 Set10	3030380186	4052487229692
	3	10	200 – 1.200	1.300	MIS60ND 3x10 BL1300 Set10	3030380187	4052487229685
	1	6 – 12	200 – 1.200	1.300	MIS60ND 1x6-12 BL1300 Set10	3030380188	4052487229678
For electricity							
	1	12 – 18	200 – 1.200	1.300	MIS60ND 1x12-18 BL1300 Set10	3030380190	4052487229654
	1	18 – 24	200 – 1.200	1.300	MIS60ND 1x18-24 BL1300 Set10	3030380191	4052487229647
	1	24 – 30	200 – 1.200	1.300	MIS60ND 1x24-30 BL1300 Set10	3030380192	4052487229630
	1	30 – 34	200 – 1.200	1.300	MIS60ND 1x30-34 BL1300 SET10	3030382136	4052487230148





Accessories can be found from page 184 onwards.







ACCESSORIES

MIS40 – ACCESSORIES				
Figure	Item	Article code	Article number	GTIN
	Quick tensioning device for MIS40	MIS40 SVS	5060020031	4052487236515
	Wall rosette for MIS40 sales unit = 10 Pieces	WAR40	3030300268	4052487221399
	Wall connection element for fibre optic cables	GFH WAE	3030315305	4052487226417
	Tubular guide elbow for MIS40 sales unit = 10 Pieces	MIS40 RB	5060020011	4052487236539

MIS60 – ACCESSORIES				
Figure	Item	Article code	Article number	GTIN
	Quick tensioning device for MIS60	MIS60 SVS	5060020032	4052487236508
	Wall rosette for MIS60 sales unit = 10 Pieces	WAR60	3030300269	4052487216340
	Tubular guide elbow including adapter for MIS60 (for cables up to 16 mm) sales unit = 10 pieces	MIS60 RB	3030300108	4052487220248
	Core drilling cleaning brush	MIS REB	5060050028	4052487236423
	Wall connection element for fibre optic cables	GFH WAE	3030315305	4052487226417
	Rolling gravel tip for use where there is rolling gravel fill next to the outside wall	MIS60ND RKP	5060020048	4052487236478

Resin injection system ACCESSORIES

MIS90 – ACCESSORIES				
Figure	Item	Article code	Article number	GTIN
	Quick tensioning device for MIS90	MIS90 SVS	5060020034	4052487236492
	Wall rosette for MIS90	WAR 90/100 SG 1x25-63+2x7 EPDM50	5060110602	4052487236270
	Wall rosette for MIS90	WAR 90/100 1x63+2x7 EPDM50	5060110603	4052487236263

MIS AND GFH – ACCESSORIES				
Figure	Item	Article code	Article number	GTIN
	2-component resin iM3000 including mixing nozzle sales unit = 10 pieces for GFH30, MIS40, MIS60	EH 150/700	5060050023	4052487234047
	2-component resin M3000 including mixing nozzle sales unit = 6 pieces for MIS90, MIS100	EH 300/1400	5060050022	4052487236447
	1-component sealant EGO FLOTT sales unit = 20 pieces forr OHE	EGO FLOTT	3030376512	4052487238922
	Cartridge gun for 2-component resin	MIS MW	5060050021	4052487236454
	Lubricant contents 200 ml	GML*	5020050010	4052487238564
	2-component resin RESINATOR 60 ml including mixing nozzle for GFH20	EH Resinator 60	2900001354	4052487216517
	2-component resin RESINATOR 150 ml including mixing nozzle	EH Resinator 150	2900001355	4052487216524
	Cartridge gun for "Side-by-Side" cartridges	GFH MW Side-by-Side	3030326996	4052487224932

Water exposure classes



Water exposure class W1.1-E

- **W1.1-E soil moisture**
- very water-permeable soil/
fill material very water-permeable

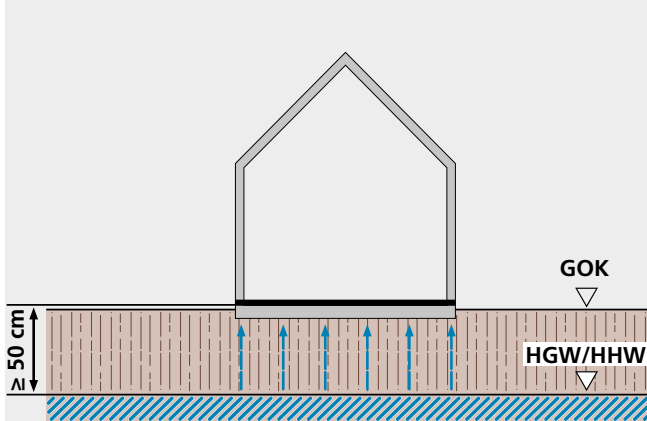

- **W1.1-E soil moisture, non-pressing water**
- very water-permeable soil/
fill material very water-permeable

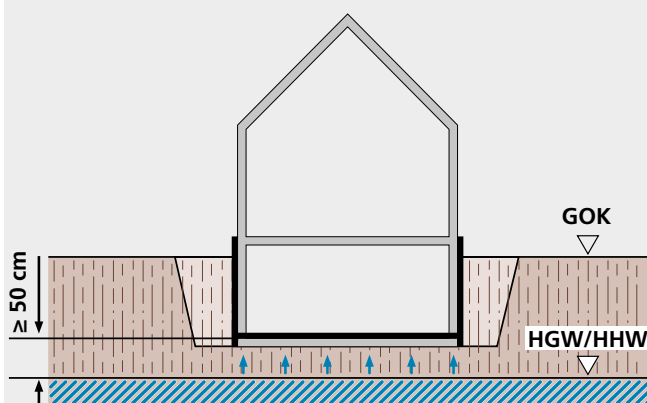

Water exposure class W1.2-E

- **W1.2-E seepage**
- less permeable foundation soil/fill material less permeable $k \leq 10^{-4}$ m/s with drainage

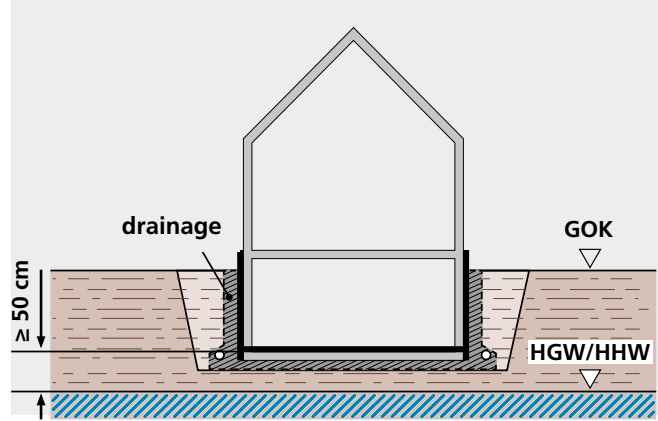



Water exposure class W2.1-E, immersion depth ≤ 3 m

- W2.1-E pressing water up to 3 m
- less permeable foundation soil/ fill material less permeable without drainage

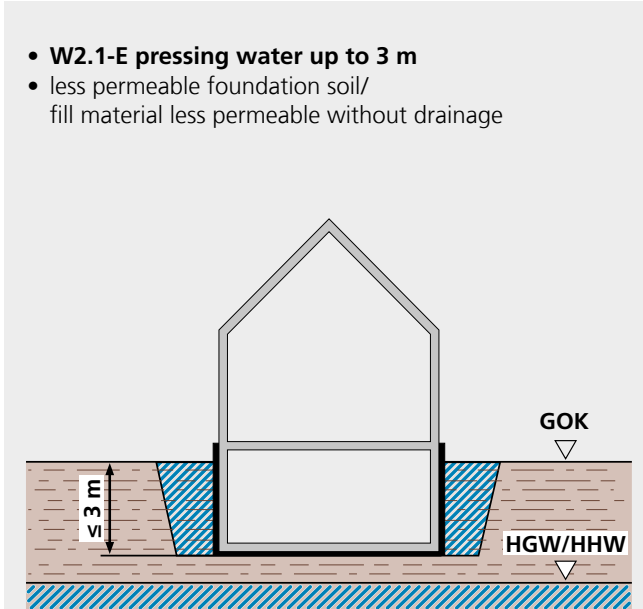

Water exposure class W2.2-E, immersion depth > 3 m

- W2.2-E pressing water more than 3 m
- less permeable foundation soil/ fill material not very water-permeable without drainage

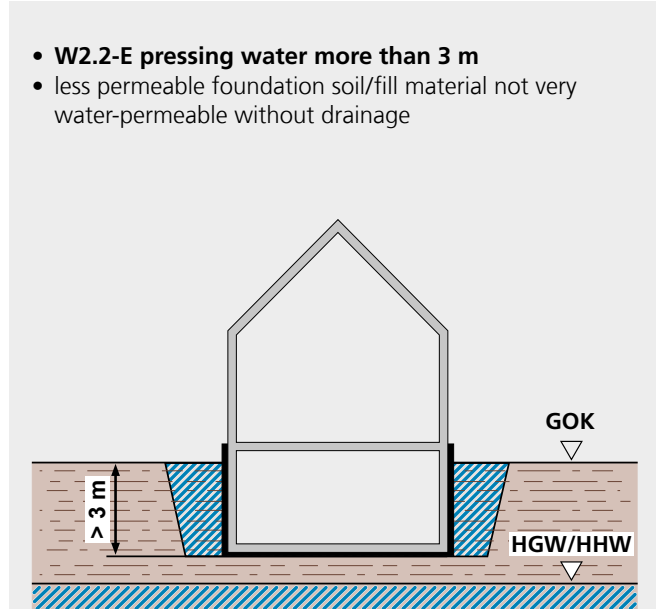

- W2.1-E groundwater up to 3 m, pressing water
- a = foundation depth

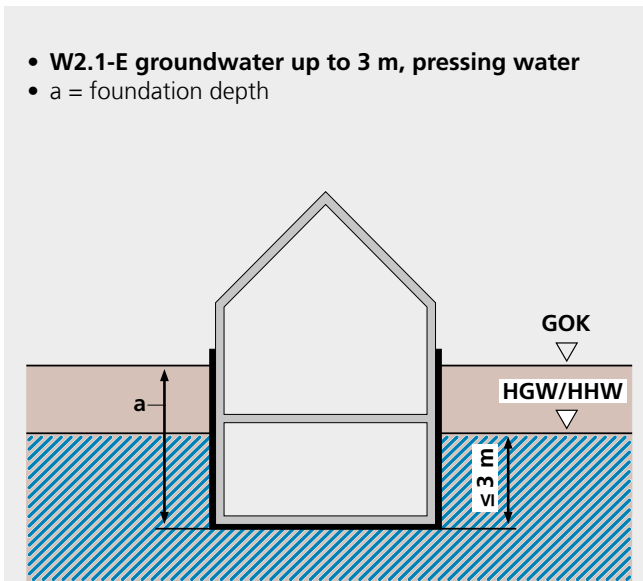

- W2.2-E groundwater/flood level more than 3 m, pressing water
- a = foundation depth

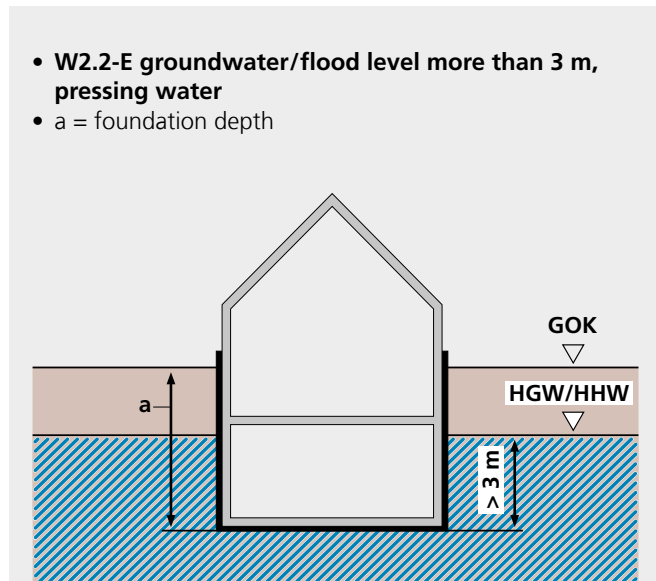

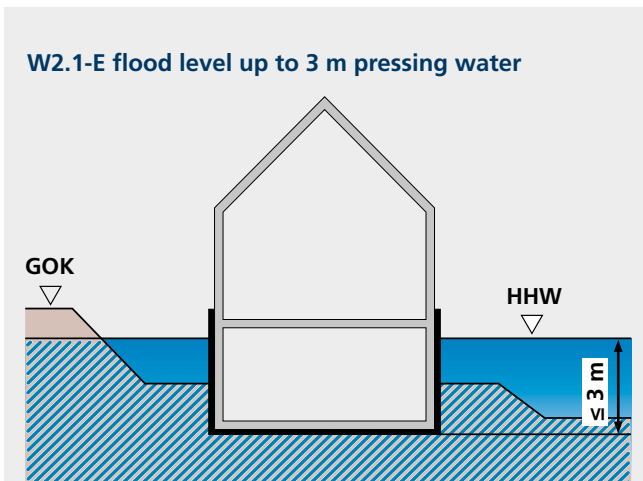

W2.1-E flood level up to 3 m pressing water



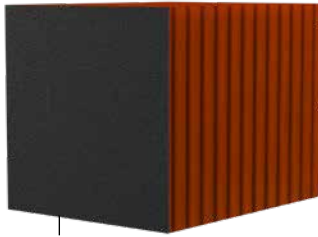
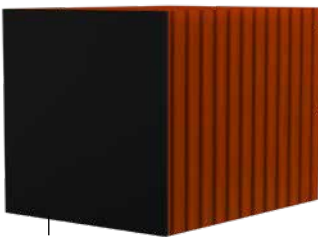
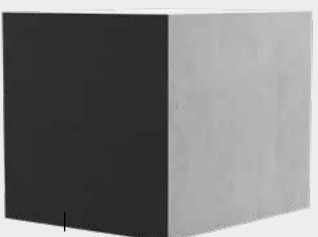
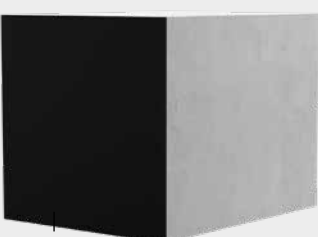

GOK: ground surface
 HGW: highest measured groundwater level
 HHW: highest measured flood level

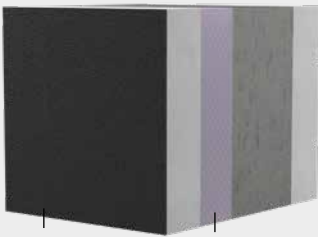
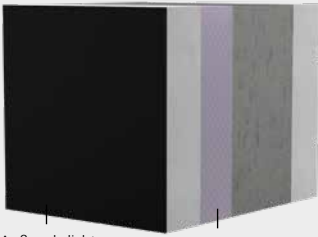
Surface sealing according to DIN 18533 Part 1

Basement wall type/ Wall structure	Sealing according to DIN 18533 – W2.1-E, Part 3, moderate exposure to pressing water, standing water 3 m	Sealing according to DIN 18533 – W2.2-E, Part 2, high exposure to pressing water, standing water > 3 m
Brick-built basement wall	<p style="text-align: center;">gemauerter Keller</p>  <p>No. 1 Außenabdichtung PMBC</p>	<p style="text-align: center;">gemauerter Keller</p>  <p>No. 5 Außenabdichtung bahnenförmig</p>
Concreted basement	<p style="text-align: center;">betonierter Keller</p>  <p>No. 2 Außenabdichtung PMBC</p>	<p style="text-align: center;">betonierter Keller</p>  <p>No. 6 Außenabdichtung bahnenförmig</p>
Double wall/Element wall	<p style="text-align: center;">Doppel-/Elementwand</p>  <p>No. 3 Außenabdichtung PMBC</p>	<p style="text-align: center;">Doppel-/Elementwand</p>  <p>No. 7 Außenabdichtung bahnenförmig</p>
Double wall/Element wall with thermal insulation	<p style="text-align: center;">Doppel-/Elementwand</p>  <p>No. 4 Außenabdichtung PMBC Wärmedämmung</p>	<p style="text-align: center;">Doppel-/Elementwand</p>  <p>No. 8 Außenabdichtung bahnenförmig Wärmedämmung</p>

Stress classes

Stress class 1	Stress class 2
	
<p>pressing water</p> <ul style="list-style-type: none"> groundwater, stratum water, flood water or other water that exerts hydrostatic pressure (temporarily or permanently) 	<p>non-standing seepage water</p> <ul style="list-style-type: none"> water that can seep through highly permeable soils ($k_f \geq 10^{-4}$ m/s) without accumulating water which is drained away in permeable soils by permanently functioning drainage in accordance with DIN 4095
<p>non-pressing water</p> <ul style="list-style-type: none"> water in liquid, dripping form with hydrostatic pressure (head of water ≤ 10 cm) 	<p>oil moisture</p> <ul style="list-style-type: none"> capillary-bound water in the soil
<p>occasionally standing seepage water</p> <ul style="list-style-type: none"> water that can accumulate on low-permeability soil strata without drainage. Foundation level of the building lies at least 30 cm above the water level assumed for design purposes 	

Waterproof concrete according to DIN 1045

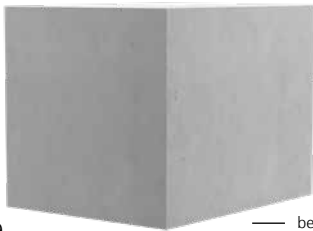
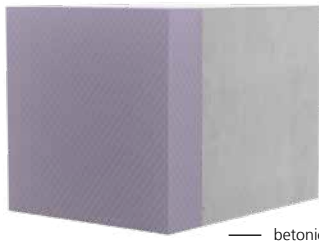
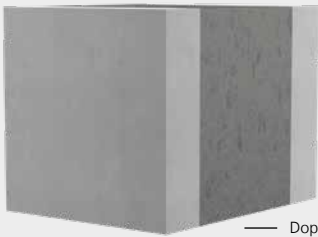
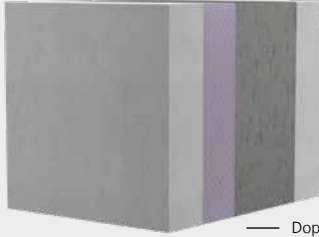
Basement wall type/ Wall structure	Without thermal insulation	With thermal insulation
Concreted basement with waterproof concrete	 <p>No. 9 — betonierter Keller</p>	 <p>No. 10 — betonierter Keller Wärmedämmung</p>
	 <p>No. 11 — Doppel-/Elementwand</p>	 <p>No. 12 — Doppel-/Elementwand Wärmedämmung</p>

If you do not find your wall structure among above examples, kindly let us have a sketch.

Pre-applied fully-bonded membranes (FBM systems) as in addition measure for waterproof concrete building seals:

FBM systems are not covered by DIN 18533 or the waterproof concrete guideline and must be designed and applied as a stand-alone construction type. Tested FBM connections on request.

General Terms and Conditions of Sale and Delivery

I. Scope of Application

1. The following Terms and Conditions of Sale and Delivery shall apply to all contracts concluded between the buyer and us concerning the sale and delivery of goods. They shall also apply to all future business relationships, even if they are not expressly agreed on once again. Deviating terms and conditions of the buyer which are not expressly recognised by us shall not be binding on us, even if we do not expressly object to them. Our Terms and Conditions of Sale and Delivery shall apply even if we carry out the buyer's order unconditionally in the knowledge of contrary or deviating terms and conditions of the buyer.

1.2 The Terms and Conditions of Sale and Delivery shall only apply to entrepreneurs in the sense of Section 14 of the German Civil Code (BGB), legal persons under public law and special funds under public law; it shall not apply to consumers (Section 13 of the BGB).

1.3 Individual agreements made with the buyer in individual cases shall always take precedence over these Terms and Conditions of Sale and Delivery. A written contract or written confirmation on our part is required for the content of such agreements.

1.4 Legally relevant declarations and notifications that are to be submitted to us by the buyer after conclusion of the contract (e.g. notifications of defects, declaration of withdrawal or reduction as well as setting of deadlines) shall be in text form in accordance with Section 126 b of the BGB to be effective. This also applies to the waiver of this text form clause.

1.5 References to the validity of statutory regulations are for the purposes of clarification only. The statutory regulations shall therefore also apply without such clarification, unless they are directly modified or expressly excluded in these Terms and Conditions of Sale and Delivery.

II. Conclusion of Contract

2.1 We may accept any order from the buyer which can be qualified as an offer to conclude a purchase contract by sending an order confirmation within two weeks or by shipping the ordered products within the same period.

2.2 For the purpose of performing a credit check on the buyer, and provided that we have demonstrated a legitimate interest, we shall be entitled to retrieve any address and financial data relating to the buyer that has been stored, including such data that can be determined on the basis of mathematical and statistical methods, via the companies Bürgel Wirtschaftsinformationen GmbH & Co. KG, Postfach 500166, 22701 Hamburg, Germany; Creditreform, Stuttgarter Str. 35, 73430 Aalen, Germany; and Bisnode D&B Deutschland GmbH, Robert-Bosch-Str. 11, 64293 Darmstadt, Germany. To enable decisions concerning the establishment, execution or termination of the contractual relationship, we shall collect or use probability figures calculated using information including address data.

2.3 Our offers shall be non-binding and subject to change, unless we have expressly designated them as binding. This shall also apply if we have provided the buyer with catalogues, technical documentation - drawings, plans, calculations, references to DIN standards, other product descriptions or documents - including in electronic form.

2.4 Acceptance by us can be declared either in text form in accordance with Section 126 b of the BGB (e.g. by order confirmation) or by delivery of the goods to the buyer.

2.5 To the best of our knowledge and experience, we are willing to provide any advice requested by the buyer, that the buyer may require in addition to product descriptions and installation instructions, but without obligation to do so. All details and information as well as applications of any kind shall not exempt the buyer from carrying out his/her own tests to determine the suitability of the products for the intended processes and purposes. Details and information provided by us are non-binding and shall not justify a separate contractual relationship or ancillary obligations from the concluded sale and delivery contract, unless otherwise expressly agreed in writing (text form in accordance with Section 126 b of the BGB is sufficient).

III. Terms and Conditions of Payment - Prices

3.1 Unless otherwise agreed in individual cases, our current prices at the time the contract is concluded apply on an ex-works basis (EXW in accordance with Incoterms 2020) ex-warehouse. Our prices do not include the statutory value added tax. We shall disclose the amount of value added tax applicable on the invoice date separately in our invoice. Unless a fixed price agreement has been made, we reserve the right to make reasonable price adjustments due to changes in wage, raw material, material and distribution costs for deliveries made three months or later after conclusion of the contract.

3.2 In the case of sale by dispatch, the buyer shall bear the transport costs ex-warehouse and the costs of any transport insurance requested by the buyer. Any customs duties, fees, taxes or other public charges shall be borne by the buyer. Should the shipment be made using reusable pallets, these shall only be loaned to the buyer; the buyer shall undertake to properly return or replace such pallets.

3.3 The purchase price shall be due and payable without deductions within 10 days of invoicing and delivery of the goods. Cash discounts are not permitted unless otherwise agreed in writing between us and the buyer. A payment shall not be deemed to have been made until we have the amount at our disposal.

3.4 Upon expiry of the above payment period, the buyer shall be in default without the need for a separate reminder. The purchase price shall bear interest at the applicable statutory rate during the period of default. We reserve the right to assert further compensation claims caused by delay.

3.5 The buyer shall only be entitled to set-off, even if complaints or counterclaims are being made, if the counter-claims have been determined in a final and legally binding manner, have been acknowledged by us or are undisputed. The buyer shall only be entitled to exercise a right of retention if his/her counter-claim is based on the same contractual relationship. We shall be entitled to exercise a right of retention on all receivables arising from the business relationship with the buyer.

3.6 Should our claim to the purchase price be jeopardized by the buyer's inability to pay after conclusion of the contract, we are entitled to refuse performance and, with a deadline set if necessary, to withdraw from the contract (Section 321 of the BGB).

IV. Delivery, Performance Time and Delivery Delays

4.1 Delivery dates or periods which have not expressly been agreed as binding are exclusively non-binding information. Unless otherwise agreed, delivery is made on an ex-works basis (EXW in accordance with Incoterms 2020) from the Hermaringen warehouse, which is also the place of performance. The delivery time quoted by us shall only commence when the technical issues have been clarified. Similarly, the buyer is obliged to fulfil all of the obligations to which he is subject, both properly and in a timely manner. We reserve the right to the defence of lack of performance of the contract.

4.2 In the event that a delivery delay for which we are responsible – and where a fault on the part of our representatives or vicarious agents is to be ascribed to us – is due to a grossly negligent or intentional breach of contract on our part or a slight breach of a fundamental contractual obligation on our part, we shall be liable in accordance with the statutory provisions, with the proviso that in such cases our compensation liability is limited to the foreseeable, typically occurring damage or loss.

4.3 A delivery delay for which we are responsible, which shall be based solely on the culpable breach of a non-fundamental contractual obligation, shall limit the buyer's compensation claim to 25% of the value.

4.4 Should we be completely or partially prevented from fulfilling our obligations due to a force majeure event, we shall be released from fulfilling our contractual obligations until cessation of the force majeure event. We shall however immediately inform the buyer thereof insofar as he/she is not also prevented from fulfilling the contract by a force majeure event. The impossibility of an adequate supply of utilities such as electricity, heating, etc., as well as strikes and lockouts, the outbreak of an epidemic or pandemic, as well as terrorist attacks, earthquakes and/or drought – unless they are of short duration or by our fault – shall be equated to a force majeure event. In the case of a force majeure event, we shall be entitled to postpone our delivery time. In this respect, the buyer shall not be entitled to withdraw from the contract or to claim damages; our liability shall be excluded. Should delivery not be possible within a reasonable period of time or if the buyer can credibly demonstrate that a later delivery is not reasonable for him/her, he/she shall have the right to withdraw from the contract. Any claims of the buyer over and above this, in particular compensation claims, are excluded.

V. Acceptance

5.1 The buyer shall undertake to carry out all actions required for acceptance of our delivery. In the event of a culpable breach of this obligation by the buyer, he/she shall be liable to us for any additional expenses. In such cases, we also reserve the right to assert further compensation claims.

5.2 Should the buyer's acceptance of the delivery be delayed by more than 14 days, we shall grant, in writing, a grace period of 14 days for the acceptance; at the same time, we shall issue a notification that acceptance will be rejected if this defined period expires without the action having been carried out. Should the buyer allow the defined grace period to elapse without the action having been carried out, we shall be entitled to withdraw from the purchase contract by means of a written declaration, or to demand compensation for non-performance. Should the buyer continue to refuse acceptance, or if he/she is clearly unable to pay the purchase price even if a grace period is granted, there shall be no requirement to grant a grace period.

5.3 In such cases, we shall be entitled to claim our loss of profits amounting to 10 % of the agreed purchase price, unless the buyer proves that we incurred a lower loss. Irrespective of this, we shall be entitled to prove and claim higher damages.

VI. Warranty

6.1 The buyer's claims due to defects only exist if the buyer has duly complied with his/her inspection and complaint obligations in accordance with Section 377 of the German Commercial Code (HGB). If the buyer makes changes to our products, fails to follow our operation, installation and maintenance specifications or safety instructions, or does not follow them sufficiently, or uses parts or consumables that have not been approved by us, our warranty obligation shall no longer apply, unless the buyer can prove that the defect concerned is not the result of one of these circumstances. Otherwise, our installation instructions and warranty conditions shall apply.

6.2 If there is a defect in the goods for which we are responsible, we shall undertake to effect subsequent performance – excluding the rights of the buyer to withdraw from the contract or to reduce the purchase price (reduction) – unless we are entitled to refuse to effect subsequent performance due to the statutory regulations.

6.3 The buyer must grant us a reasonable period of time for the subsequent performance. The subsequent performance may be effected either by removal of the defect (subsequent improvement) or by delivery of new goods. In the case of the removal of a defect, we shall bear the necessary costs provided that these do not increase because the goods of the contract are at a location other than the place of performance. We shall not accept claims for reimbursement of expenses if our defective product is combined with another item in such a way that a new functional purpose is created. At our reasonable discretion, we shall be entitled to determine the type of subsequent performance. Any subsequent performance by us shall take place without recognition of a legal obligation, unless the defect has been recognised by us. If the subsequent performance fails, the buyer may, at his/her discretion, demand a reduction in the purchase price (reduction) or declare his/her withdrawal from the contract. The subsequent improvement shall be deemed to have failed after the second unsuccessful attempt, unless further attempts to achieve an improvement are appropriate and reasonable for the buyer in view of the nature of the contractual item.

General Terms and Conditions of Sale and Delivery

6.4 Compensation claims according to statutory provisions due to a defect may only be asserted by the buyer if the supplementary performance fails. The buyer shall not be entitled to demand compensation claims or a reduction in the purchase price in the case of insignificant defects.

6.5 The claims of the buyer due to defects in the purchased item shall lapse 5 years after delivery of the goods to the buyer if they were used for construction work in accordance with their normal method of utilisation and this has caused their defectiveness. This shall also apply to claims of the buyer for compensation or compensation instead of service, and due to all other damage to the buyer's rights arising from the defect; it shall not, however, apply to damage to the life, limb or health of the buyer, or to cases in which we are responsible for the defect as a result of wilful intent or gross negligence, including on the part of our vicarious agents.

6.6 Claims due to defects shall not exist in the case of natural wear and/or damage occurring after the transfer of risk as a result of faulty and/or negligent handling of unsuitable equipment and/or inadequate water quality or incorrect installation. Moreover, claims for defects shall not exist in the case of chemical and/or electrochemical influences on our products, unless we are responsible for them. Our warranty and/or liability shall particularly be void if accessories that have not been approved by us are installed with our products. The contrary shall only apply if the warranty case and/or liability is demonstrably not due to one of the aforementioned reasons for exclusion.

VII. Liability

7.1 Unless otherwise stated in these Terms and Conditions of Sale and Delivery, including the following provisions, or in a separate written agreement between us and the buyer, we shall be liable – for whatever legal reason – in the event of a violation according to the applicable statutory regulations.

7.2 Insofar as we intentionally or through gross negligence violate a contractual obligation or an essential contractual obligation through simple negligence, our obligation to pay compensation shall be restricted to foreseeable damage that is typical for the contract. Essential contractual obligations are such obligations whose fulfilment is essential for the proper execution of the contract and on whose observance the buyer can regularly rely. In all cases of other slightly negligent breaches of obligations – except for those in Section 4.3 – our liability shall be excluded.

7.3 The regulations of the previous paragraphs shall apply to all compensation claims (and particularly to compensation in addition to service and compensation instead of service), regardless of the legal basis, particularly when arising as a result of defects, a breach of obligations from the obligatory relationship, or tortious acts. They shall also apply to claims for compensation of wasted expenditure. However, liability for delivery delays shall be determined exclusively in accordance with Section 4. of these Terms and Conditions of Sale and Delivery. Our unlimited liability as a result of intent, gross negligence, according to the regulations of the German Product Liability Act, any warranty or injury to life, limb or health shall remain unaffected by this limitation of liability.

7.4 A change in the burden of proof that is to the disadvantage of the buyer is not connected to the previous regulations.

VIII. Retention of Title, Use of Our Intellectual Property

8.1 We hereby reserve the title, copyright and all other rights of use to all pictures, calculations, drawings and other documents. The buyer may only pass these on to third parties with our prior written consent.

8.2 The delivery item shall remain our property up to the point at which all our claims against the buyer arising from the business relationship have been satisfied.

8.3 The buyer shall be permitted to process or remodel the delivery item ("processing"). Processing shall be carried out for us. The retention of title shall extend to the products resulting from the processing, mixing or combination of our products at their full value, whereby we shall be considered to be the manufacturer. In case of processing, mixing or combining our goods with products of a third party, the title of which is retained, we shall acquire co-ownership in such processed, mixed or combined goods in proportion to the invoice values. Otherwise, the same shall apply to the resulting product as to the goods delivered under retention of title. To the extent that we acquire ownership or co-ownership, we shall keep the goods safe for the buyer with the due care and diligence of a prudent businessman.

8.4 In the event that the delivery item or the new goods are sold, the buyer hereby assigns to us by way of security his/her claims arising from the resale against his/her customer, plus all ancillary rights, without the need for any additional special declarations. We expressly accept this assignment. The assignment shall apply inclusive of any balance receivables. However, the assignment shall only apply to the amount that corresponds to the price of the delivery item invoiced by us. The share of the receivable assigned to us must be satisfied as a matter of priority.

8.5 If the buyer combines the delivery item or the new goods with property, he/she shall – without the need for any additional special declarations – also assign his/her receivables to which he/she is entitled as remuneration for the combination, at the amount that corresponds to the price of the delivery item invoiced by us. We also expressly accept this assignment.

8.6 Until further notice, the buyer shall be entitled to collect receivables assigned to us. The buyer shall immediately forward payments made towards the receivables assigned to us, up to the amount of the secured receivable. If there is a legitimate interest, and particularly in the case of default of payments, suspension of payments, opening of insolvency proceedings, protest of a bill, or substantiated evidence of over-indebtedness or impending insolvency of the buyer, we shall be authorised to withdraw the buyer's right of collection. Additionally, following prior warning and with a reasonable deadline adhered to, we may disclose the security assignment, make use of the assigned receivables, and demand disclosure of the security assignment by the buyer to his/her customers. If a justified interest is substantiated, the buyer must provide us with the information necessary to assert his/her rights in respect of his/her customers, and surrender the necessary documents.

8.7 For the duration that the retention of title is in place, the buyer shall be prohibited from pledging or assignment as security. In the event of seizure, confiscation or other official orders or acts of intervention by third parties, the buyer must notify us immediately. The resale of the delivery item or the new goods is only permitted for resellers in the ordinary course of business, and only under the condition that the proceeds from the delivery item are paid to the buyer. The buyer must also agree with the customer that the customer shall only acquire ownership once this payment is made.

8.8 If the realisable value of all security rights to which we are entitled exceeds the amount of the secured claims by more than 10%, we shall release a corresponding part of the security rights at the buyer's request. It shall be assumed that the conditions of the previous sentence have been met if the estimated value of the securities to which we are entitled reaches or exceeds 150% of the value of the secured claims. We shall be entitled to choose between the various security rights for release.

8.9 If the buyer breaches obligations – particularly in respect of default of payment – we shall be authorized, without setting a deadline, to demand surrender of the delivery item or the new goods and/or, with a deadline set if necessary, to withdraw from the contract. The buyer shall undertake to surrender possession. A demand for the surrender of the delivery item/of the new goods shall not constitute a declaration of withdrawal on our part, unless expressly stated.

IX. Data Protection, Confidentiality

9.1 The execution of contracts concluded between us and the buyer shall take place in compliance with legal provisions such as the German Federal Data Protection Act (BDSG), the German Telecommunications-Telemedia Data Protection Act (TTDSG) and the European General Data Protection Regulation (GDPR). We give our assurance that the stored data will only be stored for internal use. Otherwise, data will only be transferred to external service providers in compliance with data protection regulations. If necessary, we will conclude separate agreements in which the external service providers undertake to comply with the applicable statutory regulations. Within the scope of our legitimate interest, we exchange creditworthiness information within INDUS Holding AG, Kölner Straße 32, 51429 Bergisch Gladbach and the companies affiliated with us there, as well as with credit agencies. In this context, we refer to the latest version of the data protection statement published on our homepage at www.hauff-technik.de/datenschutz.html.

9.2 Both contracting parties undertake to treat information and data from their mutual business relationship confidentially. In the event of an infringement, we reserve the right to claim damages and take action under criminal law.

9.3 The obligation of confidentiality towards the buyer does not apply to companies affiliated with us within the meaning of Section 15 of the German Stock Corporation Act (AktG) or in the event that the content of the contract/information is already known or generally accessible.

X. Legal Venue, Choice of Law

10.1 Our registered office shall be the place of performance and jurisdiction for deliveries and payments and for all disputes arising between us and the buyer based on the contracts concluded between us and the buyer. The same shall apply to cross-border deliveries resulting from contractual relationships. We shall also be entitled, however, to sue the buyer at the court where he/she has his/her general place of jurisdiction.

10.2 The relations between the contracting parties shall be determined exclusively in accordance with the law of the Federal Republic of Germany. The application of international conventions concerning the sale of movable goods and the UN Convention on Contracts for the International Sale of Goods (CISG) are excluded.

10.3 The German version of the contents of our General Terms and Conditions of Sale and Delivery shall apply exclusively, even if there are versions in other languages.

XI. Miscellaneous

11.1 Should individual provisions of these General Terms and Conditions of Sale and Delivery be or become wholly or partially invalid, void or unenforceable, this shall not affect the validity of the remaining General Terms and Conditions of Sale and Delivery.

11.2 The parties agree that in place of the invalid, void or unenforceable provision, a valid and enforceable provision should be created, the effect of which comes as close as possible to the economic objective that the contracting parties were pursuing with the invalid, void or unenforceable provision.

Version: June 2023

Hauff-Technik UK Limited

Units 1 & 2 Carrwood Road
Chesterfield
S41 9QB, United Kingdom

Tel. +44 (0) 1246 792018

htuk.office@hauff-technik.com